

Hiflex



Product Documentation

English

cod. 272055 – rev. 24.07.2002

INDEX

1 – The serie	1
1.1 – Unit coding	1
1.2 – Main features and advantages	1
2 – Configuration	2
2.1 – Version A	2
2.2 – Version W	3
2.3 – Version D	4
2.4 – Version H	5
2.5 – Version F	6
2.6 – Version C	7
2.7 – Hiflex Constant versione A	7
2.8 – Hiflex Constant versione W	7
2.9 – Air control	9
2.10 – Dimensions and accessibility	9
3 – Operating limits	10
4 – Component features	11
4.1 – Fan	11
4.2 – Compressor	11
4.3 – Coils	11
4.4 – Frame and panels	11
4.5 – Filters	12
4.6 – Refrigerants	12
4.7 – Electric board	12
4.8 – Accessibility	12
4.9 – Control system	12
4.10 – Packing	13
4.11 – Product quality and safety	13
5 – Condensing section	14
5.1 – Air condensers	14
5.2 – Water condensers	17
5.3 – Dry coolers	17
6 – Technical remarks	20
6.1 – Fluid R407C	20
7 – Electrical characteristics	22
8 – Aeraulic features	27
8.1 – Useful available heads	27
9 – Sound Pressure Level	30
9.1 – Sound emission spectra	30
10 – Technical data and performances	35
11 – Optional	91
11.1 – Filters	91
11.2 – HP–FAN	93
11.3 – Reheating and humidity control (optional)	96
11.4 – Humidification and dehumidification system	103
11.5 – Water control valve (models W/H)	104
11.6 – Flooding alarm (Liquistat)	104
11.7 – Smoke alarm (Smokestat)	104
11.8 – Fire alarm (Firestat)	104

11.9 – Fresh air	105
11.10 – Suction and delivery ducts	105
11.11 – Deadening cartridges for delivery channels – Silent Carts (models Over)	106
11.12 – Delivery plenum with horizontal throw (models Over)	107
11.13 – Grid with one deflection rank (models Over)	107
11.14 – Base–frames: models TBD	107
11.15 – Base–modules (models Over)	107
11.16 – Automatic condensate drain pump	107
11.17 – Non–return valve (models A and D)	108
11.18 – Additional temperature and humidity sensor (EEAP)	108
11.19 – Microprocessor control with graphic display HIROMATIC G	108
11.20 – Deadening insulation coating	109
11.21 – Duct with deadening insulation coating	109
11.22 – Power supply at 230/3/50	110
11.23 – Special packing	110
11.24 – Air intake from the bottom (models Over)	110
11.25 – Accessory combination	110
12 – Overall dimensions	111



The **HIFLEX Product Documentation** can also be surfed on the Web at the address: www.HIROSS.IT/pde/TDS/Hiflex

This document is password–protected. Ask for the password to your Dealer/Area Manager.

1 – The serie

HIFLEX is the new series of air conditioners developed by **Liebert HIROSS** to allow maximum flexibility of application in technological environments, from data processing centers to manned control rooms and electronic centers for telecommunication. This series includes units with a rated cooling capacity ranging from 5 to 40 kW.

1.1 – Unit coding

A mark with four alphanumeric characters identifies the model.

4LOA

is the numeric value identifying the size of the unit (4–6–8–) Models 5–7–9 are double.

M Small type – R22

S Small size – R22

L Large size – R22

P Small size – R407C

G Large size – R407C

U underfloor air flow (Under)

O upward air flow (Over)

C constant

A Direct expansion unit with external air cooled condenser

C Chilled water unit

D Direct expansion unit and chilled water unit (DUALFLUID) with external air cooled condenser

F Direct expansion unit and chilled water unit (FREECOOLER) with water cooled condenser – one water circuit.

H Direct expansion unit and chilled water unit (DUALFLUID) with water cooled condenser

W Direct expansion unit with water cooled condenser

1.2 – Main features and advantages

The air conditioners of HIFLEX series have the following features:

- ✓ High sensible cooling capacity; high EER (Energy Efficiency Ratio)
- ✓ Total front accessibility for the maintenance
- ✓ Low acoustic emission
- ✓ Exact electronic control by microprocessor
- ✓ Small plant dimensions

2 – Configuration

Here is a short description of the peculiar features of each of the six available versions.

2.1 – Version A

Direct expansion air–condensed units

Refrigerating circuit

The 4–6–8 models are provided with a **single refrigerating circuit**, the units 5–7–9 have two refrigerating circuits. The refrigerating circuit includes the compressor and the thermal expansion valve with an external equalizer (or in the M version, the capillary) controlling the refrigerant flow to the evaporator so as to keep a steady overheating degree. Before the thermal expansion valve there is a **sight glass** enabling the visual check of the refrigerant charge. A **dryer filter** is installed in the liquid line for better cleaning and less humidity in the circuit. The welded steel **liquid receiver** is available in the refrigerating circuit to enable the constant and even refrigerant flow to the expansion valve. On–off valves are installed as standard to help the extraordinary maintenance of the circuits.

For a safe operation, during the start–up it is advisable to install the **non–return valve** (supplied as optional on request) on the connection of the refrigerant with the external condenser to protect the compressor from unexpected refrigerant migrations (see installation diagramme). A suitably sized **safety valve** is installed on the liquid receiver; the valve is equipped with flanged connections to allow the refrigerant to be discharged outside through suitable pipes. All low temperature parts of the refrigerating circuit are insulated. The refrigerating circuit is also provided with a high pressure switch and a low pressure switch. The **low pressure switch** has automatic resetting, whereas – for safety reasons due to possible high pressure in the compressor – the **high pressure switch** has manual resetting. The pressure switch calibration values are shown in the installation manual supplied with the machine.

The units are supplied without the external condenser and with nitrogen–pressed refrigerating circuit. The customer himself has to make the connection with the external condenser and the refrigerant charging. All the instructions for the necessary operations are contained in the installation manual.

The units are supplied without the external condenser and with nitrogen–pressed refrigerating circuit. The customer himself has to make the connection with the external condenser and the refrigerant charging. All the instructions for the necessary operations are contained in the installation manual.

External condensing unit

The units are coupled with the **air condensers** of **Liebert HIROSS** wide range in the versions with standard axial fans and with low noise axial fans. For technical data and performances refer to the relevant technical documentation. The following paragraphs describe the suggested couplings for the HIFLEX units as a function of the outdoor air temperature. The data given below are approximate and must always be verified on the basis of the specific performances and working conditions required.

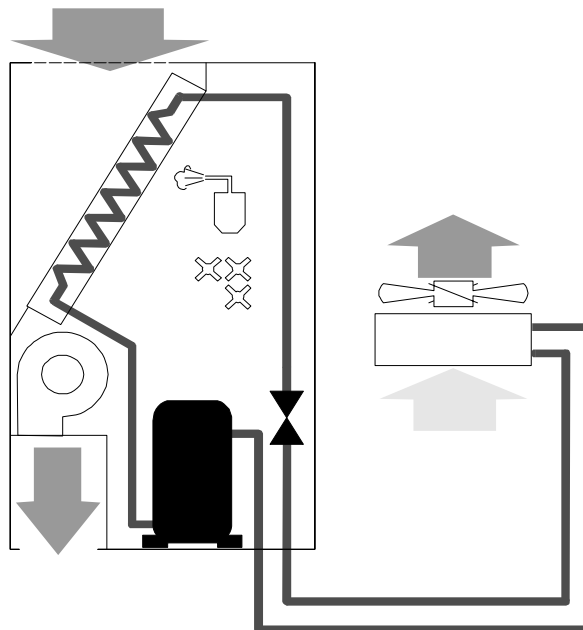

2.2 – Version W

Direct expansion water–condensed units

Refrigerating circuit

The 4–6–8 models are provided with a **single refrigerating circuit**, the units 5–7–9 have two refrigerating circuits. The refrigerating circuit includes the compressor and the thermal expansion valve with an external equalizer controlling the refrigerant flow to the evaporator so as to keep a steady overheating degree. Before the thermal expansion valve there is a **sight glass** enabling the visual check of the refrigerant charge. A **dryer filter** is installed in the liquid line for better cleaning and less humidity in the circuit. **On–off valves** are installed as standard to help the extraordinary maintenance of the circuits.

A suitably sized **safety valve** is installed after the condenser; the valve is equipped with flanged connections to allow the refrigerant to be discharged outside through suitable pipes. All low temperature parts of the refrigerating circuit are insulated. The refrigerating circuit is also provided with a high pressure switch and a low pressure switch. The **low pressure switch** has automatic resetting, whereas – for safety reasons due to possible high pressure in the compressor – the **high pressure switch** has manual resetting. The pressure switch calibration values are shown in the installation manual supplied with the machine.

Condenser

The units are provided with a built–in stainless steel water condenser with braze–welded plates; this advanced exchanger type gives the highest efficiency in heat exchange. In addition, a certain oversizing of the exchanger has been provided so as to reduce pressure drops (and energy consumption of the water pump) as much as possible and thus to allow the unit to operate with the external chiller in closed circuit, even at high outdoor temperatures.

The units shall operate with **throwaway water**, **tower water** or **water in closed circuit with external chiller**. In the operation with closed circuit, the water is cooled by the outdoor air in a heat exchanger; in this case, to avoid unwished ice formation during winter, it is advisable to obtain the mixture always with a glycol percentage (refer to the installation manual for the suitable percentages). The circulation of the water–glycol mixture is forced (the pump is not supplied). If throwaway water or tower water is used, when installing the unit fit a **mechanical filter** on the water line to protect the condenser against possible impurities contained in the water (for the condenser cleaning see the installation manual).

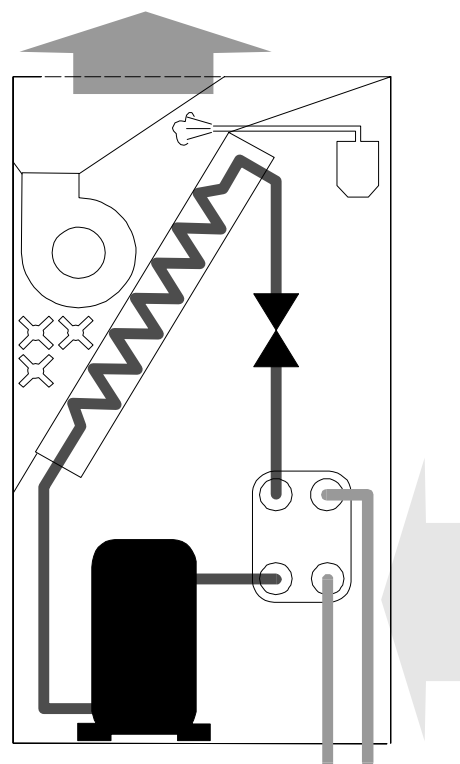

2.3 – Version D

*Air–condensed dualfluid units***Refrigerating circuit**

The 8 models are provided with a **single refrigerating circuit**, the units 9 have two refrigerating circuits. The refrigerating circuit includes the compressor and the thermal expansion valve with an external equalizer controlling the refrigerant flow to the evaporator so as to keep a steady overheating degree. Before the thermal expansion valve there is a **sight glass** enabling the visual check of the refrigerant charge. A **dryer filter** is installed in the liquid line for better cleaning and less humidity in the circuit. The welded steel **liquid receiver** is available in the refrigerating circuit to enable the constant and even refrigerant flow to the expansion valve. On–off valves are installed as standard to help the extraordinary maintenance of the circuits. For a safe operation, during the start–up it is advisable to install the non–return valve (supplied as optional on request) on the connection of the refrigerant with the external condenser to protect the compressor from unexpected refrigerant migrations (see installation diagramme).

A suitably sized safety valve is installed on the liquid receiver; the valve is equipped with flanged connections to allow the refrigerant to be discharged outside through suitable pipes. All low temperature parts of the refrigerating circuit are insulated. The refrigerating circuit is also provided with a high pressure switch and a low pressure switch. The low pressure switch has automatic resetting, whereas – for safety reasons due to possible high pressure in the compressor – the high pressure switch has manual resetting. The pressure switch calibration values are shown in the installation manual supplied with the machine.

External condensing unit

The units are coupled with the **air condensers** of **Liebert HIROSS** wide range in the versions with standard axial fans and with low noise axial fans. For technical data and performances refer to the relevant technical documentation. The following paragraphs describe the suggested couplings for the HIFLEX units as a function of the outdoor air temperature. The data given follow are approximate and must always be verified on the basis of the specific performances and working conditions required.

Hydraulic circuit

The unit is provided with a **3–way modulating valve**, complete with incremental motor for the water flow control to the coil; the opening or closing signals, generated by the electronic control, adjust the valve in order to keep the ambient temperature at the required value. Through a series of menus it is possible to set all parameters on the control for a correct adjustment, i.e. set–points, proportional bands, proportional or proportional+integral adjustment, integrating factor and valve feature. It is possible to adjust the valve manually in closing position (coil side) by means of a suitable wrench.

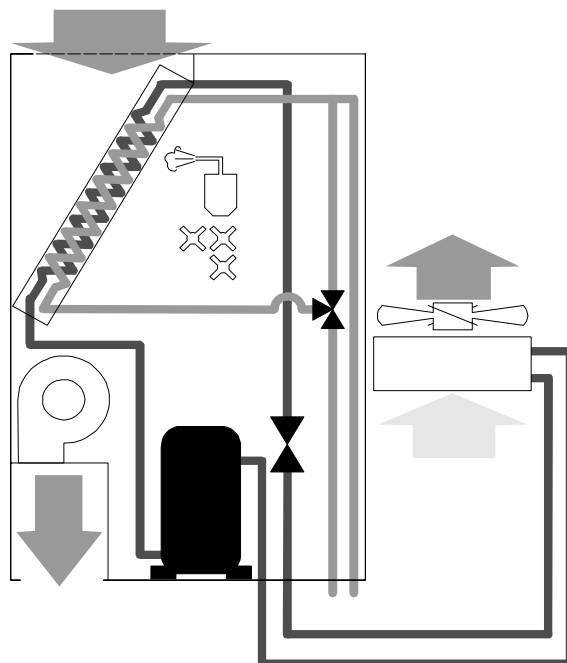

2.4 – Version H

Water–condensed dualfluid units

Refrigerating circuit

The 8 models are provided with a **single refrigerating circuit**, the units 9 have two refrigerating circuits. The refrigerating circuit includes the compressor and the thermal expansion valve with an external equalizer controlling the refrigerant flow to the evaporator so as to keep a steady overheating degree. Before the thermal expansion valve there is a **sight glass** enabling the visual check of the refrigerant charge. A **dryer filter** is installed in the liquid line for better cleaning and less humidity in the circuit. **On–off valves** are installed as standard to help the extraordinary maintenance of the circuits. A suitably sized **safety valve** is installed after the condenser; the valve is equipped with flanged connections to allow the refrigerant to be discharged outside through suitable pipes. All low temperature parts of the refrigerating circuit are insulated. The refrigerating circuit is also provided with a high pressure switch and a low pressure switch. The low pressure switch has automatic resetting, whereas – for safety reasons due to possible high pressure in the compressor – the high pressure switch has manual resetting. The pressure switch calibration values are shown in the installation manual supplied with the machine.

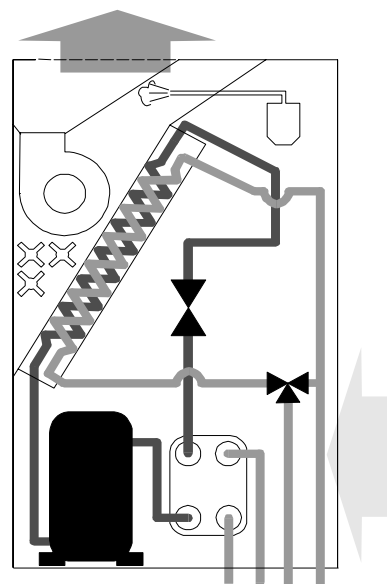

Condenser

The units are provided with a built–in stainless steel water condenser with braze–welded plates; this advanced exchanger type gives the highest efficiency in heat exchange. In addition, a certain oversizing of the exchanger has been provided so as to reduce pressure drops (and energy consumption of the water pump) as much as possible and thus to allow the unit to operate with the external chiller in closed circuit, even at high outdoor temperatures.

The units shall operate with **throwaway water**, **tower water** or **water in closed circuit** with external chiller. In the operation with closed circuit, the water is cooled by the outdoor air in a heat exchanger; in this case, to avoid unwished ice formation during winter, it is advisable to obtain the mixture always with a glycol percentage (refer to the installation manual for the suitable percentages). The circulation of the water–glycol mixture is forced (the pump is not supplied). If throwaway water or tower water is used, when installing the unit fit a **mechanical filter** on the water line to protect the condenser against possible impurities contained in the water (for the condenser cleaning see the installation manual).

Hydraulic circuit

The unit is provided with a **3–way modulating valve**, complete with incremental motor for the water flow control to the coil; the opening or closing signals, generated by the electronic control, adjust the valve in order to keep the ambient temperature at the required value. Through a series of menus it is possible to set all parameters on the control for a correct adjustment, i.e. set–points, proportional bands, proportional or proportional+integral adjustment, integrating factor and valve feature. It is possible to adjust the valve manually in closing position (coil side) by means of a suitable wrench.

Refrigerating circuit

The 8 models are provided with a **single refrigerating circuit**, the units 9 have two refrigerating circuits. The refrigerating circuit includes the compressor and the thermal expansion valve with an external equalizer controlling the refrigerant flow to the evaporator so as to keep a steady overheating degree. Before the thermal expansion valve there is a **sight glass** enabling the visual check of the refrigerant charge. A **dryer filter** is installed in the liquid line for better cleaning and less humidity in the circuit. **On-off valves** are installed as standard to help the extraordinary maintenance of the circuits. A suitably sized **safety valve** is installed after the condenser; the valve is equipped with flanged connections to allow the refrigerant to be discharged outside through suitable pipes. All low temperature parts of the refrigerating circuit are insulated. The refrigerating circuit is also provided with a high pressure switch and a low pressure switch. Il pressostato di minima è a riarmo automatico, mentre, per ragioni di sicurezza derivanti dalle possibili alte pressioni nel compressore, il pressostato di massima è dotato di riarmo manuale. I valori di taratura dei pressostati sono indicati nel manuale di installazione, fornito a bordo macchina.

The low pressure switch has automatic resetting, whereas – for safety reasons due to possible high pressure in the compressor – the high pressure switch has manual resetting. The pressure switch calibration values are shown in the installation manual supplied with the machine.

The low pressure switch has automatic resetting, whereas – for safety reasons due to possible high pressure in the compressor – the high pressure switch has manual resetting. The pressure switch calibration values are shown in the installation manual supplied with the machine.

Condenser

The units are provided with built-in stainless steel water condensers with braze-welded plates; this advanced exchanger type gives the highest efficiency in heat exchange. In addition, a certain oversizing of the exchanger has been provided so as to reduce pressure drops (and energy consumption of the water pump) as much as possible and thus to allow the unit to operate with the external chiller in closed circuit, even at high outdoor temperatures. The units shall operate with **water in closed circuit** with external chiller. In the operation with closed circuit, the water is cooled by the outdoor air in a heat exchanger; in this case, to avoid unwished ice formation during winter, it is advisable to obtain the mixture always with a glycol percentage (refer to the installation manual for the suitable percentages). The circulation of the water-glycol mixture is forced (the pump is not supplied). To minimize water consumption and the condensing pressure check during the different seasons of the year, the unit is provided with a water register supplied as standard on the machine.

Hydraulic circuit

The unit is provided with a **2-way modulating valve**, complete with incremental motor for the water flow control to the freecooling coil; the opening or closing signals, generated by the electronic control, manage the valve in order to keep the ambient temperature at the required value.

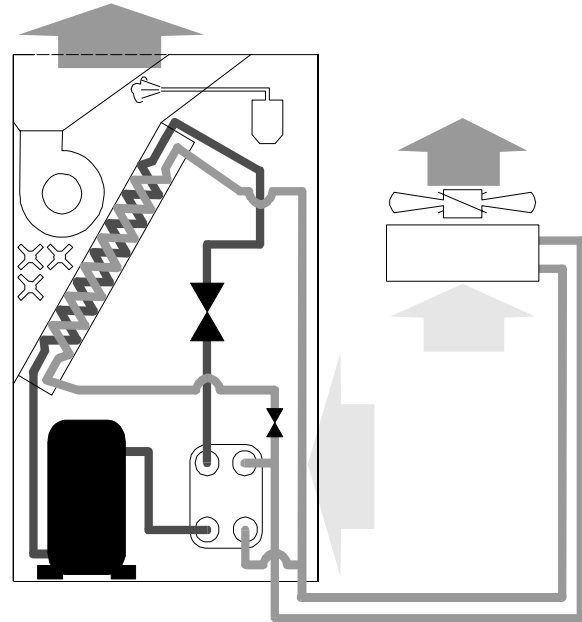

2.6 – Version C

Chilled water units

Hydraulic circuit

Each unit is provided with one hydraulic circuit. The unit is provided with a **3-way modulating valve**, complete with incremental motor for the water flow control to the coil; the opening or closing signals, generated by the electronic control, manage the valve in order to keep the ambient temperature at the required value.

Through a series of menus it is possible to set all parameters on the control for a correct adjustment, i.e. set-points, proportional bands, proportional or proportional+integral adjustment, integrating factor and valve feature. It is possible to adjust the valve manually in closing position (coil side) by means of a suitable wrench.

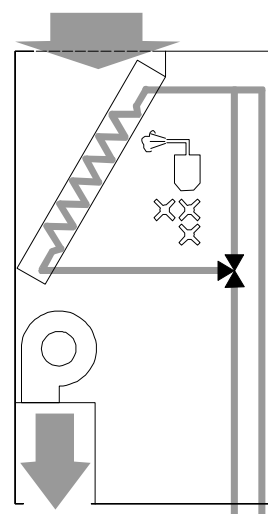

2.7 – Hiflex Constant versione A

Direct expansion air–condensed units with high precision control

Refrigerating circuit

Each unit is provided with a **single refrigerating circuit**. This is similar to the version's refrigerant circuit (see para. 2.1), but a modulating hot gas bypass valve is present. This valve permits high precision evaporating temperature regulation.

For other characteristics, see para. 2.1.

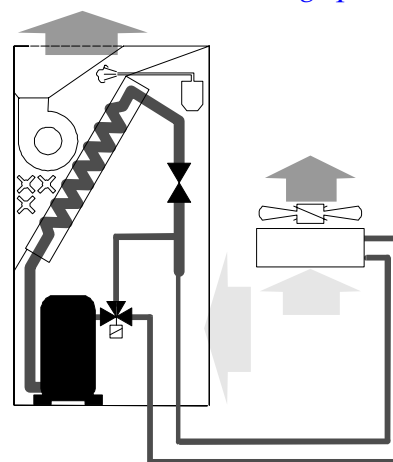

2.8 – Hiflex Constant versione W

Direct expansion water–condensed unit with high precision control

Refrigerating circuit

Each unit is provided with a **single refrigerating circuit**. This is similar to the version's refrigerant circuit (see para. 2.2), but a modulating hot gas bypass valve is present. This valve permits high precision evaporating temperature regulation.

For other characteristics, see para. 2.2.

Here is a summary list of the peculiar features of the different versions:

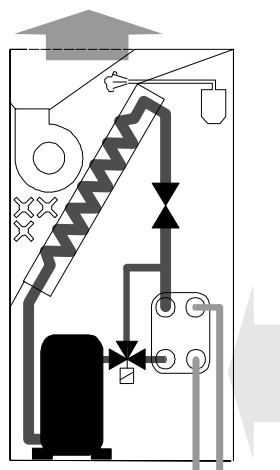

Here is a summary list of the peculiar features of the different versions:

	Heat exchange	Refrigerating circuit	Installation
A	The unit cools the air by an air/refrigerant coil (direct expansion). The refrigerating circuit condenser is externally mounted, air-cooled.	The refrigerating circuits are not pre-charged with refrigerant. There is a liquid receiver on which the safety valve is installed. The Constant units are equipped with hot gas by-pass valve.	The unit must be connected to the external condenser and the refrigerant must be charged.
W	The unit cools the air by an air/refrigerant coil (direct expansion). The refrigerating circuit plate condenser is indoor, cooled by a water flow.	The refrigerating circuits are pre-charged with refrigerant. The safety valve is installed downstream the condenser. The Constant units are equipped with hot gas by-pass valve.	The unit must be connected to the piping of the cooling water of the water/refrigerant condenser.
D	The dualfluid unit cools the air flow by means of an air/refrigerant coil (direct expansion) or, as an alternative, an air/water coil. The refrigerating circuit condenser is externally mounted, air-cooled.	The refrigerating circuits are not pre-charged with refrigerant. There is a liquid receiver on which the safety valve is installed.	It is necessary to connect the unit to the external condenser, to charge it with refrigerant and to connect the chilled water piping for the air/water coil.
H	The dualfluid unit cools the air flow by means of an air/refrigerant coil (direct expansion) or, as an alternative, an air/water coil. The refrigerating circuit plate condenser is indoor, cooled by a water flow.	The refrigerating circuits are pre-charged with refrigerant. The safety valve is installed downstream the condenser.	The unit must be connected to the chilled water piping for the air/water coil and to the cooling water piping of the water/refrigerant condenser.
F	The freecooler unit cools the air flow by means of an air/refrigerant coil (direct expansion) or, as an alternative, an air/water coil. The water flow is cooled by an external rad-cooler. When the external temperature is higher than the ZET, the water exchanges heat with the refrigerant in the internal water/refrigerant plate condenser. When the external temperature is lower than the ZET, the water is cooled as much as sufficiently to cool the air directly in the air/water coil.	The refrigerating circuits are pre-charged with refrigerant. The safety valve is installed downstream the condenser.	The unit must be connected to the closed water circuit with the rad-cooler.
C	The unit cools the air flow by an air/water coil.	The unit has no refrigerating circuit.	The unit must be connected to the chilled water piping.

2.9 – Air control

All units are available in the three configurations shown below. The **Hiflex Constant** units are supply with upward air flow (Over) only.

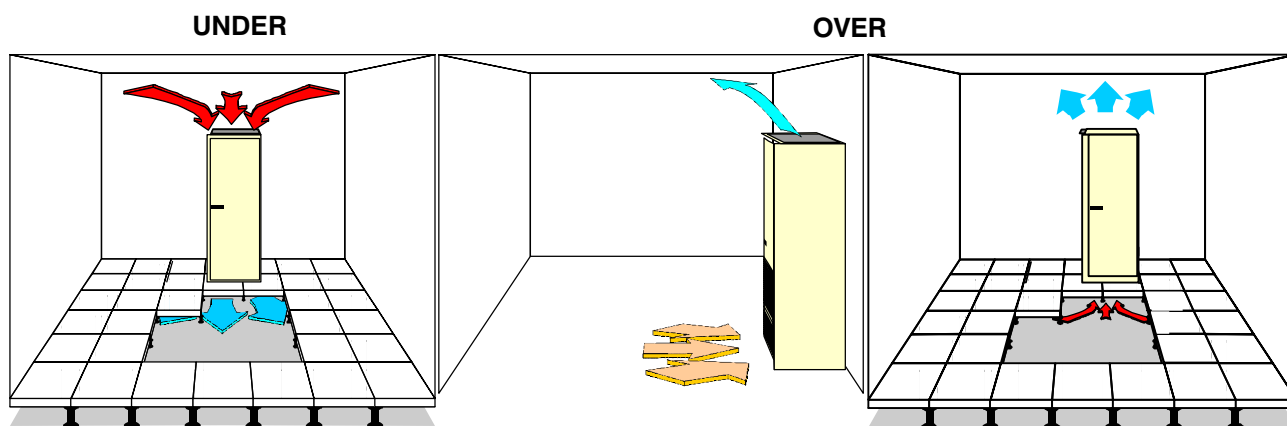

2.10 – Dimensions and accessibility

The unit structures are made in three sizes with the following dimensions:

	W	D	H
Size 4:	750	450	1950
Size 6:	750	600	1950
Size 8:	750	750	1950
Size 5:	1490	450	1950
Size 7:	1490	600	1950
Size 9:	1490	750	1950

Ordinary and special maintenance is easier thanks to the front access enabling the replacement of the air filters, the intervention on the components of the refrigerating circuit – such as compressor, liquid receiver, thermal expansion valve, refrigerant sight glass, drying filter – or on the fan, the humidifier, the electric board, the electronic control, the electric heating elements.

The refrigerant, electric and hydraulic connections are placed on the lower part of the unit.

3 – Operating limits

All versions

HIFLEX units are provided for operating within the following working ranges (the limits concern new units on which correct installation and maintenance have already been made):

Ambient conditions:

from 18.0°C, 45% R.H. to 27.0°C, 55% R.H.

To avoid the formation of too much condensate which might cause water drops entrainment, it is important to check that the latent capacity – difference between total and sensible load at the selected conditions doesn't exceed the value of 5.5 kW.

Air flow

The minimum and maximum values are shown in the tables of the useful available heads. However, safety devices are provided as standard to protect the various components from any damages due to operation outside the indicated limits.

Power tolerances

Standard voltage (V): $\pm 10\%$

Standard frequency (Hz): ± 2

Versions A and D

Outdoor conditions:

low limit = +10°C (from +9°C to –20°C with Variex accessory installed on the condenser)

high limit determined by the size of the coupled condenser. Exceeding these limits causes the compressor lock due to the safety pressure switch, which can be restored only by hand.

Condensing unit installation:

Maximum distance between ambient unit and external air condenser: 30 m (equivalent length).

Max. geodetic height difference between condenser and unit: 3 m (if the condenser is placed underneath the ambient unit).

Attenzione:

I ventilatori centrifughi dispongono di prevalenza pari a quella nominale di progetto. Se le perdite di carico del condotto di espulsione sono esigue (condotto molto corto o sovradimensionato) la corrente assorbita dal motore può superare il valore di targa del motore. In questi casi è assolutamente necessario attenersi ad una delle seguenti istruzioni:

- 1) Introdurre nel circuito delle perdite di carico supplementari (inserendo nel condotto una serranda manuale o una tagliola).
- 2) Ridurre il numero di giri del ventilatore ovunque sia possibile, ossia quando il ventilatore è accoppiato mediante cinghie al motore oppure quando è dotato di motore monofase a più velocità.

N.B.: L'operazione può considerarsi definitiva quando l'assorbimento del ventilatore sarà prudenzialmente inferiore al valore di targa di almeno il 10%.

4 – Component features

4.1 – Fan

Double section, galvanized steel, centrifugal fan, forward blades.

High efficiency.

The motor is single–phase; provided with internal thermal protection.

The fan wheel is statically and dynamically balanced; the bearings are self–lubricating.

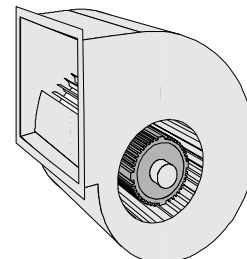

4.2 – Compressor

SCROLL compressors

High COP (Coefficient Of Performance)

High MTBF (Minimum Time Between Failures)

Low sound level.

Vibration–damped.

Provided with internal thermal protection.

Low pickup current (equalization of the internal pressures).



4.3 – Coils

High front surface.

Made of copper pipes and aluminium fins.

Fins treated with hydrofile styrol acrylic paints to withstand corrosive atmospheres.

Low pressure drop.

High SHR (Sensible Heat Ratio).

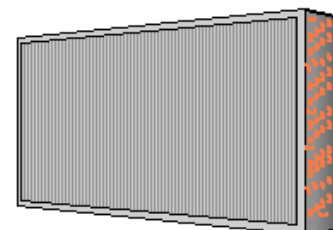

4.4 – Frame and panels

The sheet steel structure, painted with RAL 7035 epoxy–polyester powders, is assembled by stainless steel screws; the paneling system ensures higher stiffness; there will also be some pluggings (compressor space and fan) for guaranteeing both safety and high acoustic absorption.

The electric board protecting panel is assembled on hinges to make the access easier; this can be opened by the fast closing lock. The side panels are screwed to the supports. The rear panel is screwed directly to the frame.

The air returns from the machine top in machines with underfloor air delivery, whereas in machines with upward air delivery it returns through the metal grid on the front panel.

The compressor is housed in a closed space in the lower part of the unit and is completely insulated against the air flow. The compressor section can be reached even during the unit operation by removing the front panel and the protection plugging.

The panels are lined with thermoacoustic insulating material – class 1.

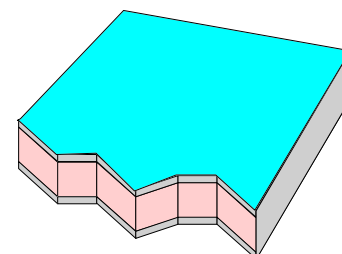

4.5 – Filters

Removable filters.

The guaranteed efficiency degree is from G3 and F9 (CEN EN 779, corresponding to EU3 and EU9 according to Eurovent EU4/5).

The folded structure of the filters gives high filtration efficiency and low pressure drop.

The filter media used consists of synthetic fibre cells. The frame is made of cardboard.

Pre-filtration system for Over models.

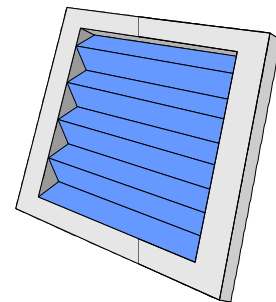

4.6 – Refrigerants

The units are designed for being used with refrigerant R22 or, as optional, R407C.

4.7 – Electric board

The electric board is housed in the front part in a space insulated against the air flow and protected by a plastic crankcase, so as to avoid tampering by non-authorized personnel and to protect the electric board parts supplied with a voltage higher than 24 V.

The electric board complies with the norm 204-1 IEC.

The air conditioners have been provided for operating at 400 V~/3/50 Hz+N+G (as special alternative execution, the version with 220~/3/50Hz + G can be supplied) and at 380 V~/3/60 Hz+N+G and 230~/3/60 Hz+G.

Magnetothermal switches are supplied as protection of every electric component.

A single-phase transformer has been provided for supplying power to the secondary circuit at 24 V.

A main switch with door-locking handle is installed in series on the safety crankcase to prevent it from being removed when the switch is in the operating position.

There will be an automatic start-up after a possible stop due to power supply lack.

Additional terminals for remote start-up and carry of some operating conditions (fans and compressors) or connection of additional devices (Liquistat, Firestat, Smokestat, clogged filters) are set in series on the terminal board of the electric board. On the terminal board there is also a clean contact for the remote signalling of the general alarm.



4.8 – Accessibility

Having access to the compressor is possible even when the unit is operating by removing the front panel. The access to the fan is executed with the greatest care for easier interventions (maintenance and/or fan replacement).



4.9 – Control system

Very simple user interface.

Immediately intelligible utilization of the control unit system with LCD.

Net connectivity of several units.

Possible utilization of the Hiromatic graphic terminal.

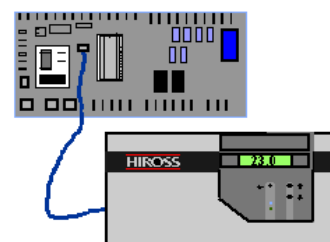

4.10 – Packing

The air conditioners are usually packed in wooden pallets and carton boxes. An air bubble plastic film protects the painted surfaces.

On request, wooden crates or cases can be supplied for the sea transport.

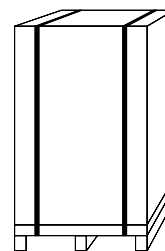

4.11 – Product quality and safety

The product conforms to European Union directives 98/37/CE (89/392/CEE; 91/368/CEE; 93/68/CEE), 89/336/CEE; 73/23/CEE; 97/23/EC.

Further, the Company Quality System of Air Conditioning Division is approved by LRQA according to the standards UNI EN ISO 9001: 2000 and the product is the result of activities performed in compliance with the provisions contained in the Quality procedures and plans.

Il Sistema Garanzia Qualità della Divisione Air Conditioning è certificato da Lloyd's Register Quality Assurance conforme alla norma ISO 9001:1994.



The unit is supplied complete with a test certificate and conformity declaration and control component list.

The units of the Hiflex series are marked as they comply with the European directives concerning mechanical, electrical, electromagnetic and pressure equipment safety.

5 – Condensing section

5.1 – Air condensers

The units may be connected to a wide range of our condensers single circuit (HCA) or double circuit (HBA).

The following paragraphs describe the suggested coupling for **Hiflex** units as a function of the outdoor air temperature. The data given below are approximate and must always be verified on the basis of the specific performances and different operating conditions.



Standard Model	Performances			Electric data			Overall dimensions		
	Duty ^(d)	Air flow	SPL 5 m	Supply	Number of fans	Total absorbed power	Width	Depth	Height ^(e)
	kW	m ³ /h	dB(A)	V/ph/Hz	n ^o	kW	mm	mm	mm
HCA07	7.1	1900	44	230/1/50 ^(a)	1	0.18	803	451	703
HCA10	9.4	4100	47	230/1/50 ^(a)	2	0.36	1253	451	703
HCA14	14.5	4430	44	230/1/50 ^(a)	1	0.29	1175	797	890
HCA17	16.5	4160	44	230/1/50 ^(a)	1	0.29	1175	797	890
HCA24	24.0	7950	51	230/1/50 ^(b)	1	0.52	1325	1098	992
HCA29	28.3	7530	51	230/1/50 ^(b)	1	0.52	1325	1098	992
HCA33	32.1	8320	47	230/1/50 ^(a)	2	0.58	2125	797	890
HBA33	32.1	8320	47	230/1/50 ^(a)	2	0.58	2125	797	890
HCA42	41.6	15900	54	230/1/50 ^(b)	2	1.04	2425	1098	992
HCA49	47.9	15900	54	230/1/50 ^(b)	2	1.04	2425	1098	992
HBA49	47.9	15900	54	230/1/50 ^(b)	2	1.04	2425	1098	992
HCA58	56.6	15060	54	230/1/50 ^(b)	2	1.04	2425	1098	992
HCA74	72	23850	57	230/1/50 ^(b)	3	1.56	3526	1098	992
HBA74	72	23850	57	230/1/50 ^(b)	3	1.56	3526	1098	992
HCA87	84.9	22590	57	230/1/50 ^(b)	3	1.56	3526	1098	992
HBA87	84.9	22590	57	230/1/50 ^(b)	3	1.56	3526	1098	992
HCA95	91.5	21750	57	230/1/50 ^(b)	3	1.56	3526	1098	992
HBA99	113	30120	58	230/1/50 ^(b)	4	2.08	4625	1098	992

Low noise Model	Performances			Electric data			Overall dimensions		
	Duty (d)	Air flow	SPL 5 m	Supply	Number of fans	Total absorbed power	Width	Depth	Height (c)
	kW	m ³ /h	db(A)	V/ph/Hz	n°	kW	mm	mm	mm
HCA07	5.0	1230	38	230/1/50 ^(a)	1	0.16	803	451	703
HCA10	7.2	2750	41	230/1/50 ^(a)	2	0.32	1253	451	703
HCA14	11.1	3230	40	230/1/50 ^(a)	1	0.20	1175	797	890
HCA17	12.7	2920	40	230/1/50 ^(a)	1	0.20	1175	797	890
HCA24	20.4	6260	45	230/1/50 ^(b)	1	0.37	1325	1098	992
HCA29	23.6	5950	45	230/1/50 ^(b)	1	0.37	1325	1098	992
HCA33	25	5840	43	230/1/50 ^(a)	2	0.39	2125	797	890
HBA33	25	5840	43	230/1/50 ^(a)	2	0.39	2125	797	890
HCA42	36.4	12520	48	230/1/50 ^(b)	2	0.74	2425	1098	992
HCA49	40.8	12520	48	230/1/50 ^(b)	2	0.74	2425	1098	992
HBA49	40.8	12520	48	230/1/50 ^(b)	2	0.74	2425	1098	992
HCA58	47.2	11900	48	230/1/50 ^(b)	2	0.74	2425	1098	992
HCA74	61.2	18780	51	230/1/50 ^(b)	3	1.11	3526	1098	992
HBA74	61.2	18780	51	230/1/50 ^(b)	3	1.11	3526	1098	992
HCA87	70.8	17850	51	230/1/50 ^(b)	3	1.11	3526	1098	992
HBA87	70.8	17850	51	230/1/50 ^(b)	3	1.11	3526	1098	992
HCA95	73.5	16710	51	230/1/50 ^(b)	3	1.11	3526	1098	992
HBA99	95	25380	51	230/1/50 ^(b)	4	1.63	4625	1098	992

(a): available with 230V/1ph/60Hz.

(b): available with 400V/3ph/60Hz

(c): vertical flow installation.

(d): at the following conditions: dT (condensing temp – outdoor temp) = 15 °C; outdoor temperature 35 °C; 0 m a.s.l.

Coupling of remote air condensers

Coupling of Condensers for HIFLEX single circuit

Model	External temperature up to 30°C		External temperature up to 35°C		External temperature up to 40°C		External temperature up to 46°C	
	Standard	Low noise	Standard	Low noise	Standard	Low noise	Standard	Low noise
4M U/O A	HCA 07	HCA 07	HCA 07	HCA 07	HCA 07	HCA 10	HCA 14	HCA 14
4S/P U/O A	HCA 07	HCA 07	HCA 07	HCA 07	HCA 07	HCA 10	HCA 14	HCA 14
4L/G U/O A	HCA 07	HCA 10	HCA 10	HCA 10	HCA 10	HCA 14	HCA 14	HCA 14
6S/P U/O A	HCA 10	HCA 10	HCA 10	HCA 14	HCA 14	HCA 14	HCA 14	HCA 14
6L/G U/O A	HCA 10	HCA 14	HCA 14	HCA 14	HCA 14	HCA 24	HCA 24	HCA 24
8S/P U/O A	HCA 14	HCA 14	HCA 14	HCA 17	HCA 17	HCA 24	HCA 24	HCA 29
8L/G U/O A/D	HCA 14	HCA 14	HCA 14	HCA 24	HCA 24	HCA 24	HCA 29	HCA 42

Coupling of Condensers for HIFLEX double circuit

Model	External temperature up to 30°C		External temperature up to 35°C		External temperature up to 40°C		External temperature up to 46°C	
	Standard	Low noise	Standard	Low noise	Standard	Low noise	Standard	Low noise
5S/P U/O A	2 x HCA07	2 x HCA07	2 x HCA07	2 x HCA07	2 x HCA07	2 x HCA10	2 x HCA14	2 x HCA14
5L/G U/O A	2 x HCA07	2 x HCA10	2 x HCA10	2 x HCA10	2 x HCA10	2 x HCA14	2 x HCA14	2 x HCA24 or 1 x HBA49
7S/P U/O A	2 x HCA10	2 x HCA10	2 x HCA10	2 x HCA14	2 x HCA14	2 x HCA17 or 1 x HBA33	2 x HCA24 or 1 x HBA49	2 x HCA24 or 1 x HBA49
7L/G U/O A	2 x HCA10	2 x HCA14	2 x HCA14	2 x HCA14	2 x HCA14	2 x HCA24 or 1 x HBA49	2 x HCA24 or 1 x HBA49	2 x HCA24 or 1 x HBA49
9S/P U/O A	2 x HCA14	2 x HCA14	2 x HCA14	2 x HCA17 or 1 x HBA33	2 x HCA17 or 1 x HBA33	2 x HCA24 or 1 x HBA49	2 x HCA24 or 1 x HBA49	2 x HCA29
9L/G U/O A/D	2 x HCA14	2 x HCA14	2 x HCA14	2 x HCA24 or 1 x HBA49	2 x HCA24 or 1 x HBA49	2 x HCA24 or 1 x HBA49	2 x HCA29	2 x HCA42 or 1 x HBA87

Coupling of Condensers for HIFLEX constant

Model	External temperature up to 30°C		External temperature up to 35°C		External temperature up to 40°C		External temperature up to 46°C	
	Standard	Low noise	Standard	Low noise	Standard	Low noise	Standard	Low noise
4S/P CA	HCA 07	HCA 07	HCA 07	HCA 07	HCA 07	HCA 10	HCA 10	HCA 14
4L/G CA	HCA 07	HCA 07	HCA 07	HCA 10	HCA 10	HCA 14	HCA 14	HCA 24
6S/P CA	HCA 10	HCA 10	HCA 10	HCA 14	HCA 14	HCA 14	HCA 24	HCA 24
8S/P CA	HCA 14	HCA 14	HCA 14	HCA 14	HCA 14	HCA 24	HCA 24	HCA 29

The coupling applies for a total equivalent distance of max. 30 m and in compliance with the instructions for the unit installation. Max. geodetic height difference between condenser and unit: 3 m (if the condenser is placed underneath the ambient unit).

5.2 – Water condensers.

The water–condensed units are provided with a water/refrigerant exchanger with braze–welded **plates** made of **stainless steel**; this advanced exchanger type gives the highest efficiency in heat exchange. In addition, a certain oversizing of the exchanger has been provided so as to reduce pressure drops (and energy consumption of the water pump) as much as possible and thus to allow the unit to operate with the external chiller in closed circuit, even at high outdoor temperatures.

The O/UW units are designed for operating with mains water, tower water or water in closed circuit with an external chiller. When operating in a closed circuit, the water is cooled by the outdoor air in a heat exchanger; in this case, to avoid unwanted ice formation during winter, it is advisable to use a water/glycol mixture. The circulation of the water–glycol mixture is forced (the pump is not supplied). If mains water or tower water is used, when installing the unit fit a mechanical filter on the water line to protect the condenser against possible impurities contained in the water (for condenser cleaning see the installation manual).

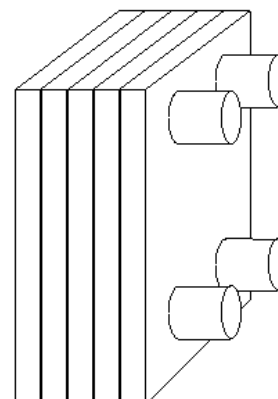

5.3 – Dry coolers

Our dry–coolers are built with a copper/aluminium cooling coil and axial fan(s). The main data on dry coolers is shown in the following table:

Standard Model	Performances			Electric data			Overall dimensions		
	Duty (a)	Air flow	SPL 10 m	Supply	Number of fans	Total absorbed power	Width	Depth	Height (b)
	kW	m ³ /h	db(A)	V/ph/Hz	n°	kW	mm	mm	mm
DSM009	9	6.600	50	230/1/50	1	0.64	1.250	900	990
DSM013	13.5	5.100	50	230/1/50	1	0.64	1.250	900	990
DSM018	17.6	13.200	53	230/1/50	2	1.28	2.050	900	990
DSM022	22.4	12.600	53	230/1/50	2	1.28	2.050	900	990
DSM028	27.5	18.900	54	230/1/50	3	1.92	2.850	1.260	990
DST030	33	20.500	55	400/3/50	2	1.44	2.750	1.260	1.140
DST040	39	20.000	55	400/3/50	2	1.44	2.730	1.260	1.140
DST050	50	30.750	57	400/3/50	3	2.16	3.900	1.260	1.140
DST060	58	30.000	57	400/3/50	3	2.16	3.900	1.260	1.140
DST070	68	28.350	57	400/3/50	3	2.16	3.900	1.260	1.140
DST080	80	40.000	58	400/3/50	4	2.88	5.060	1.260	1.140
DST110	108	52.500	59	400/3/50	3	4.35	5.010	1.640	1.500
DST135	134	70.000	60	400/3/50	4	5.8	6.520	1.640	1.500
DST175	175	110.000	64	400/3/50	4	12.8	6.520	1.640	1.570
DST220	220	106.000	64	400/3/50	4	12.8	6.520	1.640	1.570
DST270	270	132.500	65	400/3/50	5	16	8.055	1.640	1.570
DST290	284	204.000	67	400/3/50	8	25.6	6.155	2.420	1.570
DST330	326	208.000	63	400/3/50	8	17.6	7.355	2.440	1.770
DST360	362	255.000	68	400/3/50	10	32	7.555	2.420	1.770
DST400	400	190.000	63	400/3/50	8	17.6	7.355	2.440	1.770
DST450	447	235.000	68	400/3/50	10	2	7.555	2.420	1.570
DST500	500	237.500	64	400/3/50	10	32	9.055	2.440	1.770

Low Noise Model	Performances			Electric data			Overall dimensions		
	Duty ^(a)	Air flow	SPL 10 m (c)	Supply	Number of fans	Total absorbed power	Width	Depth	Height ^(b)
	kW	m ³ /h	db(A)	V/ph/Hz	n°	kW	mm	mm	mm
DLM008	7.5	4.700	39	230/1/50	1	0.29	1250	900	990
DLM011	10.5	3.700	39	230/1/50	1	0.29	1250	900	990
DLM015	15.5	9.500	42	230/1/50	2	0.58	2.050	900	990
DLM018	18	9.000	42	230/1/50	2	0.58	2.050	900	990
DLM023	23	14.000	43	230/1/50	3	0.87	2.850	1260	990
DLT027	27.5	15.000	47	400/3/50	2	0.7	2.750	1260	1.140
DLT030	30	14.500	47	400/3/50	2	0.7	2.730	1260	1.140
DLT040	40	22.500	49	400/3/50	3	1.05	3.900	1260	1.140
DLT047	47	21.750	49	400/3/50	3	1.05	3.900	1260	1.140
DLT055	54	20.250	49	400/3/50	3	1.05	3.900	1260	1.140
DLT065	65	29.000	50	400/3/50	4	1.4	5.060	1260	1.140
DLT085	84	40.500	54	400/3/50	3	2.16	5.010	1.640	1.500
DLT110	112	54.000	55	400/3/50	4	2.88	6.520	1.640	1.500
DLT130	130	67.000	51	400/3/50	4	3.72	6.520	1.640	1.570
DLT160	157	62.000	51	400/3/50	4	3.72	6.520	1.640	1.570
DLT190	190	77.500	52	400/3/50	5	4.65	8.055	1.640	1.570
DLT210	212	123.000	54	400/3/50	8	7.44	6.155	2.420	1.570
DLT250	253	132.000	51	400/3/50	8	6.88	7.355	2.440	1.770
DLT270	270	153.750	55	400/3/50	10	9.3	7.555	2.420	1.770
DLT290	290	118.000	51	400/3/50	8	6.88	7.355	2.440	1.770
DLT310	310	137.500	55	400/3/50	10	9.3	7.555	2.420	1.570
DLT350	350	147.500	52	400/3/50	10	8.6	9.055	2.440	1.770

(a): at the following conditions: outdoor temperature = 35 °C, inlet/outlet water temperature = 45 °C/40 °C.

(b): vertical flow installation.

(c): according to DIN45635.

Coupling of Dry-coolers

Coupling of Dry Coolers for HIFLEX single circuit

Model	External temperature up to 30°C		External temperature up to 35°C		External temperature up to 40°C	
	Standard	Low noise	Standard	Low noise	Standard	Low noise
4S/P U/O W	DSM009	DLM008	DSM009	DLM008	DSM013	DLM011
4L/G U/O W	DSM009	DLM008	DSM009	DLM008	DSM013	DLM011
6S/P U/O W	DSM009	DLM008	DSM009	DLM008	DSM018	DLM015
6L/G U/O W	DSM009	DLM011	DSM013	DLM011	DSM018	DLM015
8S/P U/O W	DSM013	DLM011	DSM013	DLM011	DSM018	DLM015
8L/G U/O W/F/H	DSM013	DLM011	DSM013	DLM015	DSM022	DLM018

Coupling of Dry Coolers for HIFLEX double circuit

Model	External temperature up to 30°C		External temperature up to 35°C		External temperature up to 40°C	
	Standard	Low noise	Standard	Low noise	Standard	Low noise
5S/P U/O W	DSM009	DLM008	DSM013	DLM011	DSM018	DLM015
5L/G U/O W	DSM013	DLM011	DSM013	DLM015	DSM028	DLM018
7S/P U/O W	DSM013	DLM015	DSM018	DLM015	DSM028	DLM018
7L/G U/O W	DSM018	DLM015	DSM018	DLM015	DST030	DLM023
9S/P U/O W	DSM018	DLM015	DSM022	DLM018	DST040	DLT027
9L/G U/O W/F/H	DSM022	DLM018	DSM028	DLM023	DST050	DLT040

Coupling of Dry Coolers for HIFLEX constant

Model	External temperature up to 30°C		External temperature up to 35°C		External temperature up to 40°C	
	Standard	Low noise	Standard	Low noise	Standard	Low noise
4S/P CW	DSM009	DLM008	DSM009	DLM008	DSM013	DLM011
4L/G CW	DSM009	DLM008	DSM009	DLM008	DSM013	DLM011
6S/P CW	DSM009	DLM008	DSM009	DLM008	DSM018	DLM015
8S/P CW	DSM013	DLM011	DSM013	DLM011	DSM018	DLM015

6 – Technical remarks

6.1 – Fluid, R407C

Recent international agreements (Montreal, London, Copenhagen, Vienna and San José) have abolished – with precise expiry dates – the production of the HCFC fluids (e.g.: R22) considered as harmful for the ozone layer. The new HFC fluids (hydrofluorocarbons) which have to replace them contain no chlorine, a dangerous substance for the ozone layer. The refrigerant R407C replace the fluid R22.

Its main features are:

- ✓ Non-azeotropic mixture made of R32/R125/R134a in which the percentage weight composition is, in ratio, 23/25/52.
- ✓ Thermophysical features similar to R22.
- ✓ ODP (Ozone Depletion Potential) equal to 0.
- ✓ Not flammable in the air.
- ✓ Low toxicity degree.

The new HFC fluids are essentially incompatible with the mineral oils which are usually used with the fluids R12 and R22.

Therefore, new synthetic lubricants based on polyester molecules have been developed for their use.

Note: considering the peculiar thermophysical features of the fluid we give the description of the refrigerating cycle shown in the phase diagram of the R407C.

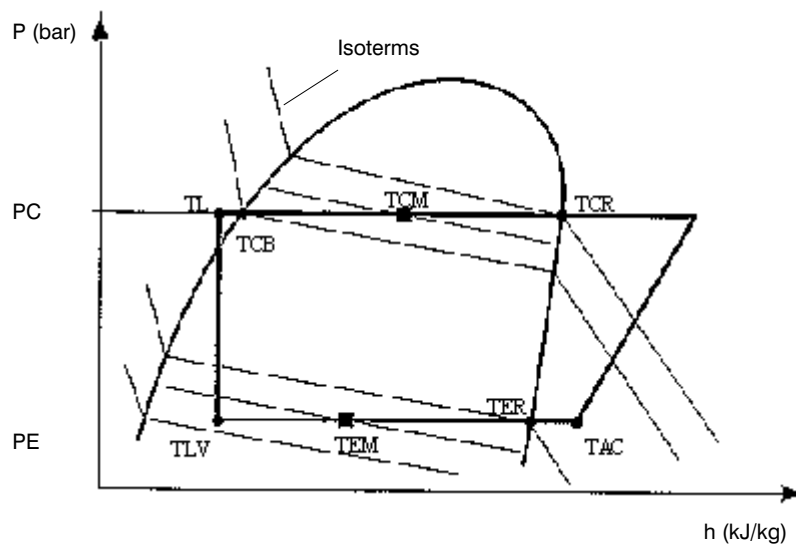

High pressure side

TCB: condensation temperature bubble point (Liquid)

TCR: condensation temperature dew point (Vapor)

TCM: average condensation temperature $(TCB+TCM)/2$

TL: temperature of the refrigerant at the expansion valve inlet

Overheating = $TAC - TER$

Low pressure side

TLV: liquid-steam temperature

TER: evaporation temperature dew point (Vapor)

TEM: average evaporation temperature $(TLV+TER)/2$

TAC: temperature of the refrigerant at the compressor inlet

Sub-cooling = $TCB - TL$

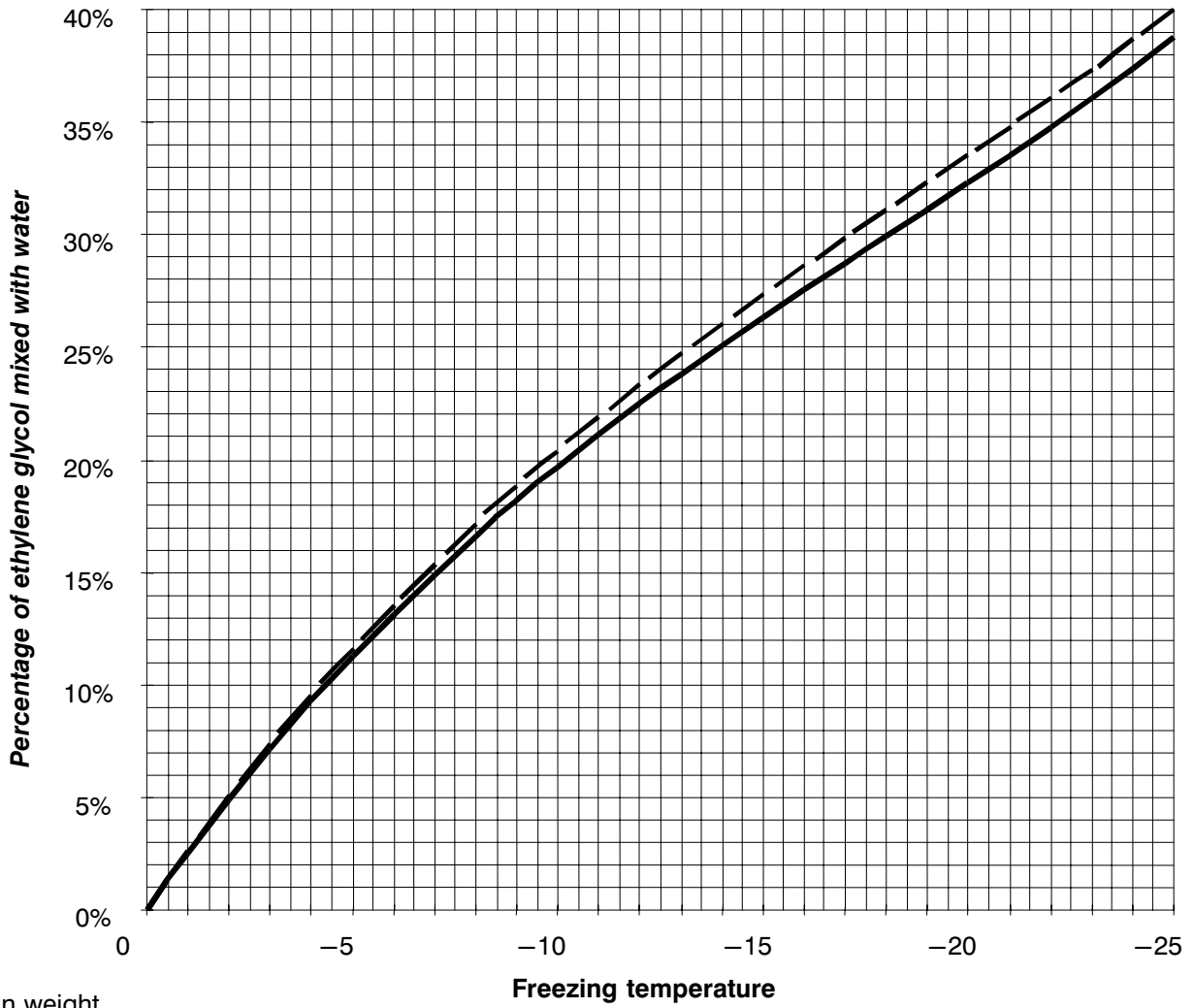

% in weight

% in volume

7 – Electrical characteristics

50 Hz / R 22

Model	STANDARD POWER SUPPLY								OPTIONAL POWER SUPPLY							
	FAN 1ph – 230V				COMPRESSOR 3ph – 400V				FAN 1ph – 230V				COMPRESSOR 3ph – 230V			
	OA	FLA	LRA	operating power (kW)	OA	FLA	LRA	operating power (kW)	OA	FLA	LRA	operating power (kW)	OA	FLA	LRA	operating power (kW)
STANDARD R 22																
4MUA (*)	1.2	1.6	2.9	0.3	6.0	8.7	36.5	1.4	1.2	1.6	2.9	0.3	6.0	8.7	36.5	1.4
4SUA/W (*)	1.4	2.1	3.1	0.3	6.5	10.9	45.0	1.4	1.4	2.1	3.1	0.3	6.5	10.9	45.0	1.4
4LUA/W	2.6	3.8	4.4	0.6	3.8	5.5	38.5	2.0	2.6	3.8	4.4	0.6	6.6	10.9	80.9	2.0
6SUA/W	2.6	4.5	8.0	0.4	4.5	6.3	43.5	2.5	2.6	6.5	5.5	0.4	7.8	12.4	91.4	2.5
6LUA/W	3.3	4.5	8.0	0.5	5.9	7.5	51.0	2.9	3.3	6.5	5.5	0.5	10.2	14.8	108.0	2.9
8SUA/W	4.5	6.8	11.0	0.9	5.9	7.5	51.0	2.9	4.5	6.8	11.0	0.9	10.2	14.8	108.0	2.9
8LUA/W	5.4	6.8	11.0	1.2	7.4	9.6	59.5	3.6	5.4	6.8	11.0	1.2	12.8	19.1	136.0	3.6
5SUA/W (*)	1.4 x 2	2.1 x 2	3.1 x 2	0.6	6.5 x 2	10.9 x 2	45.0 x 2	2.8	1.4 x 2	2.1 x 2	3.1 x 2	0.6	6.5 x 2	10.9 x 2	45.0 x 2	2.8
5LUA/W	2.6 x 2	3.8 x 2	4.4 x 2	1.21	3.8 x 2	5.5 x 2	38.5 x 2	4.0	2.6 x 2	3.8 x 2	4.4 x 2	1.2	6.6 x 2	10.9 x 2	80.9 x 2	4.0
7SUA/W	2.6 x 2	4.5 x 2	8.0 x 2	0.8	4.5 x 2	6.3 x 2	43.5 x 2	5.0	2.6 x 2	6.5 x 2	5.5 x 2	0.8	7.8 x 2	12.4 x 2	91.4 x 2	5.0
7LUA/W	3.3 x 2	4.5 x 2	8.0 x 2	1.0	5.9 x 2	7.5 x 2	51.0 x 2	5.8	3.3 x 2	6.5 x 2	5.5 x 2	1.0	10.2 x 2	14.8 x 2	108.0 x 2	5.8
9SUA/W	4.5 x 2	6.8 x 2	11.0 x 2	1.8	5.9 x 2	7.5 x 2	51.0 x 2	5.8	4.5 x 2	6.8 x 2	11.0 x 2	1.8	10.2 x 2	14.8 x 2	108.0 x 2	5.8
9LUA/W	5.4 x 2	6.8 x 2	11.0 x 2	2.4	7.4 x 2	9.6 x 2	59.5 x 2	7.2	5.4 x 2	6.8 x 2	11.0 x 2	2.4	12.8 x 2	19.1 x 2	136.0 x 2	7.2
4MOA (*)	0.9	1.6	2.9	0.2	6.0	8.7	36.5	1.4	0.9	1.6	2.9	0.2	6.0	8.7	36.5	1.4
4SOA/W (*)	1.2	2.1	3.1	0.3	6.5	10.9	45.0	1.4	1.2	2.1	3.1	0.3	6.5	10.9	45.0	1.4
4LOA/W	2.5	3.8	4.4	0.5	3.8	5.5	38.5	2.0	2.5	3.8	4.4	0.5	6.6	10.9	80.9	2.0
6SOA/W	2.2	4.5	8.0	0.3	4.5	6.3	43.5	2.5	2.2	4.5	8.0	0.3	7.8	12.4	91.4	2.5
6LOA/W	3.1	4.5	8.0	0.5	5.9	7.5	51.0	2.9	3.1	4.5	8.0	0.5	10.2	14.8	108.0	2.9
8SOA/W	3.9	6.8	11.0	0.8	5.9	7.5	51.0	2.9	3.9	6.8	11.0	0.8	10.2	14.8	108.0	2.9
8LOA/W	4.7	6.8	11.0	1.1	7.4	9.6	59.5	3.6	4.7	6.8	11.0	1.1	12.8	19.1	136.0	3.6
4SCA/W (*)	1.4	2.1	3.1	0.3	6.5	10.9	45.0	1.4	1.4	2.1	3.1	0.3	6.5	10.9	45.0	1.4
4LCA/W	2.4	3.8	4.4	0.6	3.8	5.5	38.5	2.1	2.4	3.8	4.4	0.6	6.6	10.9	80.9	2.1
6SCA/W	2.2	4.5	8.0	0.4	4.5	6.3	43.5	2.5	2.2	4.5	8.0	0.4	7.8	12.4	91.4	2.5
8SCA/W	4.2	6.8	11.0	0.8	5.9	7.5	51.0	2.9	4.2	6.5	11.0	0.8	10.2	14.8	108.0	2.9
5SOA/W (*)	1.2 x 2	2.1 x 2	3.1 x 2	0.6	6.5 x 2	10.9 x 2	45.0 x 2	2.8	1.2 x 2	2.1 x 2	3.1 x 2	0.6	6.5 x 2	10.9 x 2	45.0 x 2	2.8
5LOA/W	2.5 x 2	3.8 x 2	4.4 x 2	1.0	3.8 x 2	5.5 x 2	38.5 x 2	4.0	2.5 x 2	3.8 x 2	4.4 x 2	1.0	6.6 x 2	10.9 x 2	80.9 x 2	4.0
7SOA/W	2.2 x 2	4.5 x 2	8.0 x 2	0.6	4.5 x 2	6.3 x 2	43.5 x 2	5.0	2.2 x 2	4.5 x 2	8.0 x 2	0.6	7.8 x 2	12.4 x 2	91.4 x 2	5.0
7LOA/W	3.1 x 2	4.5 x 2	8.0 x 2	1.0	5.9 x 2	7.5 x 2	51.0 x 2	5.8	3.1 x 2	4.5 x 2	8.0 x 2	1.0	10.2 x 2	14.8 x 2	108.0 x 2	5.8
9SOA/W	3.9 x 2	6.8 x 2	11.0 x 2	1.6	5.9 x 2	7.5 x 2	51.0 x 2	5.8	3.9 x 2	6.8 x 2	11.0 x 2	1.6	10.2 x 2	14.8 x 2	108.0 x 2	5.8
9LOA/W	4.7 x 2	6.8 x 2	11.0 x 2	2.2	7.4 x 2	9.6 x 2	59.5 x 2	7.2	4.7 x 2	6.8 x 2	11.0 x 2	2.2	12.8 x 2	19.1 x 2	136.0 x 2	7.2
4LUC	2.6	3.8	4.4	0.6					2.6	3.8	4.4	0.6				
6LUC	3.3	4.5	8.0	0.5					3.3	4.5	8.0	0.5				
8LUC	5.4	6.8	11.0	1.2					5.4	6.5	11.0	1.2				
4LOC	2.5	3.8	4.4	0.5					2.5	3.8	4.4	0.5				
6LOC	3.1	4.5	8.0	0.5					3.1	4.5	8.0	0.5				
8LOC	4.7	6.8	11.0	1.1					4.7	6.5	11.0	1.1				
8LUD/H	5.0	6.8	11.0	1.1	7.3	9.6	59.5	3.6	5.0	6.5	11.0	1.1	12.6	19.1	136.0	3.6
8LOD/H	4.5	6.8	11.0	1.0	7.3	9.6	59.5	3.6	4.5	6.5	11.0	1.0	12.6	19.1	136.0	3.6
8LUF	5.0	6.8	11.0	1.1	8.1	9.6	59.5	4.4	5.0	6.5	11.0	1.1	14.0	19.1	136.0	4.4
8LOF	4.5	6.8	11.0	1.0	8.0	9.6	59.5	4.4	4.5	6.5	11.0	1.0	13.9	19.1	136.0	4.4
9LUD/H	5.0 x 2	6.8 x 2	11.0 x 2	2.2	7.3 x 2	9.6 x 2	59.5 x 2	7.2	5.0 x 2	6.5 x 2	11.0 x 2	2.2	12.6 x 2	19.1 x 2	136.0 x 2	7.2
9LOD/H	4.5 x 2	6.8 x 2	11.0 x 2	2.0	7.3 x 2	9.6 x 2	59.5 x 2	7.2	4.5 x 2	6.5 x 2	11.0 x 2	2.0	12.6 x 2	19.1 x 2	136.0 x 2	7.2
9LUF	5.0 x 2	6.8 x 2	11.0 x 2	2.2	8.1 x 2	9.6 x 2	59.5 x 2	8.8	5.0 x 2	6.5 x 2	11.0 x 2	2.2	14.0 x 2	19.1 x 2	136.0 x 2	8.8
9LOF	4.5 x 2	6.8 x 2	11.0 x 2	2.0	8.0 x 2	9.6 x 2	59.5 x 2	8.8	4.5 x 2	6.5 x 2	11.0 x 2	2.0	13.9 x 2	19.1 x 2	136.0 x 2	8.8

50 Hz / R 407C

Model	STANDARD POWER SUPPLY								OPTIONAL POWER SUPPLY							
	FAN 1ph – 230V				COMPRESSOR 3ph – 400V				FAN 1ph – 230V				COMPRESSOR 3ph – 230V			
	OA	FLA	LRA	operating power (kW)	OA	FLA	LRA	operating power (kW)	OA	FLA	LRA	operating power (kW)	OA	FLA	LRA	operating power (kW)
OPTIONAL R 407C																
4PUA/W (*)	1.4	2.1	3.1	0.3	6.8	10.9	45.0	1.5	1.4	2.1	3.1	0.3	6.8	10.9	45.0	1.5
4GUA/W	2.6	3.8	4.4	0.6	4.2	5.5	38.5	2.2	2.6	3.8	4.4	0.6	7.3	10.9	80.9	2.2
6PUA/W	2.6	4.5	8.0	0.4	4.8	6.3	43.5	2.5	2.6	6.5	5.5	0.4	8.3	12.4	91.4	2.5
6GUA/W	3.3	4.5	8.0	0.5	6.0	7.5	51.0	3.1	3.3	6.5	5.5	0.5	10.4	14.8	108.0	3.1
8PUA/W	4.5	7.0	7.1	0.9	6.0	7.5	51.0	3.1	4.5	7.0	7.1	0.9	10.4	14.8	108.0	3.1
8GUA/W	5.4	7.0	7.1	1.2	7.6	9.6	59.5	3.8	5.4	7.0	7.1	1.2	13.1	19.1	136.0	3.8
5PUA/W (*)	1.4 x 2	2.1 x 2	3.1 x 2	0.6	6.8 x 2	10.9 x 2	45.0 x 2	3.0	1.4 x 2	2.1 x 2	3.1 x 2	0.6	6.8 x 2	10.9 x 2	45.0 x 2	3.0
5GUA/W	2.6 x 2	3.8 x 2	4.4 x 2	1.2	4.2 x 2	5.5 x 2	38.5 x 2	4.4	2.6 x 2	3.8 x 2	4.4 x 2	1.2	7.3 x 2	10.9 x 2	80.9 x 2	4.4
7PUA/W	2.6 x 2	4.5 x 2	8.0 x 2	0.8	4.8 x 2	6.3 x 2	43.5 x 2	5.0	2.6 x 2	6.5 x 2	5.5 x 2	0.8	8.3 x 2	12.4 x 2	91.4 x 2	5.0
7GUA/W	3.3 x 2	4.5 x 2	8.0 x 2	1.0	6.0 x 2	7.5 x 2	51.0 x 2	6.2	3.3 x 2	6.5 x 2	5.5 x 2	1.0	10.4 x 2	14.8 x 2	108.0 x 2	6.2
9PUA/W	4.5 x 2	7.0 x 2	7.1 x 2	1.8	6.0 x 2	7.5 x 2	51.0 x 2	6.2	4.5 x 2	7.0 x 2	7.1 x 2	1.8	10.4 x 2	14.8 x 2	108.0 x 2	6.2
9GUA/W	5.4 x 2	7.0 x 2	7.1 x 2	2.4	7.6 x 2	9.6 x 2	59.5 x 2	7.6	5.4 x 2	7.0 x 2	7.1 x 2	2.4	13.1 x 2	19.1 x 2	136.0 x 2	7.6
4POA/W (*)	1.2	2.1	3.1	0.3	6.8	10.9	45.0	1.5	1.2	2.1	3.1	0.3	6.8	10.9	45.0	1.5
4GOA/W	2.5	3.8	4.4	0.5	4.2	5.5	38.5	2.2	2.5	3.8	4.4	0.5	7.3	10.9	80.9	2.2
6POA/W	2.2	4.5	8.0	0.3	4.8	6.3	43.5	2.5	2.2	6.5	5.5	0.3	8.3	12.4	91.4	2.5
6GOA/W	3.1	4.5	8.0	0.5	6.0	7.5	51.0	3.1	3.1	6.5	5.5	0.5	10.4	14.8	108.0	3.1
8POA/W	3.9	6.8	11.0	0.8	6.0	7.5	51.0	3.1	3.9	7.0	7.1	0.8	10.4	14.8	108.0	3.1
8GOA/W	4.7	6.8	11.0	1.1	7.6	9.6	59.5	3.8	4.7	7.0	7.1	1.1	13.1	19.1	136.0	3.8
4PCA/W (*)	1.4	2.1	3.1	0.3	6.8	10.9	45.0	1.5	1.4	2.1	3.1	0.3	6.8	10.9	45.0	1.5
4GCA/W	2.4	3.8	4.4	0.6	4.2	5.5	38.5	2.2	2.4	3.8	4.4	0.6	7.3	10.9	80.9	2.2
6PCA/W	2.2	4.5	8.0	0.4	4.8	6.3	43.5	2.5	2.2	4.5	8.0	0.4	8.3	12.4	91.4	2.5
8PCA/W	4.2	6.8	11.0	0.8	6.0	7.5	51.0	3.1	4.2	6.8	11.0	0.8	10.4	14.8	108.0	3.1
5POA/W (*)	1.2 x 2	2.1 x 2	3.1 x 2	0.6	6.8 x 2	10.9 x 2	45.0 x 2	3.0	1.2 x 2	2.1 x 2	3.1 x 2	0.6	6.8 x 2	10.9 x 2	45.0 x 2	3.0
5GOA/W	2.5 x 2	3.8 x 2	4.4 x 2	1.0	4.2 x 2	5.5 x 2	38.5 x 2	4.4	2.5 x 2	3.8 x 2	4.4 x 2	1.0	7.3 x 2	10.9 x 2	80.9 x 2	4.4
7POA/W	2.2 x 2	4.5 x 2	8.0 x 2	0.6	4.8 x 2	6.3 x 2	43.5 x 2	5.0	2.2 x 2	6.5 x 2	5.5 x 2	0.6	8.3 x 2	12.4 x 2	91.4 x 2	5.0
7GOA/W	3.1 x 2	4.5 x 2	8.0 x 2	1.0	6.0 x 2	7.5 x 2	51.0 x 2	6.2	3.1 x 2	6.5 x 2	5.5 x 2	1.0	10.4 x 2	14.8 x 2	108.0 x 2	6.2
9POA/W	3.9 x 2	6.8 x 2	11.0 x 2	1.6	6.0 x 2	7.5 x 2	51.0 x 2	6.2	3.9 x 2	7.0 x 2	7.1 x 2	1.6	10.4 x 2	14.8 x 2	108.0 x 2	6.2
9GOA/W	4.7 x 2	6.8 x 2	11.0 x 2	2.2	7.6 x 2	9.6 x 2	59.5 x 2	7.6	4.7 x 2	7.0 x 2	7.1 x 2	2.2	13.1 x 2	19.1 x 2	136.0 x 2	7.6
8GUD/H	5.0	6.8	11.0	1.1	7.6	9.6	59.5	3.8	5.0	6.8	11.0	1.1	13.1	19.1	136.0	3.8
8GOD/H	4.5	6.8	11.0	1.0	7.6	9.6	59.5	3.8	4.5	6.8	11.0	1.0	13.1	19.1	136.0	3.8
8GUF	5.0	6.8	11.0	1.1	8.6	9.6	59.5	4.7	5.0	6.8	11.0	1.1	14.9	19.1	136.0	4.7
8GOF	4.5	6.8	11.0	1.0	8.5	9.6	59.5	4.6	4.5	6.8	11.0	1.0	14.7	19.1	136.0	4.6
9GUD/H	5.0 x 2	6.8 x 2	11.0 x 2	2.2	7.6 x 2	9.6 x 2	59.5 x 2	7.6	5.0 x 2	6.8 x 2	11.0 x 2	2.2	13.1 x 2	19.1 x 2	136.0 x 2	7.6
9GOD/H	4.5 x 2	6.8 x 2	11.0 x 2	2.0	7.6 x 2	9.6 x 2	59.5 x 2	7.6	4.5 x 2	6.8 x 2	11.0 x 2	2.0	13.1 x 2	19.1 x 2	136.0 x 2	7.6
9GUF	5.0 x 2	6.8 x 2	11.0 x 2	2.2	8.6 x 2	9.6 x 2	59.5 x 2	9.4	5.0 x 2	6.8 x 2	11.0 x 2	2.2	14.9 x 2	19.1 x 2	136.0 x 2	9.4
9GOF	4.5 x 2	6.8 x 2	11.0 x 2	2.0	8.5 x 2	9.6 x 2	59.5 x 2	9.2	4.5 x 2	6.8 x 2	11.0 x 2	2.0	14.7 x 2	19.1 x 2	136.0 x 2	9.2

- 1) Fan OA is for standard unit operating at the standard pressure drop.
- 2) Compressor OA is referred to – room conditions: 24°C, 50% RH; condensing temperature: 45°C. A/W/D/H models
- 3) Compressor OA is referred to – room conditions: 24°C, 50% RH; ext. temperature: 35°C. F models
- 4) Compressor FLA is for the contemporary conditions of minimum evaporating pressure and maximum condensing pressures.

60 Hz / R 22

Model	FAN 1ph – 230V				COMPRESSOR				
	OA	FLA	LRA	operating power (kW)	OA	FLA	LRA	operating power (kW)	power supply (V/ph/Hz)
STANDARD R 22									
4MUA	1.5	1.5	2.7	0.3	6.0	10.3	36.5	1.7	230/1/60
4SUA/W	2.3	2.9	4.3	0.5	6.5	11.4	56.0	1.7	208–230/1/60
4LUA/W	4.3	4.8	5.6	1.0	6.6	11.4	83.0	2.5	200–230/3/60
6SUA/W	3.7	5.4	9.6	0.7	7.8	13.4	95.0	3.0	200–230/3/60
6LUA/W	4.0	5.4	9.6	0.8	5.9	7.8	57.0	3.5	380/3/60
8SUA/W	5.9	7.0	11.3	1.3	5.9	7.8	57.0	3.5	380/3/60
8LUA/W	7.1	7.0	11.3	1.6	7.4	10.7	64.0	4.3	380/3/60
5SUA/W	2.3 x 2	2.9 x 2	4.3 x 2	1.0	6.5 x 2	11.4 x 2	56.0 x 2	3.4	208–230/1/60
5LUA/W	4.3 x 2	4.8 x 2	5.6 x 2	2.0	6.6 x 2	11.4 x 2	83.0 x 2	5.0	200–230/3/60
7SUA/W	3.7 x 2	5.4 x 2	9.6 x 2	1.4	7.8 x 2	13.4 x 2	95.0 x 2	6.0	200–230/3/60
7LUA/W	4.0 x 2	5.4 x 2	9.6 x 2	1.6	5.9 x 2	7.8 x 2	57.0 x 2	7.0	380/3/60
9SUA/W	5.9 x 2	7.0 x 2	11.3 x 2	2.6	5.9 x 2	7.8 x 2	57.0 x 2	7.0	380/3/60
9LUA/W	7.1 x 2	7.0 x 2	11.3 x 2	3.2	7.4 x 2	10.7 x 2	64.0 x 2	8.6	380/3/60
4MOA	1.2	1.5	2.7	0.2	5.9	10.3	36.5	1.7	230/1/60
4SOA/W	2.1	2.9	4.3	0.5	6.5	11.4	56.0	1.7	208–230/1/60
4LOA/W	4.1	4.8	5.6	1.0	6.6	11.4	83.0	2.5	200–230/3/60
6SOA/W	3.3	5.4	9.6	0.7	7.8	13.9	95.0	3.0	200–230/3/60
6LOA/W	3.7	5.4	9.6	0.8	5.9	7.8	57.0	3.5	380/3/60
8SOA/W	5.1	7.0	11.3	1.1	5.9	7.8	57.0	3.5	380/3/60
8LOA/W	6.2	7.0	11.3	1.4	7.4	10.7	64.0	4.3	380/3/60
4SCA/W	1.9	2.9	4.3	0.4	6.5	11.4	56.0	1.7	208–230/1/60
4LCA/W	3.9	4.8	5.6	1.0	6.6	11.4	83.0	2.5	200–230/3/60
6SCA/W	2.5	6.4	9.6	0.5	7.8	13.9	95.0	3.0	200–230/3/60
8SCA/W	4.6	7.0	11.3	1.1	5.9	7.8	57.0	3.5	380/3/60
5SOA/W	2.1 x 2	2.9 x 2	4.3 x 2	3.0	6.5 x 2	11.4 x 2	56.0 x 2	3.4	208–230/1/60
5LOA/W	4.1 x 2	4.8 x 2	5.6 x 2	2.0	6.6 x 2	11.4 x 2	83.0 x 2	5.0	200–230/3/60
7SOA/W	3.3 x 2	5.4 x 2	9.6 x 2	1.4	7.8 x 2	13.9 x 2	95.0 x 2	6.0	200–230/3/60
7LOA/W	3.7 x 2	5.4 x 2	9.6 x 2	1.6	5.9 x 2	7.8 x 2	57.0 x 2	7.0	380/3/60
9SOA/W	5.1 x 2	7.0 x 2	11.3 x 2	2.2	5.9 x 2	7.8 x 2	57.0 x 2	7.0	380/3/60
9LOA/W	6.2 x 2	7.0 x 2	11.3 x 2	2.8	7.4 x 2	10.7 x 2	64.0 x 2	8.6	380/3/60
4LUC	4.3	4.8	5.6	1.0					
6LUC	4.0	5.4	9.6	0.8					
8LUC	7.1	7.0	11.3	1.6					
4LOC	4.1	4.8	5.6	1.0					
6LOC	3.7	6.4	9.6	0.8					
8LOC	6.2	7.0	11.3	1.4					
8LUD/H	6.6	7.0	11.3	1.5	7.3	10.7	64.0	4.4	380/3/60
8LOD/H	5.8	7.0	11.3	1.4	7.2	10.7	64.0	4.4	380/3/60
8LUF	6.6	7.0	11.3	1.5	8.7	10.7	64.0	5.2	380/3/60
8LOF	5.8	7.0	11.3	1.4	8.7	10.7	64.0	5.2	380/3/60
9LUD/H	6.6 x 2	7.0 x 2	11.3 x 2	3.0	7.3 x 2	10.7 x 2	64.0 x 2	8.8	380/3/60
9LOD/H	5.8 x 2	7.0 x 2	11.3 x 2	2.8	7.2 x 2	10.7 x 2	64.0 x 2	8.8	380/3/60
9LUF	6.6 x 2	7.0 x 2	11.3 x 2	3.0	8.8 x 2	10.7 x 2	64.0 x 2	10.4	380/3/60
9LOF	5.8 x 2	7.0 x 2	11.3 x 2	2.8	8.8 x 2	10.7 x 2	64.0 x 2	10.4	380/3/60

60 Hz / R 407C

Model	FAN 1ph – 230V				COMPRESSOR				
	OA	FLA	LRA	operating power (kW)	OA	FLA	LRA	operating power (kW)	power supply (V/ph/Hz)
OPTIONAL R 407C									
4PUA/W	2.3	2.9	4.3	0.5	6.8	11.4	56.0	1.7	208–230/1/60
4GUA/W	4.3	4.8	5.6	1.0	7.3	11.4	83.0	2.6	200–230/3/60
6PUA/W	3.7	5.4	9.6	0.7	8.3	13.9	95.0	3.0	200–230/3/60
6GUA/W	4.0	5.4	9.6	0.8	6.0	7.8	57.0	3.7	380/3/60
8PUA/W	5.9	7.0	11.3	1.3	6.0	7.8	57.0	3.7	380/3/60
8GUA/W	7.1	7.0	11.3	1.6	7.6	10.7	64.0	4.6	380/3/60
5PUA/W	2.3 x 2	2.9 x 2	4.3 x 2	1.0	6.8 x 2	11.4 x 2	56.0 x 2	3.4	208–230/1/60
5GUA/W	4.3 x 2	4.8 x 2	5.6 x 2	2.0	7.3 x 2	11.4 x 2	83.0 x 2	5.2	200–230/3/60
7PUA/W	3.7 x 2	5.4 x 2	9.6 x 2	1.4	8.3 x 2	13.9 x 2	95.0 x 2	6.0	200–230/3/60
7GUA/W	4.0 x 2	5.4 x 2	9.6 x 2	1.6	6.0 x 2	7.8 x 2	57.0 x 2	7.4	380/3/60
9PUA/W	5.9 x 2	7.0 x 2	11.3 x 2	2.6	6.0 x 2	7.8 x 2	57.0 x 2	7.4	380/3/60
9GUA/W	7.1 x 2	7.0 x 2	11.3 x 2	3.2	7.6 x 2	10.7 x 2	64.0 x 2	9.2	380/3/60
4POA/W	2.1	2.9	4.3	0.5	6.8	11.4	56.0	1.8	208–230/1/60
4GOA/W	4.1	4.8	5.6	1.0	7.3	11.4	83.0	2.6	200–230/3/60
6POA/W	3.3	5.4	9.6	0.7	8.3	13.9	95.0	3.0	200–230/3/60
6GOA/W	3.7	5.4	9.6	0.8	6.0	7.8	57.0	3.7	380/3/60
8POA/W	5.1	7.0	11.3	1.1	6.0	7.8	57.0	3.7	380/3/60
8GOA/W	6.2	7.0	11.3	1.4	7.6	10.7	64.0	4.6	380/3/60
4PCA/W	1.9	2.9	4.3	0.4	6.8	11.4	56.0	1.8	208–230/1/60
4GCA/W	2.9	4.8	5.6	1.0	7.3	11.4	83.0	2.6	200–230/3/60
6PCA/W	3.9	5.4	9.6	0.5	8.3	13.9	95.0	3.0	200–230/3/60
8PCA/W	4.6	7.0	11.3	1.1	6.0	7.8	57.0	3.7	380/3/60
5POA/W	2.1 x 2	2.9 x 2	4.3 x 2	1.0	6.8 x 2	11.4 x 2	56.0 x 2	3.6	208–230/1/60
5GOA/W	4 x 2.1	4.8 x 2	5.6 x 2	2.0	7.3 x 2	11.4 x 2	83.0 x 2	5.2	200–230/3/60
7POA/W	3.3 x 2	5.4 x 2	9.6 x 2	1.4	8.3 x 2	13.9 x 2	95.0 x 2	6.0	200–230/3/60
7GOA/W	3.7 x 2	5.4 x 2	9.6 x 2	1.6	6.0 x 2	7.8 x 2	57.0 x 2	7.4	380/3/60
9POA/W	5.1 x 2	7.0 x 2	11.3 x 2	2.2	6.0 x 2	7.8 x 2	57.0 x 2	7.4	380/3/60
9GOA/W	6.2 x 2	7.0 x 2	11.3 x 2	2.8	7.6 x 2	10.7 x 2	64.0 x 2	9.2	380/3/60
8GUD/H	6.6	7.0	11.3	1.5	7.6	10.7	64.0	4.6	380/3/60
8GOD/H	5.8	7.0	11.3	1.4	7.6	10.7	64.0	4.6	380/3/60
8GUF	6.6	7.0	11.3	1.5	7.5	10.7	64.0	5.5	380/3/60
8GOF	5.8	7.0	11.3	1.4	7.5	10.7	64.0	5.5	380/3/60
9GUD/H	6.6 x 2	7.0 x 2	11.3 x 2	3.0	7.6 x 2	10.7 x 2	64.0 x 2	9.2	380/3/60
9GOD/H	5.8 x 2	7.0 x 2	11.3 x 2	2.8	7.6 x 2	10.7 x 2	64.0 x 2	9.2	380/3/60
9GUF	6.6 x 2	7.0 x 2	11.3 x 2	3.0	7.5 x 2	10.7 x 2	64.0 x 2	11.0	380/3/60
9GOF	5.8 x 2	7.0 x 2	11.3 x 2	2.8	7.5 x 2	10.7 x 2	64.0 x 2	11.0	380/3/60

- 1) Fan OA is for standard unit operating at the standard pressure drop.
- 2) Compressor OA is referred to – room conditions: 24°C, 50% RH; condensing temperature: 45°C. A/W/D/H models
- 3) Compressor OA is referred to – room conditions: 24°C, 50% RH; ext. temperature: 35°C. F models
- 4) Compressor FLA is for the contemporary conditions of minimum evaporating pressure and maximum condensing pressure.

OPTIONAL

Model	400 V/3 ph/50–60 Hz				230 V/3 ph/50–60 Hz			
	Electrical heating		Humidifier		Electrical heating		Humidifier	
	FLA	nominal power [kW]	FLA	nominal power [kW]	FLA	nominal power [kW]	FLA	nominal power [kW]
4S/P/M U/O/C A/W (*)	6.5	4.5	6.5	1.5	11.3	4.5	6.5	1.5
4L/G U/O/C A/W/C (*)	6.5	4.5	6.5	1.5	11.3	4.5	6.5	1.5
6S/P U/O/C A/W	6.5	4.5	5.0	3.4	11.3	4.5	8.1	3.4
6L/G U/O A/W/C	6.5	4.5	5.0	3.4	11.3	4.5	8.1	3.4
8S/P U/O A/W	6.5	4.5	5.0	3.4	11.3	4.5	8.1	3.4
8L/G U/O A/W/F/D/H/C	6.5	4.5	5.0	3.4	11.3	4.5	8.1	3.4
5S/P U/O A/W (*)	6.5 x 2	9.0	6.5	3.0	11.3 x 2	9.0	6.5	3.0
5L/G U/O A/W/C (*)	6.5 x 2	9.0	6.5	3.0	11.3 x 2	9.0	6.5	3.0
7S/P U/O A/W	6.5 x 2	9.0	5.0	6.8	11.3 x 2	9.0	8.1	6.8
7L/G U/O A/W/C	6.5 x 2	9.0	5.0	6.8	11.3 x 2	9.0	8.1	6.8
9S/P U/O A/W	6.5 x 2	9.0	5.0	6.8	11.3 x 2	9.0	8.1	6.8
9L/G U/O A/W/F/D/H/C	6.5 x 2	9.0	5.0	6.8	11.3 x 2	9.0	8.1	6.8

Electrical heating values are for maximum heating (3 steps).

(*) The humidifiers in the models 4 M and 4Sx and 4Lx are single-phase (230V/1ph/50–60 Hz)

CONFIGURATION WITH OPTIONAL FANS TYPE “HPFan”

MODEL	COMPONENTS	POWER SUPPLY 230–400/3/50 + N			POWER SUPPLY 230–380/3/60 + N		
		OA	FLA	LRA	OA	FLA	LRA
4S/P/M U A/W	HP FAN	2.4	3.2	6.5	3.72	4.3	
4S/P/M O A/W		2.3	3.2	6.5	3.48	4.3	
4S/P C A/W			3.2	6.5	3.01	4.3	
4L/G U A/W/C		2.9	3.2	6.5	4.82	6.3	
4L/G O A/W/C		2.8	3.2	6.5	5.03	6.3	
4L/G C A/W			3.2	6.5	4.86	6.3	
6S/P U A/W		5.3	6.5	12.0	5.71	6.3	
6S/P O A/W		5.6	6.5	12.0	5.51	6.3	
6S/P C A/W			6.5	12.0	5.11	6.3	
6L/G U A/W/C		5.4	6.5	12.0	6.09	6.3	
6L/G O A/W/C		5.6	6.5	12.0	5.89	6.3	
8S/P U A/W		7.5	9.4	17.0			
8S/P O A/W		7.6	9.4	17.0			
8S/P C A/W				17.0			
8L/G U A/W/C/D/F/H		7.6	9.4	17.0			
8L/G O A/W/C/D/F/H		7.8	9.4	17.0			
5S/P U A/W		2.4 x 2	3.2 x 2	6.5 x 2	3.72 x 2	4.3 x 2	
5S/P O A/W		2.3 x 2	3.2 x 2	6.5 x 2	3.48 x 2	4.3 x 2	
5L/G U A/W/C		2.9 x 2	3.2 x 2	6.5 x 2	4.82 x 2	6.3 x 2	
5L/G O A/W/C		2.8 x 2	6.5 x 2	6.5 x 2	5.03 x 2	6.3 x 2	
7S/P U A/W		5.3 x 2	6.5 x 2	12.0 x 2	5.71 x 2	6.3 x 2	
7S/P O A/W		5.6 x 2	6.5 x 2	12.0 x 2	5.51 x 2	6.3 x 2	
7L/G U A/W/C		5.4 x 2	6.5 x 2	12.0 x 2	6.09 x 2	6.3 x 2	
7L/G O A/W/C		5.6 x 2	6.5 x 2	12.0 x 2	5.89 x 2	6.3 x 2	
9S/P U A/W		7.5 x 2	9.4 x 2	17.0 x 2			
9S/P O A/W		7.6 x 2	9.4 x 2	17.0 x 2			
9L/G U A/W/C/D/F/H		7.6 x 2	9.4 x 2	17.0 x 2			
9L/G O A/W/C/D/F/H		7.8 x 2	9.4 x 2	17.0 x 2			

Fan OA is for standard unit operating at the standard pressure drop.

8 – Aeraulic features

8.1 – Useful available heads

The air conditioners of the Hiflex series are supplied with electric fans sized for a useful head of 20 Pa for the models under, 50 Pa for the models over.

When the pressure drop on the air side are higher or some ducts are provided on the air circuit, the air flows vary as shown below.

The boldface numbers refer to the rated value.

Available heads – 50 Hz

4MU A		4SU A/W 5SU A/W		4LU A/W/C 5LU A/W		6SU A/W 7SU A/W		6LUA/W/C 7LU A/W		8SU A/W 9SU A/W		8LU A/W/C 9LU A/W		8LU /D/H/F 9LU /D/H/F	
Air flow	Available head	Air flow	Available head	Air flow	Available head	Air flow	Available head	Air flow	Available head	Air flow	Available head	Air flow	Available head	Air flow	Available head
[m³/s]	[Pa]	[m³/s]	[Pa]	[m³/s]	[Pa]	[m³/s]	[Pa]	[m³/s]	[Pa]	[m³/s]	[Pa]	[m³/s]	[Pa]	[m³/s]	[Pa]
0.225	133	0.350	83	0.500	167	0.575	108	0.625	110	0.950	161	1.000	148	0.800	170
0.250	120	0.375	73	0.525	152	0.600	97	0.650	99	0.975	158	1.025	143	0.850	155
0.275	103	0.400	60	0.550	133	0.625	87	0.675	88	1.000	154	1.050	136	0.900	141
0.300	88	0.418	50	0.575	103	0.650	75	0.700	75	1.025	149	1.075	129	0.950	128
0.325	76	0.425	46	0.600	80	0.675	62	0.725	63	1.050	142	1.100	121	1.000	113
0.350	65	0.450	28	0.625	45	0.696	50	0.750	50	1.075	133	1.125	112	1.050	97
0.375	53	0.460	20	0.640	20	0.700	48	0.775	35	1.100	120	1.150	102	1.100	79
0.400	40	0.475	8	0.650	02	0.725	32	0.800	20	1.125	105	1.175	91	1.150	57
0.425	24	0.485	0	0.651	0	0.743	20	0.825	4	1.150	85	1.200	80	1.200	33
0.430	20					0.750	15	0.831	0	1.175	61	1.225	68	1.220	20
0.450	3					0.770	0			1.186	50	1.250	55	1.250	4
0.453	0									1.200	33	1.259	50		
										1.210	20	1.275	41		
										1.225	0	1.300	26		
												1.310	20		
												1.325	10		
												1.341	0		

4MO A		4SO A/W 5SO A/W		4LO A/W/C 5LO A/W		6SO A/W 7SO A/W		6LO A/W/C 7LO A/W		8SO A/W 9SO A/W		8LO A/W/C 9LO A/W		8LO /D/H/F 9LO /D/H/F	
Air flow	Available head	Air flow	Available head	Air flow	Available head	Air flow	Available head	Air flow	Available head	Air flow	Available head	Air flow	Available head	Air flow	Available head
[m³/s]	[Pa]	[m³/s]	[Pa]	[m³/s]	[Pa]	[m³/s]	[Pa]	[m³/s]	[Pa]	[m³/s]	[Pa]	[m³/s]	[Pa]	[m³/s]	[Pa]
0.225	99	0.375	64	0.450	163	0.475	139	0.575	124	0.875	115	0.975	106	0.800	142
0.250	78	0.400	50	0.475	151	0.500	130	0.600	114	0.900	109	1.000	99	0.840	126
0.275	52	0.425	38	0.500	136	0.525	121	0.625	103	0.925	104	1.025	91	0.880	112
0.300	27	0.450	15	0.525	118	0.575	100	0.650	91	0.950	99	1.050	82	0.920	98
0.325	4	0.467	0	0.550	95	0.600	89	0.675	79	0.975	93	1.075	72	0.960	84
0.330	0			0.575	68	0.625	78	0.700	67	1.000	86	1.100	61	1.000	69
				0.589	50	0.675	52	0.725	53	1.025	77	1.125	50	1.040	55
				0.600	35	0.678	50	0.730	50	1.050	67	1.150	37	1.050	50
				0.623	0	0.700	36	0.750	39	1.075	53	1.175	23	1.080	38
						0.725	20	0.775	24	1.080	50	1.200	9	1.120	18
						0.750	2	0.800	8	1.100	37	1.216	0		
						0.754	0	0.812	0	1.125	18				
										1.145	0				

4SC A/W		4LC A/W		6SC A/W		8SC A/W	
Air flow	Available head	Air flow	Available head	Air flow	Available head	Air flow	Available head
[m ³ /s]	[Pa]	[m ³ /s]	[Pa]	[m ³ /s]	[Pa]	[m ³ /s]	[Pa]
0.300	81	0.375	191	0.375	164	0.800	107
0.325	68	0.400	159	0.400	157	0.825	99
0.350	55	0.425	130	0.425	151	0.850	91
0.360	50	0.450	111	0.450	145	0.875	84
0.375	41	0.475	99	0.475	139	0.900	76
0.400	25	0.500	82	0.500	132	0.925	67
0.425	6	0.525	56	0.525	124	0.950	58
		0.530	50	0.550	115	0.970	50
		0.550	23	0.575	106	0.975	48
				0.600	94	1.000	37
				0.625	82	1.025	24
				0.650	68	1.050	8
				0.675	54	1.075	
				0.680	50	1.100	
				0.700	38	1.125	
				0.725	21	1.150	
				0.750	3		

Available heads – 60 Hz

4MU A		4SU A/W 5SU A/W		4LU A/W/C 5LU A/W		6SU A/W 7SU A/W		6LU A/W/C 7LU A/W		8SU A/W 9SU A/W		8LU A/W/C 9LU A/W		8LU /D/H/F 9LU /D/H/F	
Air flow	Available head	Air flow	Available head	Air flow	Available head	Air flow	Available head	Air flow	Available head	Air flow	Available head	Air flow	Available head	Air flow	Available head
[m ³ /s]	[Pa]	[m ³ /s]	[Pa]	[m ³ /s]	[Pa]	[m ³ /s]	[Pa]	[m ³ /s]	[Pa]	[m ³ /s]	[Pa]	[m ³ /s]	[Pa]	[m ³ /s]	[Pa]
0.150	250	0.275	202	0.375	375	0.375	270	0.375	289	0.800	268	0.950	266	0.950	233
0.175	241	0.300	185	0.400	350	0.400	261	0.400	280	0.825	259	0.975	261	0.975	227
0.200	231	0.325	169	0.425	322	0.425	252	0.425	270	0.850	251	1.000	255	1.000	219
0.225	219	0.350	155	0.450	291	0.450	242	0.450	261	0.875	243	1.025	250	1.025	212
0.250	205	0.375	142	0.475	259	0.475	233	0.475	251	0.900	237	1.050	243	1.050	203
0.275	188	0.400	130	0.500	227	0.500	223	0.500	241	0.925	230	1.075	236	1.075	194
0.300	167	0.425	118	0.525	196	0.525	212	0.525	232	0.950	224	1.100	227	1.100	184
0.325	142	0.450	105	0.550	166	0.550	201	0.550	222	0.975	217	1.125	218	1.125	172
0.350	113	0.475	90	0.575	136	0.575	190	0.575	212	1.000	206	1.150	208	1.150	160
0.375	78	0.500	71	0.600	104	0.600	178	0.600	201	1.025	190	1.175	196	1.175	146
0.400	38	0.525	48	0.625	63	0.625	165	0.625	191	1.050	164	1.200	183	1.200	132
0.410	20	0.549	20	0.644	20	0.650	152	0.650	180	1.075	124	1.225	169	1.225	115
0.420	0	0.563	0	0.650	3	0.675	137	0.675	168	1.100	61	1.250	154	1.250	97
				0.651	0	0.700	121	0.700	156	1.122	20	1.275	135	1.275	77
						0.725	104	0.725	143	1.125	0	1.300	114	1.300	53
						0.750	83	0.750	129			1.325	87	1.325	24
						0.775	59	0.775	114			1.350	54	1.328	20
						0.800	28	0.800	98			1.371	20	1.343	0
						0.806	20	0.825	80			1.375	12		
						0.818	0	0.850	62			1.381	0		
								0.875	41						
								0.899	20						
								0.920	0						

4MO A		4SO A/W 5SO A/W		4LO A/W/C 5LO A/W		6SO A/W 7SO A/W		6LO A/W/C 7LO A/W		8SO A/W 9SO A/W		8LO A/W/C 9LO A/W		8LO /D/H/F 9LO /D/H/F	
Air flow [m ³ /s]	Available head [Pa]	Air flow [m ³ /s]	Available head [Pa]	Air flow [m ³ /s]	Available head [Pa]	Air flow [m ³ /s]	Available head [Pa]	Air flow [m ³ /s]	Available head [Pa]	Air flow [m ³ /s]	Available head [Pa]	Air flow [m ³ /s]	Available head [Pa]	Air flow [m ³ /s]	Available head [Pa]
0.150	213	0.275	195	0.375	363	0.375	267	0.375	286	0.800	233	0.950	221	0.950	192
0.175	191	0.300	177	0.400	336	0.400	258	0.400	276	0.825	223	0.975	214	0.975	183
0.200	166	0.325	160	0.425	306	0.425	248	0.425	266	0.850	215	1.000	206	1.000	174
0.225	137	0.350	144	0.450	274	0.450	238	0.450	256	0.875	207	1.025	198	1.025	164
0.250	103	0.375	130	0.475	240	0.475	228	0.475	246	0.900	199	1.050	189	1.050	153
0.275	64	0.400	116	0.500	206	0.500	217	0.500	236	0.925	190	1.075	178	1.075	141
0.300	20	0.425	102	0.525	172	0.525	207	0.525	226	0.950	177	1.100	167	1.100	129
0.310	0	0.450	87	0.550	140	0.550	195	0.550	216	0.975	159	1.125	155	1.125	115
		0.475	70	0.575	107	0.575	183	0.575	205	1.000	131	1.150	142	1.150	100
		0.500	50	0.600	72	0.600	171	0.600	194	1.025	89	1.175	128	1.175	84
		0.525	25	0.614	50	0.625	157	0.625	183	1.046	50	1.200	112	1.200	66
		0.545	0	0.625	29	0.650	143	0.650	171	1.050	24	1.225	95	1.222	50
				0.638	0	0.675	128	0.675	159	1.057	0	1.250	76	1.225	47
						0.700	111	0.700	146			1.275	55	1.250	26
						0.725	93	0.725	132			1.279	50	1.275	3
						0.750	72	0.750	117			1.300	30	1.278	0
						0.772	50	0.775	102			1.325	1		
						0.775	46	0.800	85			1.326	1		
						0.800	15	0.825	67						
						0.810	0	0.846	50						
								0.875	26						
								0.900	3						
								0.903	0						

4SC A/W		4LC A/W		6sC A/W		8SC A/W	
Air flow [m ³ /s]	Available head [Pa]	Air flow [m ³ /s]	Available head [Pa]	Air flow [m ³ /s]	Available head [Pa]	Air flow [m ³ /s]	Available head [Pa]
0.275	155	0.375	304	0.375	233	0.800	171
0.300	130	0.400	269	0.400	219	0.825	158
0.325	105	0.425	230	0.425	204	0.850	146
0.350	80	0.450	189	0.450	189	0.875	134
0.375	56	0.475	145	0.475	173	0.900	122
0.381	50	0.500	101	0.500	156	0.925	108
0.400	32	0.525	56	0.525	139	0.950	91
0.425	7	0.528	50	0.550	121	0.975	68
0.432	0	0.550	13	0.575	102	0.990	50
		0.557	0	0.600	82	1.000	36
				0.625	62	1.020	0
				0.639	50		
				0.650	40		
				0.675	16		
				0.692	0		

The static pressure increase at the different air flows is indicated hereinafter for a proper calculation of the required useful head. This increase must be taken into account if some optional devices are supplied.

9 – Sound Pressure Level

Hiflex units have been designed with particular care for sound and vibration problems. The complete mechanical insulation of the ventilating section, combined with the special study of the aerodynamic circuit as a consequence of accurate researches made in our thermodynamical laboratories and the oversizing of the components crossed by air offer the highest ventilation efficiency with the lowest sound emission.



9.1 – Sound emission spectra

The following tables show the noise levels for every octave band frequency.

Version UNDER – 50 Hz

Model	Mode	octave band frequency (Hz)									Sound Level [dB(A)]
		31.5	63	125	250	500	1000	2000	4000	8000	
4MUA	SPL(1)	45.1	42.5	42.5	46.6	40.4	37.8	34.2	27.6	18.0	43.5
	SPL(2)	49.1	54.8	47.9	48.0	40.9	39.7	35.0	28.0	19.0	44.9
	PWL(3)	64.6	64.6	66.1	67.1	66.1	63.6	60.1	56.1	51.1	68.5
4SUA/W	SPL(1)	47.1	44.5	44.5	48.6	42.4	39.8	36.2	29.6	20.0	45.5
	SPL(2)	51.1	56.8	49.9	50.0	42.9	41.7	37.0	30.0	21.0	46.9
	PWL(3)	66.6	66.6	68.1	69.1	68.1	65.6	62.1	58.1	53.1	70.5
4LUA/W	SPL(1)	50.4	47.3	48.7	53.9	46.3	43.8	40.2	34.2	24.1	49.9
	SPL(2)	50.5	52.4	50.9	53.4	46.4	44.8	40.4	34.1	24.1	50.1
	PWL(3)	73.4	73.4	74.9	75.9	74.9	72.4	68.9	64.9	59.9	77.3
4LUC	SPL(1)	50.4	47.3	48.7	53.5	46.3	43.8	40.2	34.2	24.1	49.8
	PWL(4)	73.4	73.4	74.9	75.9	74.9	72.4	68.9	64.9	59.9	77.3
5SUA/W	SPL(1)	50.1	47.5	47.5	51.6	45.4	42.8	39.2	32.6	23.0	48.5
	SPL(2)	54.1	59.8	52.9	53.0	45.9	44.7	40.0	33.0	24.0	49.9
	PWL(3)	69.6	69.6	71.1	72.1	71.1	68.6	65.1	61.1	56.1	73.5
5LUA/W	SPL(1)	53.4	50.3	51.7	56.9	49.3	46.8	43.2	37.2	27.1	52.9
	SPL(2)	53.5	55.4	53.9	56.4	49.4	47.8	43.4	37.1	27.1	53.1
	PWL(3)	76.4	76.4	77.9	78.9	77.9	75.4	71.9	67.9	62.9	80.3
6SUA/W	SPL(1)	54.7	49.5	50.0	52.4	46.4	44.3	41.0	35.2	24.2	49.8
	SPL(2)	54.5	59.0	50.7	52.9	46.1	44.5	41.0	35.3	24.9	50.0
	PWL(3)	72.3	72.3	73.8	74.8	73.8	71.3	67.8	63.8	58.8	76.2
6LUA/W	SPL(1)	55.0	51.0	50.0	52.9	50.4	45.2	41.3	36.0	25.3	51.4
	SPL(2)	54.7	58.7	51.1	53.3	49.3	45.3	41.8	36.3	25.8	51.3
	PWL(3)	72.7	72.7	74.2	75.2	74.2	71.7	68.2	64.2	59.2	76.6
6LUC	SPL(1)	55.0	51.0	50.0	52.9	50.4	45.2	41.3	36.0	25.3	51.4
	PWL(4)	72.7	72.7	74.2	75.2	74.2	71.7	68.3	64.2	59.2	76.6
7SUA/W	SPL(1)	57.7	52.5	53.0	55.4	49.4	47.3	44.0	38.2	27.2	52.8
	SPL(2)	57.5	62.0	53.7	55.9	49.1	47.5	44.0	38.3	27.9	53.0
	PWL(3)	75.3	75.3	76.8	77.8	76.8	74.3	70.8	66.8	61.8	79.2
7LUA/W	SPL(1)	58.0	54.0	53.0	55.9	53.4	48.2	44.3	39.0	28.3	54.4
	SPL(2)	57.7	61.7	54.1	56.3	52.3	48.3	44.8	39.3	28.8	54.3
	PWL(3)	75.7	75.7	77.2	78.2	77.2	74.7	71.2	67.2	62.2	79.6
8SUA/W	SPL(1)	54.4	51.2	50.6	49.1	48.3	43.3	40.6	34.9	23.0	49.4
	SPL(2)	53.6	56.4	59.3	49.1	48.4	43.5	40.6	35.0	23.5	50.3
	PWL(3)	73.7	73.7	75.2	76.2	75.2	72.7	69.2	65.2	60.2	77.6
8LUA/W	SPL(1)	56.2	52.8	53.4	52.7	48.3	46.3	43.8	38.3	26.7	51.7
	SPL(2)	55.9	63.6	59.4	52.1	49.3	46.7	44.2	38.5	26.7	52.6
	PWL(3)	75.8	75.8	77.3	78.3	77.3	74.8	71.3	67.3	62.3	79.7

Model	Mode	octave band frequency (Hz)									Sound Level [dB(A)]
		31.5	63	125	250	500	1000	2000	4000	8000	
8LUC	SPL(1)	56.2	52.8	53.4	52.7	48.3	46.3	43.8	38.3	26.7	51.7
	PWL(4)	75.8	75.8	77.3	78.3	77.3	74.8	71.3	67.3	62.3	79.7
9SUA/W	SPL(1)	57.4	54.2	53.6	52.1	51.3	46.3	43.6	37.9	26.0	52.4
	SPL(2)	56.6	59.4	62.3	52.1	51.4	46.5	43.6	38.0	26.5	53.3
	PWL(3)	76.7	76.7	78.2	79.2	78.2	75.7	72.2	68.2	63.2	80.6
9LUA/W	SPL(1)	59.2	55.8	56.4	55.7	51.3	49.3	46.8	41.3	29.7	54.7
	SPL(2)	58.9	66.6	62.4	55.1	52.3	49.7	47.2	41.5	29.7	55.6
	PWL(3)	78.8	78.8	80.3	81.3	80.3	77.8	74.3	70.3	65.3	82.7
8LUD/H/F	SPL(1)	55.7	52.3	52.9	52.2	47.8	45.8	43.3	37.8	26.2	51.2
	SPL(2)	55.4	63.1	58.9	51.6	48.8	46.2	43.7	38.0	26.2	52.1
	PWL(3)	75.3	75.3	76.8	77.8	76.8	74.3	70.8	66.8	61.8	79.2
9LUD/H/F	SPL(1)	58.7	55.3	55.9	55.2	50.8	48.8	46.3	40.8	29.2	54.2
	SPL(2)	58.4	66.1	61.9	54.6	51.8	49.2	46.7	41.0	29.2	55.1
	PWL(3)	78.3	78.3	79.8	80.8	79.8	77.3	73.8	69.8	64.8	82.2

NOTES:

- (1) Only ventilation (20 Pa back pressure), 2 m in front of the unit and 1 m height, in free field conditions.
- (2) Working compressor (20 Pa back pressure), 2 m in front of the unit and 1 m height, in free field conditions.
- (3) Working compressor, on air delivery.
- (4) Only ventilation, on air delivery.

The sound pressure levels for each octave band are expressed in dB with tolerances of (-0/+2) dB.

Version UNDER – 60 HZ

Model	Mode	octave band frequency (Hz)									Sound Level [dB(A)]
		31.5	63	125	250	500	1000	2000	4000	8000	
4MUA	SPL(1)	43.4	41.0	41.8	44.7	40.2	36.3	32.2	25.1	15.4	42.1
	SPL(2)	47.4	53.3	47.2	46.1	40.7	38.2	33.0	25.5	16.4	43.6
	PWL(3)	62.9	63.1	65.4	65.2	65.9	62.1	58.1	53.6	48.5	67.2
4SUA/W	SPL(1)	49.7	47.5	47.4	50.1	44.8	43.4	39.8	33.9	26.1	48.3
	SPL(2)	53.7	59.8	52.8	51.5	45.3	45.3	40.6	34.3	27.1	49.8
	PWL(3)	69.2	69.6	71.0	70.6	70.5	69.2	65.7	62.4	59.2	73.7
4LUA/W	SPL(1)	49.8	47.1	48.2	53.5	45.4	43.0	39.2	33.4	23.3	49.2
	SPL(2)	49.9	52.2	50.4	53.0	45.5	44.0	39.4	33.3	23.3	49.4
	PWL(3)	72.8	73.2	74.4	75.5	74.0	71.6	67.9	64.1	59.1	76.4
4LUC	SPL(1)	49.8	47.1	48.2	53.1	45.4	43.0	39.2	33.4	23.3	49.1
	PWL(4)	72.8	73.2	74.4	75.5	74.0	71.6	67.9	64.1	59.1	76.4
5SUA/W	SPL(1)	52.7	50.5	50.4	53.1	47.8	46.4	42.8	36.9	29.1	51.3
	SPL(2)	56.7	62.8	55.8	54.5	48.3	48.3	43.6	37.3	30.1	52.8
	PWL(3)	72.2	72.6	74.0	73.6	73.5	72.2	68.7	65.4	62.2	76.7
5LUA/W	SPL(1)	52.8	50.1	51.2	56.5	48.4	46.0	42.2	36.4	26.3	52.2
	SPL(2)	52.9	55.2	53.4	56.0	48.5	47.0	42.4	36.3	26.3	52.4
	PWL(3)	75.8	76.2	77.4	78.5	77.0	74.6	70.9	67.1	62.1	79.4
6SUA/W	SPL(1)	57.7	50.0	55.6	53.9	46.9	45.8	42.3	36.6	26.0	51.2
	SPL(2)	57.5	59.5	56.3	54.4	46.6	46.0	42.3	36.7	26.7	51.5
	PWL(3)	75.3	72.8	79.4	76.3	74.3	72.8	69.1	65.2	60.6	77.5
6LUA/W	SPL(1)	59.3	52.8	64.0	55.7	52.2	47.3	44.3	39.2	29.4	54.7
	SPL(2)	59.0	60.5	65.1	56.1	51.1	47.4	44.8	39.5	29.9	54.9
	PWL(3)	77.0	74.5	88.2	78.0	76.0	73.8	71.2	67.4	63.3	79.7
6LUC	SPL(1)	59.3	52.8	64.0	55.7	52.2	47.3	44.3	39.2	29.4	54.7
	PWL(4)	77.0	74.5	88.2	78.0	76.0	73.8	71.2	67.4	63.3	79.7
7SUA/W	SPL(1)	60.7	53.0	58.6	56.9	49.9	48.8	45.3	39.6	29.0	54.2
	SPL(2)	60.5	62.5	59.30	57.4	49.6	49.0	45.3	39.7	29.7	54.5
	PWL(3)	78.3	75.8	82.4	79.3	77.3	75.8	72.1	68.2	63.6	80.5
7LUA/W	SPL(1)	62.3	55.8	67.0	58.7	55.2	50.3	47.3	42.2	32.4	57.7
	SPL(2)	62.0	63.5	68.1	59.1	54.1	50.4	47.8	42.5	32.9	57.9
	PWL(3)	80.0	77.5	91.2	81.0	79.0	76.8	74.2	70.4	66.3	82.7
8SUA/W	SPL(1)	45.5	44.0	48.2	45.6	46.1	40.2	37.3	31.2	18.4	46.6
	SPL(2)	44.7	49.2	56.9	45.6	46.2	40.4	37.3	31.3	18.9	47.6
	PWL(3)	64.8	66.5	72.8	72.7	73.0	69.6	65.9	61.5	55.6	74.6
8LUA/W	SPL(1)	67.6	53.0	53.1	53.3	49.0	46.8	44.4	38.9	27.6	52.3
	SPL(2)	67.3	63.8	59.1	52.7	50.0	47.2	44.8	39.1	27.6	53.1
	PWL(3)	87.2	76.0	77.0	78.9	78.0	75.3	71.9	67.9	63.2	80.3
8LUC	SPL(1)	67.6	53.0	53.1	53.3	49.0	46.8	44.4	38.9	27.6	52.3
	PWL(4)	87.2	76.0	77.0	78.9	78.0	75.3	71.9	67.9	63.2	80.3
9SUA/W	SPL(1)	48.5	47.0	51.2	48.6	49.1	43.2	40.3	34.2	21.4	49.6
	SPL(2)	47.7	52.2	59.9	48.6	49.2	43.4	40.3	34.3	21.9	50.2
	PWL(3)	67.8	69.5	75.8	75.7	76.0	72.6	68.9	64.5	58.6	77.6
9LUA/W	SPL(1)	70.6	56.0	56.1	56.3	52.0	49.8	47.4	41.9	30.6	55.3
	SPL(2)	70.3	66.8	62.1	55.7	53.0	50.2	47.8	42.1	30.6	56.1
	PWL(3)	90.2	79.0	80.0	81.9	81.0	78.3	74.9	70.9	66.2	83.3
8LUD/H/F	SPL(1)	67.1	52.5	52.6	52.8	48.5	46.3	43.9	38.4	27.1	51.8
	SPL(2)	66.8	63.3	58.6	52.2	49.5	46.7	44.3	38.6	27.1	52.6
	PWL(3)	86.7	75.5	76.5	78.4	77.5	74.8	71.4	67.4	62.7	79.8
9LUD/H/F	SPL(1)	70.1	55.5	55.6	55.8	51.5	49.3	46.9	41.4	30.1	54.8
	SPL(2)	69.8	66.3	61.6	55.2	52.5	49.7	47.3	41.6	30.1	55.6
	PWL(3)	89.7	78.5	79.5	81.4	80.5	77.8	74.4	70.4	65.7	82.8

NOTES:

- (1) Only ventilation (20 Pa back pressure), 2 m in front of the unit and 1 m height, in free field conditions.
- (2) Working compressor (20 Pa back pressure), 2 m in front of the unit and 1 m height, in free field conditions.
- (3) Working compressor, on air delivery.
- (4) Only ventilation, on air delivery.

The sound pressure levels for each octave band are expressed in dB with tolerances of (-0/+2) dB.

Version OVER – 50 Hz

Model	Mode	octave band frequency (Hz)									Sound Level [dB(A)]
		31.5	63	125	250	500	1000	2000	4000	8000	
4MOA	SPL(1)	52.7	50.8	53.3	50.8	39.6	37.8	30.3	26.2	14.4	45.4
	SPL(2)	52.6	50.4	53.3	50.0	39.6	37.8	29.4	25.2	14.4	45.0
	PWL(3)	62.7	62.7	64.2	65.2	64.2	61.7	58.2	54.2	49.2	66.6
4SOA/W	SPL(1)	54.7	52.8	55.3	52.8	41.6	39.8	32.3	28.2	16.4	47.4
	SPL(2)	54.6	52.4	55.3	52.0	41.6	39.8	31.4	27.2	16.4	47.0
	PWL(3)	64.7	64.7	66.2	67.2	66.2	63.7	60.2	56.2	51.2	68.6
4LOA/W	SPL(1)	58.9	57.7	60.6	57.3	46.9	45.1	36.7	32.5	21.7	52.3
	SPL(2)	58.9	57.7	60.6	57.3	46.9	45.1	36.7	32.5	21.7	52.3
	PWL(3)	73.6	73.6	75.1	76.1	75.1	72.6	69.1	65.1	60.1	77.5
4LOC	SPL(1)	58.9	57.7	60.6	57.3	46.9	45.1	36.7	32.5	21.7	52.3
	PWL(4)	73.6	73.6	75.1	76.1	75.1	72.6	69.1	65.1	60.1	77.5
5SOA/W	SPL(1)	57.7	55.8	58.3	55.8	44.6	42.8	35.3	31.2	19.4	50.4
	SPL(2)	57.6	55.4	58.3	55.0	44.6	42.8	34.4	30.2	19.4	50.0
	PWL(3)	67.7	67.7	69.2	70.2	69.2	66.7	63.2	59.2	54.2	71.6
5LOA/W	SPL(1)	61.9	60.7	63.6	60.3	49.9	48.1	39.7	35.5	24.7	55.3
	SPL(2)	61.9	60.7	63.6	60.3	49.9	48.1	39.7	35.5	24.7	55.3
	PWL(3)	76.6	76.6	78.1	79.1	78.1	75.6	72.1	68.1	63.1	80.5
6SOA/W	SPL(1)	58.8	53.3	58.0	57.6	50.6	43.4	40.9	35.2	23.2	52.9
	SPL(2)	59.1	55.4	57.9	57.4	51.3	43.7	41.0	34.8	24.1	53.0
	PWL(3)	70.7	70.7	72.2	73.2	72.2	69.7	66.2	66.2	7.2	75.0
6LOA/W	SPL(1)	60.1	53.8	59.2	58.7	51.8	44.7	42.6	37.9	33.3	54.1
	SPL(2)	60.0	54.5	59.1	58.9	52.1	45.1	42.3	36.0	25.7	54.2
	PWL(3)	71.1	71.1	72.6	73.6	72.6	70.1	66.6	62.6	57.6	75.0
6LOC	SPL(1)	60.1	53.8	59.2	58.7	51.8	44.7	42.6	37.9	33.3	54.1
	PWL(4)	71.1	71.1	72.6	73.6	72.6	70.1	66.6	62.6	57.6	75.0
7SOA/W	SPL(1)	61.8	56.3	61.0	60.6	53.6	46.4	43.9	38.2	26.2	55.9
	SPL(2)	62.1	58.4	60.9	60.4	54.3	46.7	44.0	37.8	27.1	56.0
	PWL(3)	73.7	73.7	75.2	76.2	75.2	72.7	69.2	69.2	10.2	78.0
7LOA/W	SPL(1)	63.1	56.8	62.2	61.7	54.8	47.7	45.6	40.9	36.3	57.1
	SPL(2)	63.0	57.5	62.1	61.9	55.1	48.1	45.3	39.0	28.7	57.2
	PWL(3)	74.1	74.1	75.6	76.6	75.6	73.1	69.6	65.6	60.6	78.0
8SOA/W	SPL(1)	59.7	54.2	58.9	58.5	51.5	44.3	41.8	36.1	24.1	53.8
	SPL(2)	59.9	56.2	58.7	58.2	52.1	44.5	41.8	35.6	24.9	53.8
	PWL(3)	73.1	73.1	74.6	75.6	74.6	72.1	68.6	64.6	59.6	77.0
8LOA/W	SPL(1)	61.1	54.8	60.2	59.7	52.8	45.7	43.6	38.9	34.3	55.1
	SPL(2)	61.1	55.6	60.2	60.0	53.2	46.2	43.4	37.1	26.8	55.3
	PWL(3)	74.3	74.3	75.8	76.8	75.8	73.3	69.8	65.8	60.8	78.2
8LOC	SPL(1)	61.1	54.8	60.2	59.7	52.8	45.7	43.6	38.9	34.3	55.1
	PWL(4)	74.3	74.3	75.8	76.8	75.8	73.3	69.8	65.8	60.8	78.2
9SOA/W	SPL(1)	62.7	57.2	61.9	61.5	54.5	47.3	44.8	39.1	27.1	56.8
	SPL(2)	62.9	59.2	61.7	61.2	55.1	47.5	44.8	38.6	27.9	56.8
	PWL(3)	76.1	76.1	77.6	78.6	77.6	75.1	71.6	67.6	62.6	80.0
9LOA/W	SPL(1)	64.1	57.8	63.2	62.7	55.8	48.7	46.6	41.9	37.3	58.1
	SPL(2)	64.1	58.6	63.2	63.0	56.2	49.2	46.4	40.1	29.8	58.3
	PWL(3)	77.3	77.3	78.8	79.8	78.8	76.3	72.8	68.8	63.8	81.2
8LOD/H/F	SPL(1)	60.6	54.3	59.7	59.2	52.3	45.2	43.1	38.4	33.8	54.6
	SPL(2)	60.6	55.1	59.7	59.5	52.7	45.7	42.9	36.6	26.3	54.8
	PWL(3)	73.8	73.8	75.3	76.3	75.3	72.8	69.3	65.3	60.3	77.7
9LOD/H/F	SPL(1)	63.6	57.3	62.7	62.2	55.3	48.2	46.1	41.4	36.8	57.6
	SPL(2)	63.6	58.1	62.7	62.5	55.7	48.7	45.9	39.6	29.3	57.8
	PWL(3)	76.8	76.8	78.3	79.3	78.3	75.8	72.3	68.3	63.3	80.7

NOTES:

- (1) Only ventilation (20 Pa back pressure), 2 m in front of the unit and 1 m height, in free field conditions.
- (2) Working compressor (20 Pa back pressure), 2 m in front of the unit and 1 m height, in free field conditions.
- (3) Working compressor, on air delivery.
- (4) Only ventilation, on air delivery.

The sound pressure levels for each octave band are expressed in dB with tolerances of (–0/+2) dB.

Version OVER – 60 HZ

Model	Mode	octave band frequency (Hz)									Sound Level [dB(A)]
		31.5	63	125	250	500	1000	2000	4000	8000	
4MOA	SPL(1)	51.0	49.3	52.6	48.9	39.4	36.3	28.3	23.7	11.8	44.0
	SPL(2)	50.9	48.9	52.6	48.1	39.4	36.3	27.4	22.7	11.8	43.6
	PWL(3)	61.0	61.2	63.5	63.3	64.0	60.2	56.2	51.7	46.6	65.3
4SOA/W	SPL(1)	57.3	55.8	58.2	54.3	44.0	43.4	35.9	32.5	22.5	49.8
	SPL(2)	57.2	55.4	58.2	53.5	44.0	43.4	35.0	31.5	22.5	49.4
	PWL(3)	67.3	67.7	69.1	68.7	68.6	67.3	63.8	60.5	57.3	71.8
4LOA/W	SPL(1)	58.3	57.5	60.1	56.9	46.0	44.3	35.7	31.7	20.9	51.7
	SPL(2)	58.3	57.5	60.1	56.9	46.0	44.3	35.7	31.7	20.9	51.7
	PWL(3)	73.0	73.4	74.6	75.7	74.2	71.8	68.1	64.3	59.3	76.6
4LOC	SPL(1)	58.3	57.5	60.1	56.9	46.0	44.3	35.7	31.7	20.9	51.7
	PWL(4)	73.0	73.4	74.6	75.7	74.2	71.8	68.1	64.3	59.3	76.6
5SOA/W	SPL(1)	60.3	58.8	61.2	57.3	47.0	46.4	38.9	35.5	25.5	52.8
	SPL(2)	60.2	58.4	61.2	56.5	47.0	46.4	38.0	34.5	25.5	52.4
	PWL(3)	70.3	70.7	72.1	71.7	71.6	70.3	66.8	63.5	60.3	74.8
5LOA/W	SPL(1)	61.3	60.5	63.1	59.9	49.0	47.3	38.7	34.7	23.9	54.7
	SPL(2)	61.3	60.5	63.1	59.9	49.0	47.3	38.7	34.7	23.9	54.7
	PWL(3)	76.0	76.4	77.6	78.7	77.2	74.8	71.1	67.3	62.3	79.6
6SOA/W	SPL(1)	61.8	53.8	63.6	59.1	51.1	44.9	42.2	36.6	25.0	54.6
	SPL(2)	62.1	55.9	63.5	58.9	51.8	45.2	42.3	36.2	25.9	54.7
	PWL(3)	73.7	71.2	77.8	74.7	72.7	71.2	67.5	67.6	9.0	76.3
6LOA/W	SPL(1)	64.4	55.6	73.2	61.5	53.6	46.8	45.6	41.1	37.4	59.7
	SPL(2)	64.3	56.3	73.1	61.7	53.9	47.2	45.3	39.2	29.8	59.7
	PWL(3)	75.4	72.9	86.6	76.4	74.4	72.2	69.6	65.8	61.7	78.1
6LOC	SPL(1)	64.4	55.6	73.2	61.5	53.6	46.8	45.6	41.1	37.4	59.7
	PWL(4)	75.4	72.9	86.6	76.4	74.4	72.2	69.6	65.8	61.7	78.1
7SOA/W	SPL(1)	64.8	56.8	66.6	62.1	54.1	47.9	45.2	39.6	28.0	57.6
	SPL(2)	65.1	58.9	66.5	61.9	54.8	48.2	45.3	39.2	28.9	57.7
	PWL(3)	76.7	74.2	80.8	77.7	75.7	74.2	70.5	70.6	12.0	79.3
7LOA/W	SPL(1)	67.4	58.6	76.2	64.5	56.6	49.8	48.6	44.1	40.4	62.7
	SPL(2)	67.3	59.3	76.1	64.7	56.9	50.2	48.3	42.2	32.8	62.7
	PWL(3)	78.4	75.9	89.6	79.4	77.4	75.2	72.6	68.8	64.7	81.1
8SOA/W	SPL(1)	50.8	47.0	56.5	55.0	49.3	41.2	38.5	32.4	19.5	50.8
	SPL(2)	51.0	49.0	56.3	54.7	49.9	41.4	38.5	31.9	20.3	50.9
	PWL(3)	64.2	65.9	72.2	72.1	72.4	69.0	65.3	60.9	55.0	74.0
8LOA/W	SPL(1)	72.5	55.0	59.9	60.3	53.5	46.2	44.2	39.5	35.2	55.7
	SPL(2)	72.5	55.8	59.9	60.6	53.9	46.7	44.0	37.7	27.7	55.9
	PWL(3)	85.7	74.5	75.5	77.4	76.5	73.8	70.4	66.4	61.7	78.8
8LOC	SPL(1)	72.5	55.0	59.9	60.3	53.5	46.2	44.2	39.5	35.2	55.7
	PWL(4)	85.7	74.5	75.5	77.4	76.5	73.8	70.4	66.4	61.7	78.8
9SOA/W	SPL(1)	53.8	50.0	59.5	58.0	52.3	44.2	41.5	35.4	22.5	53.8
	SPL(2)	54.0	52.0	59.3	57.7	52.9	44.4	41.5	34.9	23.3	53.9
	PWL(3)	67.2	68.9	75.2	75.1	75.4	72.0	68.3	63.9	58.0	77.0
9LOA/W	SPL(1)	75.5	58.0	62.9	63.3	56.5	49.2	47.2	42.5	38.2	58.7
	SPL(2)	75.5	58.8	62.9	63.6	56.9	49.7	47.0	40.7	30.7	58.9
	PWL(3)	88.7	77.5	78.5	80.4	79.5	76.8	73.4	69.4	64.7	81.8
8LOD/H/F	SPL(1)	72.0	54.5	59.4	59.8	53.0	45.7	43.7	39.0	34.7	55.2
	SPL(2)	72.0	55.3	59.4	60.1	53.4	46.2	43.5	37.2	27.2	55.4
	PWL(3)	85.2	74.0	75.0	76.9	76.0	73.3	69.9	65.9	61.2	78.3
9LOD/H/F	SPL(1)	75.0	57.5	62.4	62.8	56.0	48.7	46.7	42.0	37.7	58.2
	SPL(2)	75.0	58.3	62.4	63.1	56.4	49.2	46.5	40.2	30.2	58.4
	PWL(3)	88.2	77.0	78.0	79.9	79.0	76.3	72.9	68.9	64.2	81.3

NOTES:

- (1) Only ventilation (20 Pa back pressure), 2 m in front of the unit and 1 m height, in free field conditions.
- (2) Working compressor (20 Pa back pressure), 2 m in front of the unit and 1 m height, in free field conditions.
- (3) Working compressor, on air delivery.
- (4) Only ventilation, on air delivery.

The sound pressure levels for each octave band are expressed in dB with tolerances of (-0/+2) dB.

10 – Technical data and performances

Technical data and performances – air condensation – xxUA series, downward flow – 50Hz

MODEL		4PUA	4GUA	6PUA	6GUA	8PUA	8GUA
power supply voltage	V/ph/Hz	400/3/50	400/3/50	400/3/50	400/3/50	400/3/50	400/3/50
PERFORMANCES (1)							
air flow	m ³ /s	0.46	0.64	0.74	0.80	1.21	1.31
available head	Pa	20	20	20	20	20	20
total cooling capacity	kW	5.6	8.3	10.2	12.2	13.4	16.3
sensible cooling capacity	kW	5.0	7.2	9.1	10.8	13.4	15.2
full absorbed power (fan and compressor)	kW	1.8	2.7	2.9	3.6	4.0	5.0
compressor absorbed power	kW	1.5	2.2	2.5	3.1	3.1	3.8
compressor absorbed current	A	6.8	4.2	4.8	6.0	6.0	7.6
fan absorbed power	kW	0.3	0.6	0.4	0.5	0.9	1.2
fan absorbed current	A	1.4	2.6	2.6	3.3	4.5	5.4
SHR (Sensible Heat Ratio)	–	0.90	0.87	0.89	0.88	1.00	0.93
EER (Energy Efficiency Ratio)	–	3.12	3.07	3.55	3.45	3.33	3.23
SPL (Sound Pressure Level) (2)	dB(A)	46.9	50.1	50.0	51.3	50.3	52.6
FANS							
quantity	no.	1	1	1	1	1	1
type		dd 9/9	dd 9/9	dd 10/10	dd 10/10	dd 12/12	dd 12/12
speed	no.	3	3	3	3	3	3
motor rated power	kW	0.245	0.420	0.500	0.500	0.736	0.736
poles	no.	6	4	6	6	6	6
COMPRESSOR							
quantity	no.	1	1	1	1	1	1
type		scroll					
rated power for single compressor	HP	1.90	2.50	3.25	4.00	4.00	5.00
refrigerant		R407C	R407C	R407C	R407C	R407C	R407C
EVAPORATING COIL							
quantity	no.	1	1	1	1	1	1
pipes/fins		copper/aluminium		copper/treated aluminium			
fins for inch/rows	no.	12/3	12/3	12/4	12/4	12/5	12/5
front surface	m ²	0.33	0.33	0.50	0.50	0.50	0.50
position		inclined					
REFRIGERANT CONNECTIONS							
gas line (pipe to be welded, o.d.)	mm	14	14	16	16	16	16
liquid line (pipe to be welded, o.d.)	mm	12	12	14	14	14	14
recommended diam. for refrigerant lines to the condenser (o.d.) Gas – Liquid	mm	10–10	12–12	12–12	14–14	14–14	16–16
DIMENSIONS							
length	mm	750	750	750	750	750	750
depth	mm	450	450	600	600	750	750
height	mm	1950	1950	1950	1950	1950	1950
plan surface	m ²	0.34	0.34	0.45	0.45	0.56	0.56
WEIGHTS							
net	kg	180	195	205	220	280	295
gross	kg	190	205	215	230	290	305

1 ON THE FOLLOWING STANDARD CONDITIONS: standard supply [voltage \pm 10%]; room conditions 24°C bs; 50% R.H. (17°C bu) – condensation temperature: 45°C

2 Measured in the front part at 1 m height, 2 m distance, referred to free field, with working fans and compressor.

ATTENTION: the refrigerating outputs are meant after deduction of the heat taken from the fans, which must thus be added to the room load. The EER refers only to the room unit. The unit air flow refers in standard configuration with clean class filter G3. The standard diameters of the pipings are valid only for lengths – between the conditioner and the condensing unit – up to 30 equivalent m.

Technical data and performances – air condensation – xxUA series, downward flow – 50Hz

MODEL		5PUA	5GUA	7PUA	7GUA	9PUA	9GUA
power supply voltage	V/ph/Hz	400/3/50	400/3/50	400/3/50	400/3/50	400/3/50	400/3/50
PERFORMANCES (1)							
air flow	m ³ /s	0.92	1.28	1.48	1.60	2.42	2.62
available head	Pa	20	20	20	20	20	20
total cooling capacity	kW	11.2	16.6	20.4	24.4	26.8	32.6
sensible cooling capacity	kW	10.0	14.4	18.2	21.6	26.8	30.4
full absorbed power (fans and compressors)	kW	3.6	5.4	5.8	7.2	8.0	10.0
compressor absorbed power	kW	3.0	4.4	5.0	6.2	6.2	7.6
each compressor absorbed current	A	6.8	4.2	4.8	6.0	6.0	7.6
fan absorbed power	kW	0.6	1.2	0.8	1.0	1.8	2.4
each fan absorbed current	A	1.4	2.6	2.6	3.3	4.5	5.4
SHR (Sensible Heat Ratio)	–	0.90	0.87	0.89	0.88	1.00	0.93
EER (Energy Efficiency Ratio)	–	3.12	3.07	3.55	3.45	3.33	3.23
SPL (Sound Pressure Level) (2)	dB(A)	49.9	53.1	53.0	54.3	53.3	55.6
FANS							
quantity	no.	2	2	2	2	2	2
type		dd 9/9	dd 9/9	dd 10/10	dd 10/10	dd 12/12	dd 12/12
speed	no.	3	3	3	3	3	3
motor rated power	kW	0.245	0.420	0.500	0.500	0.736	0.736
poles	no.	6	4	6	6	6	6
COMPRESSOR							
quantity	no.	2	2	2	2	2	2
type		scroll					
rated power for single compressor	HP	1.90	2.50	3.25	4.00	4.00	5.00
refrigerant		R407C	R407C	R407C	R407C	R407C	R407C
EVAPORATING COIL							
quantity	no.	2	2	2	2	2	2
pipes/fins		copper/aluminium		copper/treated aluminium			
fins for inch/rows	no.	12/3	12/3	12/4	12/4	12/5	12/5
front surface single coil	m ²	0.33	0.33	0.50	0.50	0.50	0.50
position		inclined					
REFRIGERANT CONNECTIONS							
gas line (pipe to be welded, o.d.)	mm	14	14	16	16	16	16
liquid line (pipe to be welded, o.d.)	mm	12	12	14	14	14	14
recommended diam. for refrigerant lines to the condenser (o.d.) Gas – Liquid	mm	10–10	12–12	12–12	14–14	14–14	16–16
DIMENSIONS							
length	mm	1490	1490	1490	1490	1490	1490
depth	mm	450	450	600	600	750	750
height	mm	1950	1950	1950	1950	1950	1950
plan surface	m ²	0.67	0.67	0.89	0.89	1.12	1.12
WEIGHTS							
net	kg	345	375	395	425	545	575
gross	kg	365	395	415	445	565	595

1 ON THE FOLLOWING STANDARD CONDITIONS: standard supply [voltage \pm 10%]; room conditions 24°C bs; 50% R.H. (17°C bu) – condensation temperature: 45°C

2 Measured in the front part at 1 m height, 2 m distance, referred to free field, with working fans and compressor.

ATTENTION: the refrigerating outputs are meant after deduction of the heat taken from the fans, which must thus be added to the room load. The EER refers only to the room unit. The unit air flow refers in standard configuration with clean class filter G3. The standard diameters of the pipings are valid only for lengths – between the conditioner and the condensing unit – up to 30 equivalent m.

Technical data and performances – air condensation – xxUA series, downward flow – 60Hz

MODEL		4PUA	4GUA	6PUA	6GUA	8PUA	8GUA
power supply voltage	V/ph/Hz	208– 230/1/60	200– 230/3/60	200– 230/3/60	380/3/60	380/3/60	380/3/60
PERFORMANCES (1)							
air flow	m ³ /s	0.55	0.64	0.81	0.90	1.12	1.37
available head	Pa	20	20	20	20	20	20
total cooling capacity	kW	6.7	9.6	12.0	14.5	15.6	19.1
sensible cooling capacity	kW	5.8	7.8	10.1	12.3	14.0	16.6
full absorbed power (fan and compressor)	kW	2.2	3.6	3.7	4.5	5.0	6.2
compressor absorbed power	kW	1.7	2.6	3.0	3.7	3.7	4.6
compressor absorbed current	A	6.8	7.3	8.3	6.0	6.0	7.6
fan absorbed power	kW	0.5	1.0	0.7	0.8	1.3	1.6
fan absorbed current	A	2.3	4.3	3.7	4.0	5.9	7.1
SHR (Sensible Heat Ratio)	–	0.87	0.81	0.84	0.85	0.90	0.87
EER (Energy Efficiency Ratio)	–	3.05	2.67	3.24	3.22	3.12	3.11
SPL (Sound Pressure Level) (2)	dB(A)	49.8	49.4	51.5	54.9	47.6	53.1
FANS							
quantity	no.	1	1	1	1	1	1
type		dd 9/9	dd 9/9	dd 10/10	dd 10/10	dd 12/12	dd 12/12
speed	no.	3	3	3	3	3	3
motor rated power	kW	0.245	0.420	0.500	0.500	0.736	0.736
poles	no.	6	4	6	6	6	6
COMPRESSOR							
quantity	no.	1	1	1	1	1	1
type		scroll					
rated power for single compressor	HP	1.90	2.50	3.25	4.00	4.00	5.00
refrigerant		R407C	R407C	R407C	R407C	R407C	R407C
EVAPORATING COIL							
quantity	no.	1	1	1	1	1	1
pipes/fins		copper/aluminium			copper/treated aluminium		
fins for inch/rows	no.	12/3	12/3	12/4	12/4	12/5	12/5
front surface	m ²	0.33	0.33	0.50	0.50	0.50	0.50
position		inclined					
REFRIGERANT CONNECTIONS							
gas line (pipe to be welded, o.d.)	mm	14	14	16	16	16	16
liquid line (pipe to be welded, o.d.)	mm	12	12	14	14	14	14
recommended diam. for refrigerant lines to the condenser (o.d.) Gas – Liquid	mm	10–10	12–12	12–12	14–14	14–14	16–16
DIMENSIONS							
length	mm	750	750	750	750	750	750
depth	mm	450	450	600	600	750	750
height	mm	1950	1950	1950	1950	1950	1950
plan surface	m ²	0.34	0.34	0.45	0.45	0.56	0.56
WEIGHTS							
net	kg	180	195	205	220	280	295
gross	kg	190	205	215	230	290	305

1 ON THE FOLLOWING STANDARD CONDITIONS: standard supply [voltage \pm 10%]; room conditions 24°C bs; 50% R.H. (17°C bu) – condensation temperature: 45°C

2 Measured in the front part at 1 m height, 2 m distance, referred to free field, with working fans and compressor.

ATTENTION: the refrigerating outputs are meant after deduction of the heat taken from the fans, which must thus be added to the room load. The EER refers only to the room unit. The unit air flow refers in standard configuration with clean class filter G3. The standard diameters of the pipings are valid only for lengths – between the conditioner and the condensing unit – up to 30 equivalent m.

Technical data and performances – air condensation – xxUA series, downward flow – 60Hz

MODEL		5PUA	5GUA	7PUA	7GUA	9PUA	9GUA
power supply voltage	V/ph/Hz	208– 230/1/60	200– 230/3/60	200– 230/3/60	380/3/60	380/3/60	380/3/60
PERFORMANCES (1)							
air flow	m ³ /s	1.10	1.28	1.62	1.80	2.24	2.74
available head	Pa	20	20	20	20	20	20
total cooling capacity	kW	13.4	19.2	24.0	29.0	31.2	38.2
sensible cooling capacity	kW	11.6	15.6	20.2	24.6	28.0	33.2
full absorbed power (fans and compressors)	kW	4.4	7.2	7.4	9.0	10.0	12.4
compressor absorbed power	kW	3.4	5.2	6.0	7.4	7.4	9.2
each compressor absorbed current	A	6.8	7.3	8.3	6.0	6.0	7.6
fan absorbed power	kW	1.0	2.0	1.4	1.6	2.6	3.2
each fan absorbed current	A	2.3	4.3	3.7	4.0	5.9	7.1
SHR (Sensible Heat Ratio)	–	0.87	0.81	0.84	0.85	0.90	0.87
EER (Energy Efficiency Ratio)	–	3.05	2.67	3.24	3.22	3.12	3.11
SPL (Sound Pressure Level) (2)	dB(A)	52.8	52.4	54.5	57.9	50.6	56.1
FANS							
quantity	no.	2	2	2	2	2	2
type		dd 9/9	dd 9/9	dd 10/10	dd 10/10	dd 12/12	dd 12/12
speed	no.	3	3	3	3	3	3
motor rated power	kW	0.245	0.420	0.500	0.500	0.736	0.736
poles	no.	6	4	6	6	6	6
COMPRESSOR							
quantity	no.	2	2	2	2	2	2
type		scroll					
rated power for single compressor	HP	1.90	2.50	3.25	4.00	4.00	5.00
refrigerant		R407C	R407C	R407C	R407C	R407C	R407C
EVAPORATING COIL							
quantity	no.	2	2	2	2	2	2
pipes/fins		copper/aluminium			copper/treated aluminium		
fins for inch/rows	no.	12/3	12/3	12/4	12/4	12/5	12/5
front surface single coil	m ²	0.33	0.33	0.50	0.50	0.50	0.50
position		inclined					
REFRIGERANT CONNECTIONS							
gas line (pipe to be welded, o.d.)	mm	14	14	16	16	16	16
liquid line (pipe to be welded, o.d.)	mm	12	12	14	14	14	14
recommended diam. for refrigerant lines to the condenser (o.d.) Gas – Liquid	mm	10–10	12–12	12–12	14–14	14–14	16–16
DIMENSIONS							
length	mm	1490	1490	1490	1490	1490	1490
depth	mm	450	450	600	600	750	750
height	mm	1950	1950	1950	1950	1950	1950
plan surface	m ²	0.67	0.67	0.89	0.89	1.12	1.12
WEIGHTS							
net	kg	345	375	395	425	545	575
gross	kg	365	395	415	445	565	595

1 ON THE FOLLOWING STANDARD CONDITIONS: standard supply [voltage \pm 10%]; room conditions 24°C bs; 50% R.H. (17°C bu) – condensation temperature: 45°C

2 Measured in the front part at 1 m height, 2 m distance, referred to free field, with working fans and compressor.

ATTENTION: the refrigerating outputs are meant after deduction of the heat taken from the fans, which must thus be added to the room load. The EER refers only to the room unit. The unit air flow refers in standard configuration with clean class filter G3. The standard diameters of the pipings are valid only for lengths – between the conditioner and the condensing unit – up to 30 equivalent m.

Technical data and performances – air condensation – xxUA series, downward flow – 50Hz

MODEL		4MUA	4SUA	4LUA	6SUA	6LUA	8SUA	8LUA
power supply voltage	V/ph/Hz	230/1/50	400/3/50	400/3/50	400/3/50	400/3/50	400/3/50	400/3/50
PERFORMANCES (1)								
air flow	m ³ /s	0.42	0.46	0.64	0.74	0.80	1.21	1.31
available head	Pa	20	20	20	20	20	20	20
total cooling capacity	kW	5.1	5.5	8.1	10.2	11.7	13.3	16.2
sensible cooling capacity	kW	4.9	5.0	7.1	9.1	10.6	13.3	15.3
full absorbed power (fan and compressor)	kW	1.7	1.7	2.6	2.8	3.4	3.8	4.9
compressor absorbed power	kW	1.4	1.4	2.0	2.5	2.9	2.9	3.6
compressor absorbed current	A	6.0	6.5	3.8	4.5	5.9	5.9	7.4
fan absorbed power	kW	0.3	0.3	0.6	0.4	0.5	0.9	1.2
fan absorbed current	A	1.2	1.4	2.6	2.6	3.3	4.5	5.4
SHR (Sensible Heat Ratio)	–	0.96	0.91	0.88	0.89	0.91	1.00	0.94
EER (Energy Efficiency Ratio)	–	3.05	3.22	3.13	3.59	3.46	3.47	3.34
SPL (Sound Pressure Level) (2)	dB(A)	44.9	46.9	50.1	50.0	51.3	50.3	52.6
FANS								
quantity	no.	1	1	1	1	1	1	1
type		dd 9/9	dd 9/9	dd 9/9	dd 10/10	dd 10/10	dd 12/12	dd 12/12
speed	no.	3	3	3	3	3	3	3
motor rated power	kW	0.147	0.245	0.420	0.500	0.500	0.736	0.736
poles	no.	6	6	4	6	6	6	6
COMPRESSOR								
quantity	no.	1	1	1	1	1	1	1
type		scroll						
rated power for single compressor	HP	1.40	1.90	2.50	3.25	4.00	4.00	5.00
refrigerant		R22	R22	R22	R22	R22	R22	R22
EVAPORATING COIL								
quantity	no.	1	1	1	1	1	1	1
pipes/fins		copper/aluminium			copper/treated aluminium			
fins for inch/rows	no.	12/3	12/3	12/3	12/4	12/4	12/5	12/5
front surface	m ²	0.33	0.33	0.33	0.50	0.50	0.50	0.50
position		inclined						
REFRIGERANT CONNECTIONS								
gas line (pipe to be welded, o.d.)	mm	16	16	16	16	16	16	16
liquid line (pipe to be welded, o.d.)	mm	16	16	16	16	16	16	16
recommended diam. for refrigerant lines to the condenser (o.d.) Gas – Liquid	mm	10–10	10–10	12–12	12–12	14–14	16–16	16–16
DIMENSIONS								
length	mm	750	750	750	750	750	750	750
depth	mm	450	450	450	600	600	750	750
height	mm	1950	1950	1950	1950	1950	1950	1950
plan surface	m ²	0.34	0.34	0.34	0.45	0.45	0.56	0.56
WEIGHTS								
net	kg	180	180	195	205	220	280	295
gross	kg	190	190	205	215	230	290	305

1 ON THE FOLLOWING STANDARD CONDITIONS: standard supply [voltage \pm 10%]; room conditions 24°C bs; 50% R.H. (17°C bu) – condensation temperature: 45°C

2 Measured in the front part at 1 m height, 2 m distance, referred to free field, with working fans and compressor.

ATTENTION: the refrigerating outputs are meant after deduction of the heat taken from the fans, which must thus be added to the room load. The EER refers only to the room unit. The unit air flow refers in standard configuration with clean class filter G3. The standard diameters of the pipings are valid only for lengths – between the conditioner and the condensing unit – up to 30 equivalent m.

Technical data and performances – air condensation – xxUA series, downward flow – 50Hz

MODEL		5SUA	5LUA	7SUA	7LUA	9SUA	9LUA
power supply voltage	V/ph/Hz	400/3/50	400/3/50	400/3/50	400/3/50	400/3/50	400/3/50
PERFORMANCES (1)							
air flow	m ³ /s	0.92	1.28	1.49	1.60	2.42	2.62
available head	Pa	20	20	20	20	20	20
total cooling capacity	kW	11.0	16.2	20.4	23.4	26.6	32.4
sensible cooling capacity	kW	10.0	14.2	18.2	21.2	26.6	30.6
full absorbed power (fans and compressors)	kW	3.4	5.2	5.6	6.8	7.6	9.8
compressor absorbed power	kW	2.8	4.0	5.0	5.8	5.8	7.2
each compressor absorbed current	A	6.5	3.8	4.5	5.9	5.9	7.4
fan absorbed power	kW	0.6	1.2	0.8	1.0	1.8	2.4
each fan absorbed current	A	1.4	2.6	2.6	3.3	4.5	5.4
SHR (Sensible Heat Ratio)	–	0.91	0.88	0.89	0.91	1.00	0.94
EER (Energy Efficiency Ratio)	–	3.22	3.13	3.59	3.46	3.47	3.34
SPL (Sound Pressure Level) (2)	dB(A)	49.9	53.1	53.0	54.3	53.3	55.6
FANS							
quantity	no.	2	2	2	2	2	2
type		dd 9/9	dd 9/9	dd 10/10	dd 10/10	dd 12/12	dd 12/12
speed	no.	3	3	3	3	3	3
motor rated power	kW	0.245	0.420	0.500	0.500	0.736	0.736
poles	no.	6	4	6	6	6	6
COMPRESSORS							
quantity	no.	2	2	2	2	2	2
type		scroll					
rated power for single compressor	HP	1.90	2.50	3.25	4.00	4.00	5.00
refrigerant		R22	R22	R22	R22	R22	R22
EVAPORATING COIL							
quantity	no.	2	2	2	2	2	2
pipes/fins		copper/aluminium		copper/treated aluminium			
fins for inch/rows	no.	12/3	12/3	12/4	12/4	12/5	12/5
front surface single coil	m ²	0.33	0.33	0.50	0.50	0.50	0.50
position		inclined					
REFRIGERANT CONNECTIONS							
gas line (pipe to be welded, o.d.)	mm	16	16	16	16	16	16
liquid line (pipe to be welded, o.d.)	mm	16	16	16	16	16	16
recommended diam. for refrigerant lines to the condenser (o.d.) Gas – Liquid	mm	10–10	12–12	12–12	14–14	16–16	16–16
DIMENSIONS							
length	mm	1490	1490	1490	1490	1490	1490
depth	mm	450	450	600	600	750	750
height	mm	1950	1950	1950	1950	1950	1950
plan surface	m ²	0.67	0.67	0.89	0.89	1.12	1.12
WEIGHTS							
net	kg	345	375	395	425	545	575
gross	kg	365	395	415	445	565	595

1 ON THE FOLLOWING STANDARD CONDITIONS: standard supply [voltage $\pm 10\%$]; room conditions 24°C bs; 50% R.H. (17°C bu) – condensation temperature: 45°C

2 Measured in the front part at 1 m height, 2 m distance, referred to free field, with working fans and compressor.

ATTENTION: the refrigerating outputs are meant after deduction of the heat taken from the fans, which must thus be added to the room load. The EER refers only to the room unit. The unit air flow refers in standard configuration with clean class filter G3. The standard diameters of the pipings are valid only for lengths – between the conditioner and the condensing unit – up to 30 equivalent m.

Technical data and performances – air condensation – xxUA series, downward flow – 60Hz

Dati tecnici e prestazioni, condensazione ad aria – serie xxUA, mandata verso il basso – 60Hz

MODEL		4MUA	4SUA	4LUA	6SUA	6LUA	8SUA	8LUA
power supply voltage	V/ph/Hz	230/1/60	208– 230/1/60	200– 230/3/60	200– 230/3/60	380/3/60	380/3/60	380/3/60
PERFORMANCES (1)								
air flow	m ³ /s	0.42	0.55	0.64	0.81	0.90	1.12	1.37
available head	Pa	20	20	20	20	20	20	20
total cooling capacity	kW	5.7	6.5	9.4	12.0	14.0	15.5	19.1
sensible cooling capacity	kW	5.1	5.8	7.7	10.1	12.1	13.9	16.7
full absorbed power (fan and compressor)	kW	2.0	2.2	3.5	3.7	4.3	4.8	5.9
compressor absorbed power	kW	1.7	1.7	2.5	3.0	3.5	3.5	4.3
compressor absorbed current	A	6.0	6.5	6.6	7.8	5.9	5.9	7.4
fan absorbed power	kW	0.3	0.5	1.0	0.7	0.8	1.3	1.6
fan absorbed current	A	1.5	2.3	4.3	3.7	4.0	5.9	7.1
SHR (Sensible Heat Ratio)	–	0.91	0.89	0.82	0.84	0.86	0.90	0.88
EER (Energy Efficiency Ratio)	–	2.82	2.95	2.69	3.24	3.26	3.23	3.21
SPL (Sound Pressure Level) (2)	dB(A)	43.6	49.8	49.4	51.5	54.9	47.6	53.1
FANS								
quantity	no.	1	1	1	1	1	1	1
type		dd 9/9	dd 9/9	dd 9/9	dd 10/10	dd 10/10	dd 12/12	dd 12/12
speed	no.	3	3	3	3	3	3	3
motor rated power	kW	0.147	0.245	0.420	0.500	0.500	0.736	0.736
poles	no.	6	6	4	6	6	6	6
COMPRESSOR								
quantity	no.	1	1	1	1	1	1	1
type		scroll						
rated power for single compressor	HP	1.70	1.90	2.50	3.25	4.00	4.00	5.00
refrigerant		R22	R22	R22	R22	R22	R22	R22
EVAPORATING COIL								
quantity	no.	1	1	1	1	1	1	1
pipes/fins		copper/aluminium			copper/treated aluminium			
fins for inch/rows	no.	12/3	12/3	12/3	12/4	12/4	12/5	12/5
front surface	m ²	0.33	0.33	0.33	0.50	0.50	0.50	0.50
position		inclined						
REFRIGERANT CONNECTIONS								
gas line (pipe to be welded, o.d.)	mm	16	16	16	16	16	16	16
liquid line (pipe to be welded, o.d.)	mm	16	16	16	16	16	16	16
recommended diam. for refrigerant lines to the condenser (o.d.) Gas – Liquid	mm	10–10	10–10	12–12	12–12	14–14	16–16	16–16
DIMENSIONS								
length	mm	750	750	750	750	750	750	750
depth	mm	450	450	450	600	600	750	750
height	mm	1950	1950	1950	1950	1950	1950	1950
plan surface	m ²	0.34	0.34	0.34	0.45	0.45	0.56	0.56
WEIGHTS								
net	kg	180	180	195	205	220	280	295
gross	kg	190	190	205	215	230	290	305

1 ON THE FOLLOWING STANDARD CONDITIONS: standard supply [voltage \pm 10%]; room conditions 24°C bs; 50% R.H. (17°C bu) – condensation temperature: 45°C

2 Measured in the front part at 1 m height, 2 m distance, referred to free field, with working fans and compressor.

ATTENTION: the refrigerating outputs are meant after deduction of the heat taken from the fans, which must thus be added to the room load. The EER refers only to the room unit. The unit air flow refers in standard configuration with clean class filter G3. The standard diameters of the pipings are valid only for lengths – between the conditioner and the condensing unit – up to 30 equivalent m.

Technical data and performances – air condensation – xxUA series, downward flow – 60Hz

Dati tecnici e prestazioni, condensazione ad aria – serie xxUA, mandata verso il basso – 60Hz

MODEL		5SUA	5LUA	7SUA	7LUA	9SUA	9LUA
power supply voltage	V/ph/Hz	208– 230/1/60	200– 230/3/60	200– 230/3/60	380/3/60	380/3/60	380/3/60
PERFORMANCES (1)							
air flow	m ³ /s	1.10	1.28	1.62	1.80	2.24	2.74
available head	Pa	20	20	20	20	20	20
total cooling capacity	kW	13.0	18.8	24.0	28.0	31.0	38.2
sensible cooling capacity	kW	11.6	15.4	20.2	24.2	27.8	33.4
full absorbed power (fans and compressors)	kW	4.4	7.0	7.4	8.6	9.6	11.8
compressor absorbed power	kW	3.4	5.0	6.0	7.0	7.0	8.6
each compressor absorbed current	A	6.5	6.6	7.8	5.9	5.9	7.4
fan absorbed power	kW	1.0	2.0	1.4	1.6	2.6	3.2
each fan absorbed current	A	2.3	4.3	3.7	4.0	5.9	7.1
SHR (Sensible Heat Ratio)	–	0.89	0.82	0.84	0.86	0.90	0.88
EER (Energy Efficiency Ratio)	–	2.95	2.69	3.24	3.26	3.23	3.21
SPL (Sound Pressure Level) (2)	dB(A)	52.8	52.4	54.5	57.9	50.6	56.1
FANS							
quantity	no.	2	2	2	2	2	2
type		dd 9/9	dd 9/9	dd 10/10	dd 10/10	dd 12/12	dd 12/12
speed	no.	3	3	3	3	3	3
motor rated power	kW	0.245	0.420	0.500	0.500	0.736	0.736
poles	no.	6	4	6	6	6	6
COMPRESSORS							
quantity	no.	2	2	2	2	2	2
type		scroll					
rated power for single compressor	HP	1.90	2.50	3.25	4.00	4.00	5.00
refrigerant		R22	R22	R22	R22	R22	R22
EVAPORATING COIL							
quantity	no.	2	2	2	2	2	2
pipes/fins		copper/aluminium		copper/treated aluminium			
fins for inch/rows	no.	12/3	12/3	12/4	12/4	12/5	12/5
front surface single coil	m ²	0.33	0.33	0.50	0.50	0.50	0.50
position		inclined					
REFRIGERANT CONNECTIONS							
gas line (pipe to be welded, o.d.)	mm	16	16	16	16	16	16
liquid line (pipe to be welded, o.d.)	mm	16	16	16	16	16	16
recommended diam. for refrigerant lines to the condenser (o.d.) Gas – Liquid	mm	10–10	12–12	12–12	14–14	16–16	16–16
DIMENSIONS							
length	mm	1490	1490	1490	1490	1490	1490
depth	mm	450	450	600	600	750	750
height	mm	1950	1950	1950	1950	1950	1950
plan surface	m ²	0.67	0.67	0.89	0.89	1.12	1.12
WEIGHTS							
net	kg	345	375	395	425	545	575
gross	kg	365	395	415	445	565	595

1 ON THE FOLLOWING STANDARD CONDITIONS: standard supply [voltage \pm 10%]; room conditions 24°C bs; 50% R.H. (17°C bu) – condensation temperature: 45°C

2 Measured in the front part at 1 m height, 2 m distance, referred to free field, with working fans and compressor.

ATTENTION: the refrigerating outputs are meant after deduction of the heat taken from the fans, which must thus be added to the room load. The EER refers only to the room unit. The unit air flow refers in standard configuration with clean class filter G3. The standard diameters of the pipings are valid only for lengths – between the conditioner and the condensing unit – up to 30 equivalent m.

Technical data and performances – air condensation – xxOA series, upward flow – 50Hz

MODEL		4POA	4GOA	6POA	6GOA	8POA	8GOA
power supply voltage	V/ph/Hz	400/3/50	400/3/50	400/3/50	400/3/50	400/3/50	400/3/50
PERFORMANCES (1)							
air flow	m ³ /s	0.40	0.59	0.68	0.73	1.08	1.13
available head	Pa	50	50	50	50	50	50
total cooling capacity	kW	5.3	8.0	10.0	11.9	13.1	15.8
sensible cooling capacity	kW	4.7	6.9	8.9	10.2	12.7	14.1
full absorbed power (fan and compressor)	kW	1.8	2.7	2.9	3.6	3.9	4.9
compressor absorbed power	kW	1.5	2.2	2.5	3.1	3.1	3.8
compressor absorbed current	A	6.8	4.2	4.8	6.0	6.0	7.6
fan absorbed power	kW	0.3	0.5	0.3	0.5	0.8	1.1
fan absorbed current	A	1.2	2.5	2.2	3.1	3.9	4.7
SHR (Sensible Heat Ratio)	–	0.89	0.86	0.89	0.86	0.97	0.89
EER (Energy Efficiency Ratio)	–	2.99	3.01	3.51	3.30	3.34	3.22
SPL (Sound Pressure Level) (2)	dB(A)	47.0	52.3	53.0	54.2	53.8	55.3
FANS							
quantity	no.	1	1	1	1	1	1
type		dd 9/9	dd 9/9	dd 10/10	dd 10/10	dd 12/12	dd 12/12
speed	no.	3	3	3	3	3	3
motor rated power	kW	0.245	0.420	0.500	0.500	0.736	0.736
poles	no.	6	4	6	6	6	6
COMPRESSOR							
quantity	no.	1	1	1	1	1	1
type		scroll					
rated power for single compressor	HP	1.90	2.50	3.25	4.00	4.00	5.00
refrigerant		R407C	R407C	R407C	R407C	R407C	R407C
EVAPORATING COIL							
quantity	no.	1	1	1	1	1	1
pipes/fins		copper/aluminium			copper/treated aluminium		
fins for inch/rows	no.	12/3	12/3	12/4	12/4	12/5	12/5
front surface	m ²	0.33	0.33	0.50	0.50	0.50	0.50
position		inclined					
REFRIGERANT CONNECTIONS							
gas line (pipe to be welded, o.d.)	mm	12	14	14	16	16	16
liquid line (pipe to be welded, o.d.)	mm	12	12	12	14	14	14
recommended diam. for refrigerant lines to the condenser (o.d.) Gas – Liquid	mm	10–10	12–12	12–12	14–14	14–14	16–16
DIMENSIONS							
length	mm	750	750	750	750	750	750
depth	mm	450	450	600	600	750	750
height	mm	1950	1950	1950	1950	1950	1950
plan surface	m ²	0.34	0.34	0.45	0.45	0.56	0.56
WEIGHTS							
net	kg	180	195	205	220	280	295
gross	kg	190	205	215	230	290	305

1 ON THE FOLLOWING STANDARD CONDITIONS: standard supply [voltage \pm 10%]; room conditions 24°C bs; 50% R.H. (17°C bu) – condensation temperature: 45°C

2 Measured in the front part at 1 m height, 2 m distance, referred to free field, with working fans and compressor.

ATTENTION: the refrigerating outputs are meant after deduction of the heat taken from the fans, which must thus be added to the room load. The EER refers only to the room unit. The unit air flow refers in standard configuration with clean class filter G3. The standard diameters of the pipings are valid only for lengths – between the conditioner and the condensing unit – up to 30 equivalent m.

Technical data and performances – air condensation – xxOA series, upward flow – 50Hz

MODEL		5POA	5GOA	7POA	7GOA	9POA	9GOA
power supply voltage	V/ph/Hz	400/3/50	400/3/50	400/3/50	400/3/50	400/3/50	400/3/50
PERFORMANCES (1)							
air flow	m ³ /s	0.80	1.18	1.36	1.46	2.16	2.26
available head	Pa	50	50	50	50	50	50
total cooling capacity	kW	10.6	16.0	20.0	23.8	26.2	31.6
sensible cooling capacity	kW	9.4	13.8	17.8	20.4	25.4	28.2
full absorbed power (fans and compressors)	kW	3.6	5.4	5.8	7.2	7.8	9.8
compressor absorbed power	kW	3.0	4.4	5.0	6.2	6.2	7.6
each compressor absorbed current	A	6.8	4.2	4.8	6.0	6.0	7.6
each fan absorbed current	kW	0.6	1.0	0.6	1.0	1.6	2.2
each fan absorbed current	A	1.2	2.5	2.2	3.1	3.9	4.7
SHR (Sensible Heat Ratio)	–	0.89	0.86	0.89	0.86	0.97	0.89
EER (Energy Efficiency Ratio)	–	2.99	3.01	3.51	3.30	3.34	3.22
SPL (Sound Pressure Level) (2)	dB(A)	50.0	55.3	56.0	57.2	56.8	58.3
FANS							
quantity	no.	2	2	2	2	2	2
type		dd 9/9	dd 9/9	dd 10/10	dd 10/10	dd 12/12	dd 12/12
speed	no.	3	3	3	3	3	3
motor rated power	kW	0.245	0.420	0.500	0.500	0.736	0.736
poles	no.	6	4	6	6	6	6
COMPRESSOR							
quantity	no.	2	2	2	2	2	2
type		scroll					
rated power for single compressor	HP	1.90	2.50	3.25	4.00	4.00	5.00
refrigerant		R407C	R407C	R407C	R407C	R407C	R407C
EVAPORATING COIL							
quantity	no.	2	2	2	2	2	2
pipes/fins		copper/aluminium			copper/treated aluminium		
fins for inch/rows	no.	12/3	12/3	12/4	12/4	12/5	12/5
front surface single coil	m ²	0.33	0.33	0.50	0.50	0.50	0.50
position		inclined					
REFRIGERANT CONNECTIONS							
gas line (pipe to be welded, o.d.)	mm	12	14	14	16	16	16
liquid line (pipe to be welded, o.d.)	mm	12	12	12	14	14	14
recommended diam. for refrigerant lines to the condenser (o.d.) Gas – Liquid	mm	10–10	12–12	12–12	14–14	14–14	16–16
DIMENSIONS							
length	mm	1490	1490	1490	1490	1490	1490
depth	mm	450	450	600	600	750	750
height	mm	1950	1950	1950	1950	1950	1950
plan surface	m ²	0.67	0.67	0.89	0.89	1.12	1.12
WEIGHTS							
net	kg	345	375	395	425	545	575
gross	kg	365	395	415	445	565	595

1 ON THE FOLLOWING STANDARD CONDITIONS: standard supply [voltage \pm 10%]; room conditions 24°C bs; 50% R.H. (17°C bu) – condensation temperature: 45°C

2 Measured in the front part at 1 m height, 2 m distance, referred to free field, with working fans and compressor.

ATTENTION: the refrigerating outputs are meant after deduction of the heat taken from the fans, which must thus be added to the room load. The EER refers only to the room unit. The unit air flow refers in standard configuration with clean class filter G3. The standard diameters of the pipings are valid only for lengths – between the conditioner and the condensing unit – up to 30 equivalent m.

Technical data and performances – air condensation–xxOA series, upward flow – 60Hz

MODEL		4POA	4GOA	6POA	6GOA	8POA	8GOA
power supply voltage	V/ph/Hz	208–230/ 1/60	200–230/ 3/60	200–230/ 3/60	380/3/60	380/3/60	380/3/60
PERFORMANCES (1)							
air flow	m ³ /s	0.50	0.61	0.77	0.85	1.05	1.28
available head	Pa	50	50	50	50	50	50
total cooling capacity	kW	6.4	9.3	11.9	14.1	15.3	18.7
sensible cooling capacity	kW	5.6	7.6	10.2	11.8	13.4	16.1
full absorbed power (fan and compressor)	kW	2.3	3.6	3.7	4.5	4.8	6.0
compressor absorbed power	kW	1.8	2.6	3.0	3.7	3.7	4.6
compressor absorbed current	A	6.8	7.3	8.3	6.0	6.0	7.6
fan absorbed power	kW	0.5	1.0	0.7	0.8	1.1	1.4
fan absorbed current	A	2.1	4.1	3.3	3.7	5.1	6.2
SHR (Sensible Heat Ratio)	–	0.87	0.81	0.86	0.84	0.87	0.86
EER (Energy Efficiency Ratio)	–	2.83	2.59	3.19	3.12	3.17	3.12
SPL (Sound Pressure Level) (2)	dB(A)	49.4	51.7	54.7	59.7	50.9	55.9
FANS							
quantity	no.	1	1	1	1	1	1
type		dd 9/9	dd 9/9	dd 10/10	dd 10/10	dd 12/12	dd 12/12
speed	no.	3	3	3	3	3	3
motor rated power	kW	0.245	0.420	0.500	0.500	0.736	0.736
poles	no.	6	4	6	6	6	6
COMPRESSOR							
quantity	no.	1	1	1	1	1	1
type		scroll					
rated power for single compressor	HP	1.90	2.50	3.25	4.00	4.00	5.00
refrigerant		R407C	R407C	R407C	R407C	R407C	R407C
EVAPORATING COIL							
quantity	no.	1	1	1	1	1	1
pipes/fins		copper/aluminium			copper/treated aluminium		
fins for inch/rows	no.	12/3	12/3	12/4	12/4	12/5	12/5
front surface	m ²	0.33	0.33	0.50	0.50	0.50	0.50
position		inclined					
REFRIGERANT CONNECTIONS							
gas line (pipe to be welded, o.d.)	mm	12	14	14	16	16	16
liquid line (pipe to be welded, o.d.)	mm	12	12	12	14	14	14
recommended diam. for refrigerant lines to the condenser (o.d.) Gas – Liquid	mm	10–10	12–12	12–12	14–14	14–14	16–16
DIMENSIONS							
length	mm	750	750	750	750	750	750
depth	mm	450	450	600	600	750	750
height	mm	1950	1950	1950	1950	1950	1950
plan surface	m ²	0.34	0.34	0.45	0.45	0.56	0.56
WEIGHTS							
net	kg	180	195	205	220	280	295
gross	kg	190	205	215	230	290	305

1 ON THE FOLLOWING STANDARD CONDITIONS: standard supply [voltage \pm 10%]; room conditions 24°C bs; 50% R.H. (17°C bu) – condensation temperature: 45°C

2 Measured in the front part at 1 m height, 2 m distance, referred to free field, with working fans and compressor.

ATTENTION: the refrigerating outputs are meant after deduction of the heat taken from the fans, which must thus be added to the room load. The EER refers only to the room unit. The unit air flow refers in standard configuration with clean class filter G3. The standard diameters of the pipings are valid only for lengths – between the conditioner and the condensing unit – up to 30 equivalent m.

Technical data and performances – air condensation–xxOA series, upward flow – 60Hz

MODEL		5POA	5GOA	7POA	7GOA	9POA	9GOA
power supply voltage	V/ph/Hz	208–230 /1/60	200–230 /3/60	200–230 /3/60	380/3/60	380/3/60	380/3/60
PERFORMANCES (1)							
air flow	m ³ /s	1.00	1.22	1.54	1.70	2.10	2.56
available head	Pa	50	50	50	50	50	50
total cooling capacity	kW	12.8	18.6	23.8	28.2	30.6	37.4
sensible cooling capacity	kW	11.2	15.2	20.4	23.6	26.8	32.2
full absorbed power (fans and compressors)	kW	4.6	7.2	7.4	9.0	9.6	12.0
compressor absorbed power	kW	3.6	5.2	6.0	7.4	7.4	9.2
each compressor absorbed current	A	6.8	7.3	8.3	6.0	6.0	7.6
fan absorbed power	kW	1.0	2.0	1.4	1.6	2.2	2.8
each fan absorbed current	A	2.1	4.1	3.3	3.7	5.1	6.2
SHR (Sensible Heat Ratio)	–	0.87	0.81	0.86	0.84	0.87	0.86
EER (Energy Efficiency Ratio)	–	2.83	2.59	3.19	3.12	3.17	3.12
SPL (Sound Pressure Level) (2)	dB(A)	52.4	54.7	57.7	62.7	53.9	58.9
FANS							
quantity	no.	2	2	2	2	2	2
type		dd 9/9	dd 9/9	dd 10/10	dd 10/10	dd 12/12	dd 12/12
speed	no.	3	3	3	3	3	3
motor rated power	kW	0.245	0.420	0.500	0.500	0.736	0.736
poles	no.	6	4	6	6	6	6
COMPRESSOR							
quantity	no.	2	2	2	2	2	2
type		scroll					
rated power for single compressor	HP	1.90	2.50	3.25	4.00	4.00	5.00
refrigerant		R407C	R407C	R407C	R407C	R407C	R407C
EVAPORATING COIL							
quantity	no.	2	2	2	2	2	2
pipes/fins		copper/aluminium			copper/treated aluminium		
fins for inch/rows	no.	12/3	12/3	12/4	12/4	12/5	12/5
front surface single coil	m ²	0.33	0.33	0.50	0.50	0.50	0.50
position		inclined					
REFRIGERANT CONNECTIONS							
gas line (pipe to be welded, o.d.)	mm	12	14	14	16	16	16
liquid line (pipe to be welded, o.d.)	mm	12	12	12	14	14	14
recommended diam. for refrigerant lines to the condenser (o.d.) Gas – Liquid	mm	10–10	12–12	12–12	14–14	14–14	16–16
DIMENSIONS							
length	mm	1490	1490	1490	1490	1490	1490
depth	mm	450	450	600	600	750	750
height	mm	1950	1950	1950	1950	1950	1950
plan surface	m ²	0.67	0.67	0.89	0.89	1.12	1.12
WEIGHTS							
net	kg	345	375	395	425	545	575
gross	kg	365	395	415	445	565	595

1 ON THE FOLLOWING STANDARD CONDITIONS: standard supply [voltage \pm 10%]; room conditions 24°C bs; 50% R.H. (17°C bu) – condensation temperature: 45°C

2 Measured in the front part at 1 m height, 2 m distance, referred to free field, with working fans and compressor.

ATTENTION: the refrigerating outputs are meant after deduction of the heat taken from the fans, which must thus be added to the room load. The EER refers only to the room unit. The unit air flow refers in standard configuration with clean class filter G3. The standard diameters of the pipings are valid only for lengths – between the conditioner and the condensing unit – up to 30 equivalent m.

Technical data and performances – air condensation – xxOA series, upward flow – 50Hz

MODEL		4MOA	4SOA	4LOA	6SOA	6LOA	8SOA	8LOA
power supply voltage	V/ph/Hz	230/1/50	400/3/50	400/3/50	400/3/50	400/3/50	400/3/50	400/3/50
PERFORMANCES (1)								
air flow	m ³ /s	0.33	0.40	0.59	0.68	0.73	1.08	1.13
available head	Pa	0	50	50	50	50	50	50
total cooling capacity	kW	4.8	5.2	7.8	9.9	11.5	13.0	15.8
sensible cooling capacity	kW	4.3	4.7	6.8	9.0	10.1	12.8	14.1
full absorbed power (fan and compressor)	kW	1.6	1.7	2.6	2.8	3.4	3.8	4.7
compressor absorbed power	kW	1.4	1.4	2.0	2.5	2.9	2.9	3.6
compressor absorbed current	A	6.0	6.5	3.8	4.5	5.9	5.9	7.4
fan absorbed power	kW	0.2	0.3	0.5	0.3	0.5	0.8	1.1
fan absorbed current	A	0.9	1.2	2.5	2.2	3.1	3.9	4.7
SHR (Sensible Heat Ratio)	–	0.88	0.89	0.87	0.91	0.88	0.98	0.89
EER (Energy Efficiency Ratio)	–	3.06	3.05	3.05	3.56	3.35	3.46	3.35
SPL (Sound Pressure Level) (2)	dB(A)	45.0	47.0	52.3	53.0	54.2	53.8	55.3
FANS								
quantity	no.	1	1	1	1	1	1	1
type		dd 9/9	dd 9/9	dd 9/9	dd 10/10	dd 10/10	dd 12/12	dd 12/12
speed	no.	3	3	3	3	3	3	3
motor rated power	kW	0.147	0.245	0.420	0.500	0.500	0.736	0.736
poles	no.	6	6	4	6	6	6	6
COMPRESSOR								
quantity	no.	1	1	1	1	1	1	1
type					scroll			
rated power for single compressor	HP	1.40	1.90	2.50	3.25	4.00	4.00	5.00
refrigerant		R22	R22	R22	R22	R22	R22	R22
EVAPORATING COIL								
quantity	no.	1	1	1	1	1	1	1
pipes/fins		copper/aluminium			copper/treated aluminium			
fins for inch/rows	no.	12/3	12/3	12/3	12/4	12/4	12/5	12/5
front surface	m ²	0.33	0.33	0.33	0.50	0.50	0.50	0.50
position		inclined						
REFRIGERANT CONNECTIONS								
gas line (pipe to be welded, o.d.)	mm	16	16	16	16	16	16	16
liquid line (pipe to be welded, o.d.)	mm	16	16	16	16	16	16	16
recommended diam. for refrigerant lines to the condenser (o.d.) Gas – Liquid	mm	10–10	10–10	12–12	12–12	14–14	16–16	16–16
DIMENSIONS								
length	mm	750	750	750	750	750	750	750
depth	mm	450	450	450	600	600	750	750
height	mm	1950	1950	1950	1950	1950	1950	1950
plan surface	m ²	0.34	0.34	0.34	0.45	0.45	0.56	0.56
WEIGHTS								
net	kg	180	180	195	205	220	280	295
gross	kg	190	190	205	215	230	290	305

1 ON THE FOLLOWING STANDARD CONDITIONS: standard supply [voltage \pm 10%]; room conditions 24°C bs; 50% R.H. (17°C bu) – condensation temperature: 45°C

2 Measured in the front part at 1 m height, 2 m distance, referred to free field, with working fans and compressor.

ATTENTION: the refrigerating outputs are meant after deduction of the heat taken from the fans, which must thus be added to the room load. The EER refers only to the room unit. The unit air flow refers in standard configuration with clean class filter G3. The standard diameters of the pipings are valid only for lengths – between the conditioner and the condensing unit – up to 30 equivalent m.

Technical data and performances – air condensation – xxOA series, upward flow – 50Hz

MODEL		5SOA	5LOA	7SOA	7LOA	9SOA	9LOA
power supply voltage	V/ph/Hz	400/3/50	400/3/50	400/3/50	400/3/50	400/3/50	400/3/50
PERFORMANCES (1)							
air flow	m ³ /s	0.80	1.18	1.36	1.46	2.16	2.26
available head	Pa	50	50	50	50	50	50
total cooling capacity	kW	10.4	15.6	19.8	23.0	26.0	31.6
sensible cooling capacity	kW	9.4	13.6	18.0	20.2	25.6	28.2
full absorbed power (fans and compressors)	kW	3.4	5.2	5.6	6.8	7.6	9.4
compressor absorbed power	kW	2.8	4.0	5.0	5.8	5.8	7.2
each compressor absorbed current	A	6.5	3.8	4.5	5.9	5.9	7.4
fan absorbed power	kW	0.6	1.0	0.6	1.0	1.6	2.2
each fan absorbed current	A	1.2	2.5	2.2	3.1	3.9	4.7
SHR (Sensible Heat Ratio)	–	0.89	0.87	0.91	0.88	0.98	0.89
EER (Energy Efficiency Ratio)	–	3.05	3.05	3.56	3.35	3.46	3.35
SPL (Sound Pressure Level) (2)	dB(A)	50.0	55.3	56.0	57.2	56.8	58.3
FANS							
quantity	no.	2	2	2	2	2	2
type		dd 9/9	dd 9/9	dd 10/10	dd 10/10	dd 12/12	dd 12/12
speed	no.	3	3	3	3	3	3
motor rated power	kW	0.245	0.420	0.500	0.500	0.736	0.736
poles	no.	6	4	6	6	6	6
COMPRESSOR							
quantity	no.	2	2	2	2	2	2
type		scroll					
rated power for single compressor	HP	1.90	2.50	3.25	4.00	4.00	5.00
refrigerant		R22	R22	R22	R22	R22	R22
EVAPORATING COIL							
quantity	no.	2	2	2	2	2	2
pipes/fins		copper/aluminium			copper/treated aluminium		
fins for inch/rows	no.	12/3	12/3	12/4	12/4	12/5	12/5
front surface single coil	m ²	0.33	0.33	0.50	0.50	0.50	0.50
position		inclined					
REFRIGERANT CONNECTIONS							
gas line (pipe to be welded, o.d.)	mm	16	16	16	16	16	16
liquid line (pipe to be welded, o.d.)	mm	16	16	16	16	16	16
recommended diam. for refrigerant lines to the condenser (o.d.) Gas – Liquid	mm	10–10	12–12	12–12	14–14	16–16	16–16
DIMENSIONS							
length	mm	1490	1490	1490	1490	1490	1490
depth	mm	450	450	600	600	750	750
height	mm	1950	1950	1950	1950	1950	1950
plan surface	m ²	0.67	0.67	0.89	0.89	1.12	1.12
WEIGHTS							
net	kg	345	375	395	425	545	575
gross	kg	365	395	415	445	565	595

1 ON THE FOLLOWING STANDARD CONDITIONS: standard supply [voltage \pm 10%]; room conditions 24°C bs; 50% R.H. (17°C bu) – condensation temperature: 45°C

2 Measured in the front part at 1 m height, 2 m distance, referred to free field, with working fans and compressor.

ATTENTION: the refrigerating outputs are meant after deduction of the heat taken from the fans, which must thus be added to the room load. The EER refers only to the room unit. The unit air flow refers in standard configuration with clean class filter G3. The standard diameters of the pipings are valid only for lengths – between the conditioner and the condensing unit – up to 30 equivalent m.

Technical data and performances – air condensation – xxOA series, upward flow – 60Hz

Dati tecnici e prestazioni, condensazione ad aria – serie xxOA, mandata verso l'alto – 60Hz

MODEL		4MOA	4SOA	4LOA	6SOA	6LOA	8SOA	8LOA
power supply voltage	V/ph/Hz	230/1/60	208–230 /1/60	200–230 /3/60	200–230 /3/60	380/3/60	380/3/60	380/3/60
PERFORMANCES (1)								
air flow	m ³ /s	0.31	0.50	0.61	0.77	0.85	1.05	1.28
available head	Pa	0	50	50	50	50	50	50
total cooling capacity	kW	5.4	6.3	9.1	11.9	13.7	15.2	18.8
sensible cooling capacity	kW	4.5	5.5	7.5	10.3	11.6	13.4	16.1
full absorbed power (fan and compressor)	kW	1.9	2.2	3.5	3.7	4.3	4.6	5.8
compressor absorbed power	kW	1.7	1.7	2.5	3.0	3.5	3.5	4.3
compressor absorbed current	A	5.9	6.5	6.6	7.8	5.9	5.9	7.4
fan absorbed power	kW	0.2	0.5	1.0	0.7	0.8	1.1	1.4
fan absorbed current	A	1.2	2.1	4.1	3.3	3.7	5.1	6.2
SHR (Sensible Heat Ratio)	–	0.84	0.87	0.82	0.87	0.85	0.88	0.86
EER (Energy Efficiency Ratio)	–	2.82	2.86	2.60	3.22	3.19	3.30	3.25
SPL (Sound Pressure Level) (2)	dB(A)	43.7	49.4	51.7	54.7	59.7	50.9	55.9
FANS								
quantity	no.	1	1	1	1	1	1	1
type		dd 9/9	dd 9/9	dd 9/9	dd 10/10	dd 10/10	dd 12/12	dd 12/12
speed	no.	3	3	3	3	3	3	3
motor rated power	kW	0.147	0.245	0.420	0.500	0.500	0.736	0.736
poles	no.	6	6	4	6	6	6	6
COMPRESSOR								
quantity	no.	1	1	1	1	1	1	1
type		scroll						
rated power for single compressor	HP	1.40	1.90	2.50	3.25	4.00	4.00	5.00
refrigerant		R22	R22	R22	R22	R22	R22	R22
EVAPORATING COIL								
quantity	no.	1	1	1	1	1	1	1
pipes/fins		copper/aluminium			copper/treated aluminium			
fins for inch/rows	no.	12/3	12/3	12/3	12/4	12/4	12/5	12/5
front surface	m ²	0.33	0.33	0.33	0.50	0.50	0.50	0.50
position		inclined						
REFRIGERANT CONNECTIONS								
gas line (pipe to be welded, o.d.)	mm	16	16	16	16	16	16	16
liquid line (pipe to be welded, o.d.)	mm	16	16	16	16	16	16	16
recommended diam. for refrigerant lines to the condenser (o.d.) Gas – Liquid	mm	10–10	10–10	12–12	12–12	14–14	16–16	16–16
DIMENSIONS								
length	mm	750	750	750	750	750	750	750
depth	mm	450	450	450	600	600	750	750
height	mm	1950	1950	1950	1950	1950	1950	1950
plan surface	m ²	0.34	0.34	0.34	0.45	0.45	0.56	0.56
WEIGHTS								
net	kg	180	180	195	205	220	280	295
gross	kg	190	190	205	215	230	290	305

1 ON THE FOLLOWING STANDARD CONDITIONS: standard supply [voltage \pm 10%]; room conditions 24°C bs; 50% R.H. (17°C bu) – condensation temperature: 45°C

2 Measured in the front part at 1 m height, 2 m distance, referred to free field, with working fans and compressor.

ATTENTION: the refrigerating outputs are meant after deduction of the heat taken from the fans, which must thus be added to the room load. The EER refers only to the room unit. The unit air flow refers in standard configuration with clean class filter G3. The standard diameters of the pipings are valid only for lengths – between the conditioner and the condensing unit – up to 30 equivalent m.

Technical data and performances – air condensation – xxOA series, upward flow – 60Hz

Dati tecnici e prestazioni, condensazione ad aria – serie xxOA, mandata verso l'alto – 60Hz

MODEL		5SOA	5LOA	7SOA	7LOA	9SOA	9LOA
power supply voltage	V/ph/Hz	208–230 /1/60	200–230 /3/60	200–230 /3/60	380/3/60	380/3/60	380/3/60
PERFORMANCES (1)							
air flow	m ³ /s	1.00	1.22	1.54	1.70	2.10	2.56
available head	Pa	50	50	50	50	50	50
total cooling capacity	kW	12.6	18.2	23.8	27.4	30.4	37.6
sensible cooling capacity	kW	10.1	15.0	20.6	23.2	26.8	32.2
full absorbed power (fans and compressors)	kW	4.4	7.0	7.4	8.6	9.2	11.6
compressor absorbed power	kW	3.4	5.0	6.0	7.0	7.0	8.6
each compressor absorbed current	A	6.5	6.6	7.8	5.9	5.9	7.4
fan absorbed power	kW	1.0	2.0	1.4	1.6	2.2	2.8
each fan absorbed current	A	2.1	4.1	3.3	3.7	5.1	6.2
SHR (Sensible Heat Ratio)	–	0.87	0.82	0.87	0.85	0.88	0.86
EER (Energy Efficiency Ratio)	–	2.86	2.60	3.22	3.19	3.30	3.25
SPL (Sound Pressure Level) (2)	dB(A)	52.4	54.7	57.7	62.7	53.9	58.9
FANS							
quantity	no.	2	2	2	2	2	2
type		dd 9/9	dd 9/9	dd 10/10	dd 10/10	dd 12/12	dd 12/12
speed	no.	3	3	3	3	3	3
motor rated power	kW	0.245	0.420	0.500	0.500	0.736	0.736
poles	no.	6	4	6	6	6	6
COMPRESSOR							
quantity	no.	2	2	2	2	2	2
type		scroll					
rated power for single compressor	HP	1.90	2.50	3.25	4.00	4.00	5.00
refrigerant		R22	R22	R22	R22	R22	R22
EVAPORATING COIL							
quantity	no.	2	2	2	2	2	2
pipes/fins		copper/aluminium			copper/treated aluminium		
fins for inch/rows	no.	12/3	12/3	12/4	12/4	12/5	12/5
front surface single coil	m ²	0.33	0.33	0.50	0.50	0.50	0.50
position		inclined					
REFRIGERANT CONNECTIONS							
gas line (pipe to be welded, o.d.)	mm	16	16	16	16	16	16
liquid line (pipe to be welded, o.d.)	mm	16	16	16	16	16	16
recommended diam. for refrigerant lines to the condenser (o.d.) Gas – Liquid	mm	10–10	12–12	12–12	14–14	16–16	16–16
DIMENSIONS							
length	mm	1490	1490	1490	1490	1490	1490
depth	mm	450	450	600	600	750	750
height	mm	1950	1950	1950	1950	1950	1950
plan surface	m ²	0.67	0.67	0.89	0.89	1.12	1.12
WEIGHTS							
net	kg	345	375	395	425	545	575
gross	kg	365	395	415	445	565	595

1 ON THE FOLLOWING STANDARD CONDITIONS: standard supply [voltage \pm 10%]; room conditions 24°C bs; 50% R.H. (17°C bu) – condensation temperature: 45°C

2 Measured in the front part at 1 m height, 2 m distance, referred to free field, with working fans and compressor.

ATTENTION: the refrigerating outputs are meant after deduction of the heat taken from the fans, which must thus be added to the room load. The EER refers only to the room unit. The unit air flow refers in standard configuration with clean class filter G3. The standard diameters of the pipings are valid only for lengths – between the conditioner and the condensing unit – up to 30 equivalent m.

Technical data and performances – air condensation – xxCA series, upward flow – 50Hz

MODEL		4PCA	4GCA	6PCA	8PCA
power supply voltage	V/ph/Hz	400/3/50	400/3/50	400/3/50	400/3/50
PERFORMANCES (1)					
air flow	m ³ /s	0.36	0.53	0.61	0.97
available head	Pa	50	50	50	50
total cooling capacity	kW	5.2	7.9	9.9	13.0
sensible cooling capacity	kW	4.5	6.6	8.5	12.0
full absorbed power (fan and compressor)	kW	1.8	2.8	2.9	3.9
compressor absorbed power	kW	1.5	2.2	2.5	3.1
compressor absorbed current	A	6.8	4.2	4.8	6.0
fan absorbed power	kW	0.3	0.6	0.4	0.8
fan absorbed current	A	1.4	2.4	2.2	4.2
SHR (Sensible Heat Ratio)	–	0.86	0.84	0.86	0.93
EER (Energy Efficiency Ratio)	–	2.97	2.85	3.38	3.32
SPL (Sound Pressure Level) (2)	dB(A)	47.0	52.3	53.0	53.8
FANS					
quantity	no.	1	1	1	1
type		dd 9/9	dd 9/9	dd 10/10	dd 12/12
speed	no.	3	3	3	3
motor rated power	kW	0.245	0.420	0.500	0.736
poles	no.	6	4	6	6
COMPRESSOR					
quantity	no.	1	1	1	1
type				scroll	
rated power for single compressor	HP	1.90	2.50	3.25	4.00
refrigerant		R407C	R407C	R407C	R407C
EVAPORATING COIL					
quantity	no.	1	1	1	1
pipes/fins			copper/aluminium		copper/treated aluminium
fins for inch/rows	no.	12/3	12/3	12/3	12/4
front surface	m ²	0.33	0.33	0.33	0.50
position				inclined	
REFRIGERANT CONNECTIONS					
gas line (pipe to be welded, o.d.)	mm	12	14	14	16
liquid line (pipe to be welded, o.d.)	mm	12	12	12	14
recommended diam. for refrigerant lines to the condenser (o.d.) Gas – Liquid	mm	10–10	12–12	12–12	14–14
DIMENSIONS					
length	mm	750	750	750	750
depth	mm	450	450	600	750
height	mm	1950	1950	1950	1950
plan surface	m ²	0.34	0.34	0.45	0.56
WEIGHTS					
net	kg	180	180	195	205
gross	kg	190	190	205	215

1 ON THE FOLLOWING STANDARD CONDITIONS: standard supply [voltage \pm 10%]; room conditions 24°C bs; 50% R.H. (17°C bu) – condensation temperature: 45°C

2 Measured in the front part at 1 m height, 2 m distance, referred to free field, with working fans and compressor.

ATTENTION: the refrigerating outputs are meant after deduction of the heat taken from the fans, which must thus be added to the room load. The EER refers only to the room unit. The unit air flow refers in standard configuration with clean class filter G3. The standard diameters of the pipings are valid only for lengths – between the conditioner and the condensing unit – up to 30 equivalent m.

Technical data and performances – air condensation – xxCA series, upward flow – 60Hz

MODEL		4PCA	4GCA	6PCA	8PCA
power supply voltage	V/ph/Hz	208–230/1/60	200–230/3/60	200–230/3/60	380/3/60
PERFORMANCES (1)					
air flow	m ³ /s	0.38	0.53	0.64	0.99
available head	Pa	0	50	50	50
total cooling capacity	kW	6.1	9.1	11.5	15.2
sensible cooling capacity	kW	5.0	7.1	9.4	13.0
full absorbed power (fan and compressor)	kW	2.2	3.6	3.5	4.8
compressor absorbed power	kW	1.8	2.6	3.0	3.7
compressor absorbed current	A	6.8	7.3	8.3	6.0
fan absorbed power	kW	0.4	1.0	0.5	1.1
fan absorbed current	A	1.9	3.9	2.5	4.6
SHR (Sensible Heat Ratio)	–	0.81	0.79	0.82	0.86
EER (Energy Efficiency Ratio)	–	2.83	2.55	3.25	3.18
SPL (Sound Pressure Level) (2)	dB(A)	49.4	51.7	54.7	50.9
FANS					
quantity	no.	1	1	1	1
type		dd 9/9	dd 9/9	dd 10/10	dd 12/12
speed	no.	3	3	3	3
motor rated power	kW	0.245	0.420	0.500	0.736
poles	no.	6	4	6	6
COMPRESSOR					
quantity	no.	1	1	1	1
type				scroll	
rated power for single compressor	HP	1.90	2.50	3.25	4.00
refrigerant		R407C	R407C	R407C	R407C
EVAPORATING COIL					
quantity	no.	1	1	1	1
pipes/fins			copper/aluminium		copper/treated aluminium
fins for inch/rows	no.	12/3	12/3	12/4	12/5
front surface	m ²	0.33	0.33	0.33	0.50
position				inclined	
REFRIGERANT CONNECTIONS					
gas line (pipe to be welded, o.d.)	mm	12	14	14	16
liquid line (pipe to be welded, o.d.)	mm	12	12	12	14
recommended diam. for refrigerant lines to the condenser (o.d.) Gas – Liquid	mm	10–10	12–12	12–12	14–14
DIMENSIONS					
length	mm	750	750	750	750
depth	mm	450	450	600	750
height	mm	1950	1950	1950	1950
plan surface	m ²	0.34	0.34	0.45	0.56
WEIGHTS					
net	kg				
gross	kg				

1 ON THE FOLLOWING STANDARD CONDITIONS: standard supply [voltage \pm 10%]; room conditions 24°C bs; 50% R.H. (17°C bu) – condensation temperature: 45°C

2 Measured in the front part at 1 m height, 2 m distance, referred to free field, with working fans and compressor.

ATTENTION: the refrigerating outputs are meant after deduction of the heat taken from the fans, which must thus be added to the room load. The EER refers only to the room unit. The unit air flow refers in standard configuration with clean class filter G3. The standard diameters of the pipings are valid only for lengths – between the conditioner and the condensing unit – up to 30 equivalent m.

Technical data and performances – air condensation – xxCA series, upward flow – 50Hz

MODEL		4SCA	4LCA	6SCA	8SCA
power supply voltage	V/ph/Hz	400/3/50	400/3/50	400/3/50	400/3/50
PERFORMANCES (1)					
air flow	m ³ /s	0.36	0.53	0.61	0.97
available head	Pa	50	50	50	50
total cooling capacity	kW	5.1	7.8	9.9	12.8
sensible cooling capacity	kW	4.5	6.5	8.6	12.1
full absorbed power (fan and compressor)	kW	1.7	2.7	2.9	3.7
compressor absorbed power	kW	1.4	2.1	2.5	2.9
compressor absorbed current	A	6.5	3.8	4.5	5.9
fan absorbed power	kW	0.3	0.6	0.4	0.8
fan absorbed current	A	1.4	2.4	2.2	4.2
SHR (Sensible Heat Ratio)	–	0.87	0.84	0.87	0.94
EER (Energy Efficiency Ratio)	–	3.09	2.93	3.44	3.44
SPL (Sound Pressure Level) (2)	dB(A)	47.0	52.3	53.0	53.8
FANS					
quantity	no.	1	1	1	1
type		dd 9/9	dd 9/9	dd 10/10	dd 12/12
speed	no.	3	3	3	3
motor rated power	kW	0.245	0.420	0.500	0.736
poles	no.	6	4	6	6
COMPRESSOR					
quantity	no.	1	1	1	1
type				scroll	
rated power for single compressor	HP	1.90	2.50	3.25	4.00
refrigerant		R22	R22	R22	R22
EVAPORATING COIL					
quantity	no.	1	1	1	1
pipes/fins			copper/aluminium		copper/treated aluminium
fins for inch/rows	no.	12/3	12/3	12/3	12/4
front surface	m ²	0.33	0.33	0.33	0.50
position				inclined	
REFRIGERANT CONNECTIONS					
gas line (pipe to be welded, o.d.)	mm	16	16	16	16
liquid line (pipe to be welded, o.d.)	mm	16	16	16	16
recommended diam. for refrigerant lines to the condenser (o.d.) Gas – Liquid	mm	10–10	12–12	12–12	14–14
DIMENSIONS					
length	mm	750	750	750	750
depth	mm	450	450	600	750
height	mm	1950	1950	1950	1950
plan surface	m ²	0.34	0.34	0.45	0.56
WEIGHTS					
net	kg	180	180	195	205
gross	kg	190	190	205	215

1 ON THE FOLLOWING STANDARD CONDITIONS: standard supply [voltage \pm 10%]; room conditions 24°C bs; 50% R.H. (17°C bu) – condensation temperature: 45°C

2 Measured in the front part at 1 m height, 2 m distance, referred to free field, with working fans and compressor.

ATTENTION: the refrigerating outputs are meant after deduction of the heat taken from the fans, which must thus be added to the room load. The EER refers only to the room unit. The unit air flow refers in standard configuration with clean class filter G3. The standard diameters of the pipings are valid only for lengths – between the conditioner and the condensing unit – up to 30 equivalent m.

Technical data and performances – air condensation – xxCA series, upward flow – 60Hz

MODEL		4SCA	4LCA	6SCA	8SCA
power supply voltage	V/ph/Hz	208–230/1/60	200–230/3/60	200–230/3/60	380/3/60
PERFORMANCES (1)					
air flow	m ³ /s	0.38	0.53	0.64	0.99
available head	Pa	50	50	50	50
total cooling capacity	kW	6.1	8.9	11.5	15.1
sensible cooling capacity	kW	4.9	7.1	9.5	13.1
full absorbed power (fan and compressor)	kW	2.1	3.4	3.5	4.6
compressor absorbed power	kW	1.7	2.5	3.0	3.5
compressor absorbed current	A	6.5	6.6	7.8	5.9
fan absorbed power	kW	0.4	1.0	0.5	1.1
fan absorbed current	A	1.9	3.9	2.5	4.6
SHR (Sensible Heat Ratio)	–	0.82	0.80	0.82	0.86
EER (Energy Efficiency Ratio)	–	2.90	2.61	3.31	3.31
SPL (Sound Pressure Level) (2)	dB(A)	49.4	51.7	54.7	50.9
FANS					
quantity	no.	1	1	1	1
type		dd 9/9	dd 9/9	dd 10/10	dd 12/12
speed	no.	3	3	3	3
motor rated power	kW	0.245	0.420	0.500	0.736
poles	no.	6	4	6	6
COMPRESSOR					
quantity	no.	1	1	1	1
type				scroll	
rated power for single compressor	HP	1.90	2.50	3.25	4.00
refrigerant		R22	R22	R22	R22
EVAPORATING COIL					
quantity	no.	1	1	1	1
pipes/fins			copper/aluminium		copper/treated aluminium
fins for inch/rows	no.	12/3	12/3	12/4	12/5
front surface	m ²	0.33	0.33	0.33	0.50
position				inclined	
REFRIGERANT CONNECTIONS					
gas line (pipe to be welded, o.d.)	mm	16	16	16	16
liquid line (pipe to be welded, o.d.)	mm	16	16	16	16
recommended diam. for refrigerant lines to the condenser (o.d.) Gas – Liquid	mm	10–10	12–12	12–12	14–14
DIMENSIONS					
length	mm	750	750	750	750
depth	mm	450	450	600	750
height	mm	1950	1950	1950	1950
plan surface	m ²	0.34	0.34	0.45	0.56
WEIGHTS					
net	kg				
gross	kg				

1 ON THE FOLLOWING STANDARD CONDITIONS: standard supply [voltage \pm 10%]; room conditions 24°C bs; 50% R.H. (17°C bu) – condensation temperature: 45°C

2 Measured in the front part at 1 m height, 2 m distance, referred to free field, with working fans and compressor.

ATTENTION: the refrigerating outputs are meant after deduction of the heat taken from the fans, which must thus be added to the room load. The EER refers only to the room unit. The unit air flow refers in standard configuration with clean class filter G3. The standard diameters of the pipings are valid only for lengths – between the conditioner and the condensing unit – up to 30 equivalent m.

Technical data and performances—water condensation —xxUW series, downward flow—50Hz

MODEL		4PUW	4GUW	6PUW	6GUW	8PUW	8GUW
power supply voltage	V/ph/Hz	400/3/50	400/3/50	400/3/50	400/3/50	400/3/50	400/3/50
PERFORMANCES (1)							
air flow	m ³ /s	0.46	0.64	0.74	0.80	1.21	1.31
available head	Pa	20	20	20	20	20	20
fan absorbed power	kW	0.3	0.6	0.4	0.5	0.9	1.2
fan absorbed current	A	1.4	2.6	2.6	3.3	4.5	5.4
sound pressure level (2)	dB(A)	46.9	50.1	50.0	51.3	50.3	52.6
condenser inlet water temperature: 15°C; condensation temperature: 40°C							
total cooling capacity	kW	5.8	8.7	10.7	12.8	14.1	17.1
sensible cooling capacity	kW	5.1	7.4	9.3	11.1	13.9	15.5
full absorbed power (fan and compressor)	kW	1.6	2.5	2.6	3.2	3.7	4.7
compressor absorbed power	kW	1.3	1.9	2.2	2.8	2.8	3.4
compressor absorbed current	A	6.1	3.9	4.4	5.6	5.7	7.2
SHR (Sensible Heat Ratio)	—	0.88	0.85	0.87	0.86	0.99	0.91
EER (Energy Efficiency Ratio)	—	3.60	3.53	4.12	4.00	3.84	3.67
water flow	l/s	0.05	0.09	0.09	0.12	0.13	0.17
water pressure drop	kPa	1	2	1	2	2	3
condenser inlet water temperature: 30°C; condensation temperature: 45°C							
total cooling capacity	kW	5.6	8.3	10.2	12.2	13.4	16.3
sensible cooling capacity	kW	5.0	7.2	9.1	10.8	13.4	15.2
full absorbed power (fan and compressor)	kW	1.8	2.7	2.9	3.6	4.0	5.0
compressor absorbed power	kW	1.5	2.2	2.5	3.1	3.1	3.8
compressor absorbed current	A	6.8	4.2	4.8	6.0	6.0	7.6
SHR (Sensible Heat Ratio)	—	0.90	0.87	0.89	0.88	1.00	0.93
EER (Energy Efficiency Ratio)	—	3.12	3.07	3.55	3.45	3.33	3.23
water flow	l/s	0.11	0.20	0.20	0.27	0.30	0.40
water pressure drop	kPa	3	10	4	6	8	14
FANS							
quantity	no.	1	1	1	1	1	1
type	—	dd 9/9	dd 9/9	dd 10/10	dd 10/10	dd 12/12	dd 12/12
speed	no.	3	3	3	3	3	3
nominal power	kW	0.245	0.420	0.500	0.500	0.736	0.736
poles	no.	6	4	6	6	6	6
COMPRESSOR							
quantity/type					1/scroll		
nominal power for each compressor	HP	1.90	2.50	3.25	4.00	4.00	5.00
refrigerant		R407C	R407C	R407C	R407C	R407C	R407C
EVAPORATING COIL							
pipes/fins		copper/aluminium			copper/treated aluminium		
fins for inch/rows	no.	12/3	12/3	12/4	12/4	12/5	12/5
front surface	m ²	0.33	0.33	0.50	0.50	0.50	0.50
position/quantity		inclined/1					
CONDENSER							
quantity/type	—	1/plate					
water connections	inch	½" BSP					
DIMENSIONS							
length	mm	750	750	750	750	750	750
depth	mm	450	450	600	600	750	750
height	mm	1950	1950	1950	1950	1950	1950
plan surface	m ²	0.34	0.34	0.45	0.45	0.56	0.56
WEIGHTS							
net	kg	185	200	210	225	285	300
gross	kg	195	210	220	235	295	310

1 ON THE FOLLOWING STANDARD CONDITIONS: standard supply [voltage ± 10%]; room conditions 24°C bs; 50% R.H. (17°C bu)

2 Measured in the front part at 1 m height, 2 m distance, referred to free field, with working fans and compressor.

ATTENTION: the refrigerating outputs are meant after deduction of the heat taken from the fans, which must thus be added to the room load. The EER refers only to the room unit. The unit air flow refers in standard configuration with clean class filter G3.

Technical data and performances—water condensation –xxUW series, downward flow—50Hz

MODEL		5PUW	5GUW	7PUW	7GUW	9PUW	9GUW
power supply voltage	V/ph/Hz	400/3/50	400/3/50	400/3/50	400/3/50	400/3/50	400/3/50
PERFORMANCES (1)							
air flow	m ³ /s	0.92	1.28	1.48	1.60	2.42	2.62
available head	Pa	20	20	20	20	20	20
fans absorbed power	kW	0.6	1.2	0.8	1.0	1.8	2.4
each fans absorbed current	A	1.4	2.6	2.6	3.3	4.5	5.4
sound pressure level (2)	dB(A)	49.9	53.1	53.0	54.3	53.3	55.6
condenser inlet water temperature: 15°C; condensation temperature: 40°C							
total cooling capacity	kW	11.6	17.4	21.4	25.6	28.2	34.2
sensible cooling capacity	kW	10.2	14.8	18.6	22.2	27.8	31.0
full absorbed power (fans and compressors)	kW	3.2	5.0	5.2	6.4	7.4	9.4
compressors absorbed power	kW	2.6	3.8	4.4	5.6	5.6	6.8
each compressors absorbed current	A	6.1	3.9	4.4	5.6	5.7	7.2
SHR (Sensible Heat Ratio)	–	0.88	0.85	0.87	0.86	0.99	0.91
EER (Energy Efficiency Ratio)	–	3.60	3.53	4.12	4.00	3.84	3.67
water flow	l/s	0.10	0.18	0.18	0.24	0.26	0.34
water pressure drop	kPa	1	2	1	2	2	3
condenser inlet water temperature: 30°C; condensation temperature: 45°C							
total cooling capacity	kW	11.2	16.6	20.4	24.4	26.8	32.6
sensible cooling capacity	kW	10.0	14.4	18.2	21.6	26.8	30.4
full absorbed power (fans and compressors)	kW	3.6	5.4	5.8	7.2	8.0	10.0
compressors absorbed power	kW	3.0	4.4	5.0	6.2	6.2	7.6
each compressors absorbed current	A	6.8	4.2	4.8	6.0	6.0	7.6
SHR (Sensible Heat Ratio)	–	0.90	0.87	0.89	0.88	1.00	0.93
EER (Energy Efficiency Ratio)	–	3.12	3.07	3.55	3.45	3.33	3.23
water flow	l/s	0.22	0.40	0.40	0.54	0.60	0.80
water pressure drop	kPa	3	10	4	6	8	14
FANS							
quantity	no.	2	2	2	2	2	2
type	–	dd 9/9	dd 9/9	dd 10/10	dd 10/10	dd 12/12	dd 12/12
speed	no.	3	3	3	3	3	3
nominal power	kW	0.245	0.420	0.500	0.500	0.736	0.736
poles	no.	6	4	6	6	6	6
COMPRESSORS							
quantity/type		2/scroll					
nominal power for each compressor	HP	1.90	2.50	3.25	4.00	4.00	5.00
refrigerant		R407C	R407C	R407C	R407C	R407C	R407C
EVAPORATING COIL							
pipes/fins		copper/aluminium			copper/treated aluminium		
fins for inch/rows	no.	12/3	12/3	12/4	12/4	12/5	12/5
front surface single coil	m ²	0.33	0.33	0.50	0.50	0.50	0.50
position/quantity		inclined/2					
CONDENSER							
quantity/type	–	2/plate					
water connections	inch	½" BSP					
DIMENSIONS							
length	mm	1490	1490	1490	1490	1490	1490
depth	mm	450	450	600	600	750	750
height	mm	1950	1950	1950	1950	1950	1950
plan surface	m ²	0.67	0.67	0.89	0.89	1.12	1.12
WEIGHTS							
net	kg	355	385	405	435	555	585
gross	kg	375	405	425	455	575	605

1 ON THE FOLLOWING STANDARD CONDITIONS: standard supply [voltage ± 10%]; room conditions 24°C bs; 50% R.H. (17°C bu)

2 Measured in the front part at 1 m height, 2 m distance, referred to free field, with working fans and compressor.

ATTENTION: the refrigerating outputs are meant after deduction of the heat taken from the fans, which must thus be added to the room load. The EER refers only to the room unit. The unit air flow refers in standard configuration with clean class filter G3.

Technical data and performances—water condensation —xxUW series, downward flow—60Hz

MODEL		4PUW	4GUW	6PUW	6GUW	8PUW	8GUW
power supply voltage	V/ph/Hz	208–230/1 /60	200–230/3 /60	200–230/3 /60	380/3/60	380/3/60	380/3/60
PERFORMANCES (1)							
air flow	m ³ /s	0.46	0.64	0.74	0.80	1.21	1.31
available head	Pa	20	20	20	20	20	20
fan absorbed power	kW	0.3	0.6	0.4	0.5	0.9	1.1
fan absorbed current	A	2.3	4.3	3.7	4.0	5.9	7.1
sound pressure level (2)	dB(A)	49.8	49.4	51.5	54.9	47.6	53.1
condenser inlet water temperature: 15°C; condensation temperature: 40°C							
total cooling capacity	kW	7.0	10.0	12.6	15.1	16.3	20.0
sensible cooling capacity	kW	5.9	8.0	10.4	12.6	14.3	17.0
full absorbed power (fan and compressor)	kW	1.9	2.8	3.0	3.8	4.2	5.2
compressor absorbed power	kW	1.5	2.3	2.7	3.3	3.3	4.1
compressor absorbed current	A	6.1	6.8	7.6	5.6	5.6	7.2
SHR (Sensible Heat Ratio)	–	0.85	0.80	0.82	0.83	0.88	0.85
EER (Energy Efficiency Ratio)	–	3.72	3.50	4.13	4.02	3.87	3.86
water flow	l/s	0.06	0.10	0.12	0.15	0.16	0.21
water pressure drop	kPa	1	3	2	2	3	4
condenser inlet water temperature: 30°C; condensation temperature: 45°C							
total cooling capacity	kW	6.7	9.6	12.0	14.5	15.6	19.1
sensible cooling capacity	kW	5.8	7.8	10.1	12.3	14.0	16.6
full absorbed power (fan and compressor)	kW	2.1	3.1	3.4	4.2	4.6	5.7
compressor absorbed power	kW	1.7	2.6	3.0	3.7	3.7	4.6
compressor absorbed current	A	6.8	7.3	8.3	6.0	6.0	7.6
SHR (Sensible Heat Ratio)	–	0.87	0.81	0.84	0.85	0.90	0.87
EER (Energy Efficiency Ratio)	–	3.22	3.07	3.55	3.47	3.37	3.39
water flow	l/s	0.14	0.25	0.26	0.34	0.37	0.51
water pressure drop	kPa	5	15	6	10	12	23
FANS							
quantity	no.	1	1	1	1	1	1
type	–	dd 9/9	dd 9/9	dd 10/10	dd 10/10	dd 12/12	dd 12/12
speed	no.	3	3	3	3	3	3
nominal power	kW	0.245	0.420	0.500	0.500	0.736	0.736
poles	no.	6	4	6	6	6	6
COMPRESSOR							
quantity/type					1/scroll		
nominal power for each compressor	HP	1.90	2.50	3.25	4.00	4.00	5.00
refrigerant		R407C	R407C	R407C	R407C	R407C	R407C
EVAPORATING COIL							
pipes/fins		copper/aluminium			copper/treated aluminium		
fins for inch/rows	no.	12/3	12/3	12/4	12/4	12/5	12/5
front surface	m ²	0.33	0.33	0.50	0.50	0.50	0.50
position/quantity		inclined/1					
CONDENSER							
quantity/type	–	1/plate					
water connections	inch	½" BSP					
DIMENSIONS							
length	mm	750	750	750	750	750	750
depth	mm	450	450	600	600	750	750
height	mm	1950	1950	1950	1950	1950	1950
plan surface	m ²	0.34	0.34	0.45	0.45	0.56	0.56
WEIGHTS							
net	kg	185	200	210	225	285	300
gross	kg	195	210	220	235	295	310

1 ON THE FOLLOWING STANDARD CONDITIONS: standard supply [voltage ± 10%]; room conditions 24°C bs; 50% R.H. (17°C bu)

2 Measured in the front part at 1 m height, 2 m distance, referred to free field, with working fans and compressor.

ATTENTION: the refrigerating outputs are meant after deduction of the heat taken from the fans, which must thus be added to the room load. The EER refers only to the room unit. The unit air flow refers in standard configuration with clean class filter G3.

Technical data and performances—water condensation –xxUW series, downward flow—60Hz

MODEL		5PUW	5GUW	7PUW	7GUW	9PUW	9GUW
power supply voltage	V/ph/Hz	208–230/1/60	200–230/3/60	200–230/3/60	380/3/60	380/3/60	380/3/60
PERFORMANCES (1)							
air flow	m ³ /s	0.92	1.28	1.48	1.60	2.42	2.62
available head	Pa	20	20	20	20	20	20
fan absorbed power	kW	0.6	1.2	0.8	1.0	1.8	2.2
each fans absorbed current	A	2.3	4.3	3.7	4.0	5.9	7.1
sound pressure level (2)	dB(A)	52.8	52.4	54.5	57.9	50.6	56.1
condenser inlet water temperature: 15°C; condensation temperature: 40°C							
total cooling capacity	kW	14.0	20.0	25.2	30.2	32.6	40.0
sensible cooling capacity	kW	11.8	16.0	20.8	25.2	28.6	34.0
full absorbed power (fans and compressors)	kW	3.8	5.6	6.0	7.6	8.4	10.4
compressors absorbed power	kW	3.0	4.6	5.4	6.6	6.6	8.2
each compressors absorbed current	A	6.1	6.8	7.6	5.6	5.6	7.2
SHR (Sensible Heat Ratio)	–	0.85	0.80	0.82	0.83	0.88	0.85
EER (Energy Efficiency Ratio)	–	3.72	3.50	4.13	4.02	3.87	3.86
water flow	l/s	0.12	0.20	0.24	0.30	0.32	0.42
water pressure drop	kPa	1	3	2	2	3	4
condenser inlet water temperature: 30°C; condensation temperature: 45°C							
total cooling capacity	kW	13.4	19.2	24.0	29.0	31.2	38.2
sensible cooling capacity	kW	11.6	15.6	20.2	24.6	28.0	33.2
full absorbed power (fans and compressors)	kW	4.2	6.2	6.8	8.4	9.2	11.4
compressors absorbed power	kW	3.4	5.2	6.0	7.4	7.4	9.2
each compressors absorbed current	A	6.8	7.3	8.3	6.0	6.0	7.6
SHR (Sensible Heat Ratio)	–	0.87	0.81	0.84	0.85	0.90	0.87
EER (Energy Efficiency Ratio)	–	3.22	3.07	3.55	3.47	3.37	3.39
water flow	l/s	0.28	0.50	0.52	0.68	0.74	1.02
water pressure drop	kPa	5	15	6	10	12	23
FANS							
quantity	no.	2	2	2	2	2	2
type	–	dd 9/9	dd 9/9	dd 10/10	dd 10/10	dd 12/12	dd 12/12
speed	no.	3	3	3	3	3	3
nominal power	kW	0.245	0.420	0.500	0.500	0.736	0.736
poles	no.	6	4	6	6	6	6
COMPRESSORS							
quantity/type				2/scroll			
nominal power for each compressor	HP	1.90	2.50	3.25	4.00	4.00	5.00
refrigerant		R407C	R407C	R407C	R407C	R407C	R407C
EVAPORATING COIL							
pipes/fins		copper/aluminium			copper/treated aluminium		
fins for inch/rows	no.	12/3	12/3	12/4	12/4	12/5	12/5
front surface single coil	m ²	0.33	0.33	0.50	0.50	0.50	0.50
position/quantity		inclined/2					
CONDENSER							
quantity/type	–	2/plate					
water connections	inch	½" BSP					
DIMENSIONS							
length	mm	1490	1490	1490	1490	1490	1490
depth	mm	450	450	600	600	750	750
height	mm	1950	1950	1950	1950	1950	1950
plan surface	m ²	0.67	0.67	0.89	0.89	1.12	1.12
WEIGHTS							
net	kg	355	385	405	435	555	585
gross	kg	375	405	425	455	575	605

1 ON THE FOLLOWING STANDARD CONDITIONS: standard supply [voltage ± 10%]; room conditions 24°C bs; 50% R.H. (17°C bu)

2 Measured in the front part at 1 m height, 2 m distance, referred to free field, with working fans and compressor.

ATTENTION: the refrigerating outputs are meant after deduction of the heat taken from the fans, which must thus be added to the room load. The EER refers only to the room unit. The unit air flow refers in standard configuration with clean class filter G3.

Technical data and performances—water condensation—xxUW series, downward flow — 50Hz

MODEL		4SUW	4LUW	6SUW	6LUW	8SUW	8LUW
power supply voltage	V/ph/Hz	400/3/50	400/3/50	400/3/50	400/3/50	400/3/50	400/3/50
PERFORMANCES (1)							
air flow	m ³ /s	0.46	0.64	0.74	0.80	1.21	1.31
available head	Pa	20	20	20	20	20	20
fan absorbed power	kW	0.3	0.6	0.4	0.5	0.9	1.2
fan absorbed current	A	1.4	2.6	2.6	3.3	4.5	5.4
sound pressure level (2)	dB(A)	46.9	50.1	50.0	51.3	50.3	52.6
condenser inlet water temperature: 15 °C; condensation temperature: 40 °C							
total cooling capacity	kW	5.7	8.4	10.5	12.1	13.5	16.8
sensible cooling capacity	kW	5.1	7.3	9.2	10.7	13.5	15.5
full absorbed power (fan and compressor)	kW	1.6	2.4	2.6	3.1	3.5	4.5
compressor absorbed power	kW	1.2	1.8	2.2	2.6	2.6	3.2
compressor absorbed current	A	5.9	3.5	4.2	5.6	5.6	7.0
SHR (Sensible Heat Ratio)	—	0.89	0.87	0.88	0.89	1.00	0.92
EER (Energy Efficiency Ratio)	—	3.60	3.54	4.03	3.93	3.83	3.76
water flow	l/s	0.05	0.08	0.09	0.11	0.13	0.17
water pressure drop	kPa	1	2	1	2	2	3
condenser inlet water temperature: 30 °C; condensation temperature: 45 °C							
total cooling capacity	kW	5.5	8.1	10.2	11.7	13.3	16.2
sensible cooling capacity	kW	5.0	7.1	9.1	10.6	13.3	15.3
full absorbed power (fan and compressor)	kW	1.7	2.6	2.8	3.4	3.8	4.9
compressor absorbed power	kW	1.4	2.0	2.5	2.9	2.9	3.6
compressor absorbed current	A	6.5	3.8	4.5	5.9	5.9	7.4
SHR (Sensible Heat Ratio)	—	0.91	0.88	0.89	0.91	1.00	0.94
EER (Energy Efficiency Ratio)	—	3.22	3.13	3.59	3.46	3.47	3.34
water flow	l/s	0.11	0.19	0.20	0.25	0.29	0.39
water pressure drop	kPa	3	9	4	6	7	13
FANS							
quantity	no.	1	1	1	1	1	1
type	—	dd 9/9	dd 9/9	dd 10/10	dd 10/10	dd 12/12	dd 12/12
speed	no.	3	3	3	3	3	3
nominal power	kW	0.245	0.420	0.500	0.500	0.736	0.736
poles	no.	6	4	6	6	6	6
COMPRESSOR							
quantity/type					1/scroll		
nominal power for each compressor	HP	1.90	2.50	3.25	4.00	4.00	5.00
refrigerant		R22	R22	R22	R22	R22	R22
EVAPORATING COIL							
pipes/fins		copper/aluminium			copper/treated aluminium		
fins for inch/rows	no.	12/3	12/3	12/4	12/4	12/5	12/5
front surface	m ²	0.33	0.33	0.50	0.50	0.50	0.50
position/quantity				inclined/1			
CONDENSER							
quantity/type	—				1/plate		
water connections	inch				½" BSP		
DIMENSIONS							
length	mm	750	750	750	750	750	750
depth	mm	450	450	600	600	750	750
height	mm	1950	1950	1950	1950	1950	1950
plan surface	m ²	0.34	0.34	0.45	0.45	0.56	0.56
WEIGHTS							
net	kg	185	200	210	225	285	300
gross	kg	195	210	220	235	295	310

1 ON THE FOLLOWING STANDARD CONDITIONS: standard supply [voltage ± 10%]; room conditions 24°C bs; 50% R.H. (17°C bu)

2 Measured in the front part at 1 m height, 2 m distance, referred to free field, with working fans and compressor.

ATTENTION: the refrigerating outputs are meant after deduction of the heat taken from the fans, which must thus be added to the room load. The EER refers only to the room unit. The unit air flow refers in standard configuration with clean class filter G3.

Technical data and performances—water condensation—xxUW series, downward flow – 50Hz

MODEL		5SUW	5LUW	7SUW	7LUW	9SUW	9LUW
power supply voltage	V/ph/Hz	400/3/50	400/3/50	400/3/50	400/3/50	400/3/50	400/3/50
PERFORMANCES (1)							
air flow	m ³ /s	0.92	1.28	1.48	1.60	2.42	2.62
available head	Pa	20	20	20	20	20	20
fans absorbed power	kW	0.6	1.2	0.8	1.0	1.8	2.4
each fans absorbed current	A	1.4	2.6	2.6	3.3	4.5	5.4
sound pressure level (2)	dB(A)	49.9	53.1	53.0	54.3	53.3	55.6
condenser inlet water temperature: 15°C; condensation temperature: 40°C							
total cooling capacity	kW	11.4	16.8	21.0	24.2	27.0	33.6
sensible cooling capacity	kW	10.2	14.6	18.4	21.4	27.0	31.0
full absorbed power (fans and compressors)	kW	3.2	2.8	5.2	6.2	7.0	9.0
compressors absorbed power	kW	2.4	3.6	4.4	5.2	5.2	6.4
each compressors absorbed current	A	5.9	3.5	4.2	5.6	5.6	7.0
SHR (Sensible Heat Ratio)	–	0.89	0.87	0.88	0.89	1.00	0.92
EER (Energy Efficiency Ratio)	–	3.60	3.54	4.03	3.93	3.83	3.76
water flow	l/s	0.10	0.16	0.18	0.22	0.26	0.34
water pressure drop	kPa	1	2	1	2	2	3
condenser inlet water temperature: 30°C; condensation temperature: 45°C							
total cooling capacity	kW	11.0	16.2	20.4	23.4	26.6	32.4
sensible cooling capacity	kW	10.0	14.2	18.2	21.2	26.6	30.6
full absorbed power (fans and compressors)	kW	3.4	5.2	5.6	6.8	7.6	9.8
compressors absorbed power	kW	2.8	4.0	5.0	5.8	5.8	7.2
each compressors absorbed current	A	6.5	3.8	4.5	5.9	5.9	7.4
SHR (Sensible Heat Ratio)	–	0.91	0.88	0.89	0.91	1.00	0.94
EER (Energy Efficiency Ratio)	–	3.22	3.13	3.59	3.46	3.47	3.34
water flow	l/s	0.22	0.38	0.40	0.50	0.58	0.78
water pressure drop	kPa	3	9	4	6	7	13
FANS							
quantity	no.	2	2	2	2	2	2
type	–	dd 9/9	dd 9/9	dd 10/10	dd 10/10	dd 12/12	dd 12/12
speed	no.	3	3	3	3	3	3
nominal power	kW	0.245	0.420	0.500	0.500	0.736	0.736
poles	no.	6	4	6	6	6	6
COMPRESSORS							
quantity/type		2/scroll					
nominal power for each compressor	HP	1.90	2.50	3.25	4.00	4.00	5.00
refrigerant		R22	R22	R22	R22	R22	R22
EVAPORATING COIL							
pipes/fins		copper/aluminium			copper/treated aluminium		
fins for inch/rows	no.	12/3	12/3	12/4	12/4	12/5	12/5
front surface single coil	m ²	0.33	0.33	0.50	0.50	0.50	0.50
position/quantity		inclined/2					
CONDENSER							
quantity/type	–	2/plate					
water connections	inch	1/2" BSP					
DIMENSIONS							
length	mm	1490	1490	1490	1490	1490	1490
depth	mm	450	450	600	600	750	750
height	mm	1950	1950	1950	1950	1950	1950
plan surface	m ²	0.67	0.67	0.89	0.89	1.12	1.12
WEIGHTS							
net	kg	355	385	405	435	555	585
gross	kg	375	405	425	455	575	605

1 ON THE FOLLOWING STANDARD CONDITIONS: standard supply [voltage ± 10%]; room conditions 24°C bs; 50% R.H. (17°C bu)

2 Measured in the front part at 1 m height, 2 m distance, referred to free field, with working fans and compressor.

ATTENTION: the refrigerating outputs are meant after deduction of the heat taken from the fans, which must thus be added to the room load. The EER refers only to the room unit. The unit air flow refers in standard configuration with clean class filter G3.

Technical data and performances—water condensation—xxUW series, downward flow—60Hz

MODEL		4SUW	4LUW	6SUW	6LUW	8SUW	8LUW
power supply voltage	V/ph/Hz	208–230/1/60	200–230/3/60	200–230/3/60	380/3/60	380/3/60	380/3/60
PERFORMANCES (1)							
air flow	m ³ /s	0.55	0.64	0.81	0.90	1.12	1.37
available head	Pa	20	20	20	20	20	20
fan absorbed power	kW	0.5	1.0	0.7	0.8	1.3	1.6
fan absorbed current	A	2.3	4.3	3.7	4.0	5.9	7.1
sound pressure level (2)	dB(A)	49.8	49.4	51.5	54.9	47.6	53.1
condenser inlet water temperature: 15 °C; condensation temperature: 40 °C							
total cooling capacity	kW	6.8	9.7	12.4	14.4	16.0	19.7
sensible cooling capacity	kW	5.9	7.9	10.3	12.2	14.1	16.9
full absorbed power (fan and compressor)	kW	1.9	3.2	3.4	4.0	4.4	5.5
compressor absorbed power	kW	1.5	2.2	2.7	3.2	3.2	3.9
compressor absorbed current	A	5.9	6.1	7.3	5.6	5.6	7.0
SHR (Sensible Heat Ratio)	–	0.87	0.81	0.83	0.85	0.88	0.86
EER (Energy Efficiency Ratio)	–	3.48	3.02	3.65	3.64	3.62	3.60
water flow	l/s	0.06	0.10	0.12	0.14	0.16	0.20
water pressure drop	kPa	1	3	2	2	3	4
condenser inlet water temperature: 30 °C; condensation temperature: 45 °C							
total cooling capacity	kW	6.5	9.4	12.0	14.0	15.5	19.1
sensible cooling capacity	kW	5.8	7.7	10.1	12.1	13.9	16.7
full absorbed power (fan and compressor)	kW	2.1	3.5	3.7	4.3	4.8	5.9
compressor absorbed power	kW	1.7	2.5	3.0	3.5	3.5	4.3
compressor absorbed current	A	6.5	6.6	7.9	5.9	5.9	7.4
SHR (Sensible Heat Ratio)	–	0.88	0.83	0.85	0.86	0.90	0.88
EER (Energy Efficiency Ratio)	–	3.09	2.68	3.25	3.25	3.23	3.21
water flow	l/s	0.14	0.24	0.26	0.32	0.36	0.50
water pressure drop	kPa	5	14	6	9	12	22
FANS							
quantity	no.	1	1	1	1	1	1
type	–	dd 9/9	dd 9/9	dd 10/10	dd 10/10	dd 12/12	dd 12/12
speed	no.	3	3	3	3	3	3
nominal power	kW	0.245	0.420	0.500	0.500	0.736	0.736
poles	no.	6	4	6	6	6	6
COMPRESSOR							
quantity/type				1/scroll			
nominal power for each compressor	HP	1.90	2.50	3.25	4.00	4.00	5.00
refrigerant		R22	R22	R22	R22	R22	R22
EVAPORATING COIL							
pipes/fins		copper/aluminium		copper/treated aluminium			
fins for inch/rows	no.	12/3	12/3	12/4	12/4	12/5	12/5
front surface	m ²	0.33	0.33	0.50	0.50	0.50	0.50
position/quantity		inclined/1					
CONDENSER							
quantity/type	–	1/plate					
water connections	inch	½" BSP					
DIMENSIONS							
length	mm	750	750	750	750	750	750
depth	mm	450	450	600	600	750	750
height	mm	1950	1950	1950	1950	1950	1950
plan surface	m ²	0.34	0.34	0.45	0.45	0.56	0.56
WEIGHTS							
net	kg	185	200	210	225	285	300
gross	kg	195	210	220	235	295	310

1 ON THE FOLLOWING STANDARD CONDITIONS: standard supply [voltage ± 10%]; room conditions 24°C bs; 50% R.H. (17°C bu)

2 Measured in the front part at 1 m height, 2 m distance, referred to free field, with working fans and compressor.

ATTENTION: the refrigerating outputs are meant after deduction of the heat taken from the fans, which must thus be added to the room load. The EER refers only to the room unit. The unit air flow refers in standard configuration with clean class filter G3.

Technical data and performances—water condensation—xxUW series, downward flow—60Hz

MODEL		5SUW	5LUW	7SUW	7LUW	9SUW	9LUW
power supply voltage	V/ph/Hz	208–230/1/60	200–230/3/60	200–230/3/60	380/3/60	380/3/60	380/3/60
PERFORMANCES (1)							
air flow	m ³ /s	1.10	1.28	1.62	1.80	2.24	2.74
available head	Pa	20	20	20	20	20	20
fans absorbed power	kW	1.0	2.0	1.4	1.6	2.6	3.2
each fans absorbed current	A	2.3	4.3	3.7	4.0	5.9	7.1
sound pressure level (2)	dB(A)	52.8	52.4	54.5	57.9	50.6	56.1
condenser inlet water temperature: 15 °C; condensation temperature: 40 °C							
total cooling capacity	kW	13.6	19.4	24.8	28.8	32.0	39.4
sensible cooling capacity	kW	11.8	15.8	20.6	24.4	28.2	33.8
full absorbed power (fans and compressors)	kW	3.8	6.4	6.8	8.0	8.8	11.0
compressors absorbed power	kW	3.0	4.4	5.4	6.4	6.4	7.8
each compressors absorbed current	A	5.9	6.1	7.3	5.6	5.6	7.0
SHR (Sensible Heat Ratio)	–	0.87	0.81	0.83	0.85	0.88	0.86
EER (Energy Efficiency Ratio)	–	3.48	3.02	3.65	3.64	3.62	3.60
water flow	l/s	0.12	0.20	0.24	0.28	0.32	0.40
water pressure drop	kPa	1	3	2	2	3	4
condenser inlet water temperature: 30 °C; condensation temperature: 45 °C							
total cooling capacity	kW	13.0	18.8	24.0	28.0	31.0	38.2
sensible cooling capacity	kW	11.6	15.4	20.2	24.2	27.8	33.4
full absorbed power (fans and compressors)	kW	4.2	7.0	7.4	8.6	9.6	11.8
compressors absorbed power	kW	3.4	5.0	6.0	7.0	7.0	8.6
each compressors absorbed current	A	6.5	6.6	7.9	5.9	5.9	7.4
SHR (Sensible Heat Ratio)	–	0.88	0.83	0.85	0.86	0.90	0.88
EER (Energy Efficiency Ratio)	–	3.09	2.68	3.25	3.25	3.23	3.21
water flow	l/s	0.28	0.48	0.52	0.64	0.72	1.00
water pressure drop	kPa	5	14	6	9	12	22
FANS							
quantity	no.	2	2	2	2	2	2
type	–	dd 9/9	dd 9/9	dd 10/10	dd 10/10	dd 12/12	dd 12/12
speed	no.	3	3	3	3	3	3
nominal power	kW	0.245	0.420	0.500	0.500	0.736	0.736
poles	no.	6	4	6	6	6	6
COMPRESSORS							
quantity/type				2/scroll			
nominal power for each compressor	HP	1.90	2.50	3.25	4.00	4.00	5.00
refrigerant		R22	R22	R22	R22	R22	R22
EVAPORATING COIL							
pipes/fins		copper/aluminium			copper/treated aluminium		
fins for inch/rows	no.	12/3	12/3	12/4	12/4	12/5	12/5
front surface single coil	m ²	0.33	0.33	0.50	0.50	0.50	0.50
position/quantity		inclined/2					
CONDENSER							
quantity/type	–	2/plate					
water connections	inch	1/2" BSP					
DIMENSIONS							
length	mm	1490	1490	1490	1490	1490	1490
depth	mm	450	450	600	600	750	750
height	mm	1950	1950	1950	1950	1950	1950
plan surface	m ²	0.67	0.67	0.89	0.89	1.12	1.12
WEIGHTS							
net	kg	355	385	405	435	555	585
gross	kg	375	405	425	455	575	605

1 ON THE FOLLOWING STANDARD CONDITIONS: standard supply [voltage \pm 10%]; room conditions 24°C bs; 50% R.H. (17°C bu)

2 Measured in the front part at 1 m height, 2 m distance, referred to free field, with working fans and compressor.

ATTENTION: the refrigerating outputs are meant after deduction of the heat taken from the fans, which must thus be added to the room load. The EER refers only to the room unit. The unit air flow refers in standard configuration with clean class filter G3.

Technical data and performances—water condensation —xxOW series, upward flow—50Hz

MODEL		4POW	4GOW	6POW	6GOW	8POW	8GOW
power supply voltage	V/ph/Hz	400/3/50	400/3/50	400/3/50	400/3/50	400/3/50	400/3/50
PERFORMANCES (1)							
air flow	m ³ /s	0.40	0.59	0.68	0.73	1.08	1.13
available head	Pa	50	50	50	50	50	50
fan absorbed power	kW	0.3	0.5	0.3	0.5	0.8	1.1
fan absorbed current	A	1.2	2.5	2.2	3.1	3.9	4.7
sound pressure level (2)	dB(A)	47.0	52.3	53.0	54.2	53.8	55.3
condenser inlet water temperature: 15°C; condensation temperature: 40°C							
total cooling capacity	kW	5.5	8.3	10.4	12.4	13.7	16.5
sensible cooling capacity	kW	4.8	7.0	9.1	10.5	13.0	14.4
full absorbed power (fan and compressor)	kW	1.6	2.4	2.6	3.3	3.6	4.5
compressor absorbed power	kW	1.3	1.9	2.2	2.8	2.8	3.4
compressor absorbed current	A	6.1	3.9	4.4	5.6	5.7	7.2
SHR (Sensible Heat Ratio)	—	0.87	0.84	0.87	0.84	0.94	0.87
EER (Energy Efficiency Ratio)	—	3.42	3.44	4.06	3.81	3.83	3.67
water flow	l/s	0.05	0.08	0.09	0.12	0.13	0.16
water pressure drop	kPa	1	2	1	2	2	3
condenser inlet water temperature: 30°C; condensation temperature: 45°C							
total cooling capacity	kW	5.3	8.0	10.0	11.9	13.1	15.8
sensible cooling capacity	kW	4.7	6.9	8.9	10.2	12.7	14.1
full absorbed power (fan and compressor)	kW	1.8	2.7	2.9	3.6	3.9	4.9
compressor absorbed power	kW	1.5	2.2	2.5	3.1	3.1	3.8
compressor absorbed current	A	6.8	4.2	4.8	6.0	6.0	7.6
SHR (Sensible Heat Ratio)	—	0.89	0.86	0.89	0.86	0.97	0.89
EER (Energy Efficiency Ratio)	—	2.99	3.01	3.51	3.30	3.34	3.22
water flow	l/s	0.10	0.19	0.19	0.26	0.29	0.39
water pressure drop	kPa	3	9	4	6	8	3
FANS							
quantity	no.	1	1	1	1	1	1
type	—	dd 9/9	dd 9/9	dd 10/10	dd 10/10	dd 12/12	dd 12/12
speed	no.	3	3	3	3	3	3
nominal power	kW	0.245	0.420	0.500	0.500	0.736	0.736
poles	no.	6	4	6	6	6	6
COMPRESSOR							
quantity/type					1/scroll		
nominal power for each compressor	HP	1.90	2.50	3.25	4.00	4.00	5.00
refrigerant		R407C	R407C	R407C	R407C	R407C	R407C
EVAPORATING COIL							
pipes/fins		copper/aluminium		copper/treated aluminium			
fins for inch/rows	no.	12/3	12/3	12/4	12/4	12/5	12/5
front surface	m ²	0.33	0.33	0.50	0.50	0.50	0.50
position/quantity		inclined/1					
CONDENSER							
quantity/type	—	1/plate					
water connections	inch	½" BSP					
DIMENSIONS							
length	mm	750	750	750	750	750	750
depth	mm	450	450	600	600	750	750
height	mm	1950	1950	1950	1950	1950	1950
plan surface	m ²	0.34	0.34	0.45	0.45	0.56	0.56
WEIGHTS							
net	kg	185	200	210	225	285	300
gross	kg	195	210	220	235	295	310

1 ON THE FOLLOWING STANDARD CONDITIONS: standard supply [voltage ± 10%]; room conditions 24°C bs; 50% R.H. (17°C bu)

2 Measured in the front part at 1 m height, 2 m distance, referred to free field, with working fans and compressor.

ATTENTION: the refrigerating outputs are meant after deduction of the heat taken from the fans, which must thus be added to the room load. The EER refers only to the room unit. The unit air flow refers in standard configuration with clean class filter G3.

Technical data and performances—water condensation —xxOW series, upward flow—50Hz

MODEL		5POW	5GOW	7POW	7GOW	9POW	9GOW
power supply voltage	V/ph/Hz	400/3/50	400/3/50	400/3/50	400/3/50	400/3/50	400/3/50
PERFORMANCES (1)							
air flow	m ³ /s	0.80	1.18	1.36	1.46	2.16	2.26
available head	Pa	50	50	50	50	50	50
fans absorbed power	kW	0.6	1.0	0.6	1.0	1.6	2.2
each fans absorbed current	A	1.2	2.5	2.2	3.1	3.9	4.7
sound pressure level (2)	dB(A)	50.0	55.3	55.0	57.2	57.8	58.3
condenser inlet water temperature: 15°C; condensation temperature: 40°C							
total cooling capacity	kW	11.0	16.6	20.8	24.8	27.4	33.0
sensible cooling capacity	kW	9.6	14.0	18.2	21.0	26.0	28.8
full absorbed power (fans and compressors)	kW	3.2	4.8	5.2	6.6	7.2	9.0
compressors absorbed power	kW	2.6	3.8	4.4	5.6	5.6	6.8
each compressors absorbed current	A	6.1	3.9	4.4	5.6	5.7	7.2
SHR (Sensible Heat Ratio)	—	0.87	0.84	0.87	0.84	0.94	0.87
EER (Energy Efficiency Ratio)	—	3.42	3.44	4.06	3.81	3.83	3.67
water flow	l/s	0.10	0.16	0.18	0.24	0.26	0.32
water pressure drop	kPa	1	2	1	2	2	3
condenser inlet water temperature: 30°C; condensation temperature: 45°C							
total cooling capacity	kW	10.6	16.0	20.0	23.8	26.2	31.6
sensible cooling capacity	kW	9.4	13.8	17.8	20.4	25.4	28.2
full absorbed power (fans and compressors)	kW	3.6	5.4	5.8	7.2	7.8	9.8
compressors absorbed power	kW	3.0	4.4	5.0	6.2	6.2	7.6
each compressors absorbed current	A	6.8	4.2	4.8	6.0	6.0	7.6
SHR (Sensible Heat Ratio)	—	0.89	0.86	0.89	0.86	0.97	0.89
EER (Energy Efficiency Ratio)	—	2.99	3.01	3.51	3.30	3.34	3.22
water flow	l/s	0.20	0.38	0.38	0.52	0.58	0.78
water pressure drop	kPa	3	9	4	6	8	3
FANS							
quantity	no.	2	2	2	2	2	2
type	—	dd 9/9	dd 9/9	dd 10/10	dd 10/10	dd 12/12	dd 12/12
speed	no.	3	3	3	3	3	3
nominal power	kW	0.245	0.420	0.500	0.500	0.736	0.736
poles	no.	6	4	6	6	6	6
COMPRESSORS							
quantity/type				2/scroll			
nominal power for each compressor	HP	1.90	2.50	3.25	4.00	4.00	5.00
refrigerant		R407C	R407C	R407C	R407C	R407C	R407C
EVAPORATING COIL							
pipes/fins		copper/aluminium			copper/treated aluminium		
fins for inch/rows	no.	12/3	12/3	12/4	12/4	12/5	12/5
front surface single coil	m ²	0.33	0.33	0.50	0.50	0.50	0.50
position/quantity		inclined/2					
CONDENSER							
quantity/type	—	2/plate					
water connections	inch	½" BSP					
DIMENSIONS							
length	mm	1490	1490	1490	1490	1490	1490
depth	mm	450	450	600	600	750	750
height	mm	1950	1950	1950	1950	1950	1950
plan surface	m ²	0.67	0.67	0.89	0.89	1.12	1.12
WEIGHTS							
net	kg	355	385	405	435	555	585
gross	kg	375	405	425	455	575	605

1 ON THE FOLLOWING STANDARD CONDITIONS: standard supply [voltage ± 10%]; room conditions 24°C bs; 50% R.H. (17°C bu)

2 Measured in the front part at 1 m height, 2 m distance, referred to free field, with working fans and compressor.

ATTENTION: the refrigerating outputs are meant after deduction of the heat taken from the fans, which must thus be added to the room load. The EER refers only to the room unit. The unit air flow refers in standard configuration with clean class filter G3.

Technical data and performances—water condensation —xxOW series, upward flow—60Hz

MODEL		4POW	4GOW	6POW	6GOW	8POW	8GOW
power supply voltage	V/ph/Hz	208–230/1 /60	200–230/3 /60	200–230/3 /60	380/3/60	380/3/60	380/3/60
PERFORMANCES (1)							
air flow	m ³ /s	0.40	0.59	0.68	0.73	1.08	1.13
available head	Pa	50	50	50	50	50	50
fan absorbed power	kW	0.3	0.5	0.3	0.5	0.8	1.0
fan absorbed current	A	2.1	4.1	3.3	3.7	5.1	6.2
sound pressure level (2)	dB(A)	49.4	51.7	54.7	59.7	50.9	55.9
condenser inlet water temperature: 15°C; condensation temperature: 40°C							
total cooling capacity	kW	6.7	9.6	12.3	14.8	15.9	19.6
sensible cooling capacity	kW	5.7	7.7	10.4	12.1	13.6	16.4
full absorbed power (fan and compressor)	kW	1.9	2.8	3.0	3.8	4.1	5.0
compressor absorbed power	kW	1.6	2.3	2.7	3.3	3.3	4.1
compressor absorbed current	A	6.1	6.8	7.6	5.6	5.6	7.2
SHR (Sensible Heat Ratio)	–	0.85	0.80	0.84	0.82	0.85	0.84
EER (Energy Efficiency Ratio)	–	3.56	3.44	4.08	3.88	3.85	3.88
water flow	l/s	0.06	0.10	0.11	0.14	0.16	0.20
water pressure drop	kPa	1	3	2	2	3	4
condenser inlet water temperature: 30°C; condensation temperature: 45°C							
total cooling capacity	kW	6.4	9.3	11.9	14.1	15.3	18.7
sensible cooling capacity	kW	5.6	7.6	10.2	11.8	13.4	16.1
full absorbed power (fan and compressor)	kW	2.1	3.1	3.4	4.2	4.6	5.5
compressor absorbed power	kW	1.8	2.6	3.0	3.7	3.7	4.6
compressor absorbed current	A	6.8	7.3	8.3	6.0	6.0	7.6
SHR (Sensible Heat Ratio)	–	0.87	0.81	0.86	0.84	0.87	0.86
EER (Energy Efficiency Ratio)	–	3.08	3.00	3.54	3.33	3.36	3.39
water flow	l/s	0.14	0.24	0.25	0.33	0.37	0.50
water pressure drop	kPa	5	14	6	10	12	22
FANS							
quantity	no.	1	1	1	1	1	1
type	–	dd 9/9	dd 9/9	dd 10/10	dd 10/10	dd 12/12	dd 12/12
speed	no.	3	3	3	3	3	3
nominal power	kW	0.245	0.420	0.500	0.500	0.736	0.736
poles	no.	6	4	6	6	6	6
COMPRESSOR							
quantity/type					1/scroll		
nominal power for each compressor	HP	1.90	2.50	3.25	4.00	4.00	5.00
refrigerant		R407C	R407C	R407C	R407C	R407C	R407C
EVAPORATING COIL							
pipes/fins		copper/aluminium			copper/treated aluminium		
fins for inch/rows	no.	12/3	12/3	12/4	12/4	12/5	12/5
front surface	m ²	0.33	0.33	0.50	0.50	0.50	0.50
position/quantity		inclined/1					
CONDENSER							
quantity/type	–	1/plate					
water connections	inch	½" BSP					
DIMENSIONS							
length	mm	750	750	750	750	750	750
depth	mm	450	450	600	600	750	750
height	mm	1950	1950	1950	1950	1950	1950
plan surface	m ²	0.34	0.34	0.45	0.45	0.56	0.56
WEIGHTS							
net	kg	185	200	210	225	285	300
gross	kg	195	210	220	235	295	310

1 ON THE FOLLOWING STANDARD CONDITIONS: standard supply [voltage ± 10%]; room conditions 24°C bs; 50% R.H. (17°C bu)

2 Measured in the front part at 1 m height, 2 m distance, referred to free field, with working fans and compressor.

ATTENTION: the refrigerating outputs are meant after deduction of the heat taken from the fans, which must thus be added to the room load. The EER refers only to the room unit. The unit air flow refers in standard configuration with clean class filter G3.

Technical data and performances—water condensation —xxOW series, upward flow—60Hz

MODEL		5POW	5GOW	7POW	7GOW	9POW	9GOW
power supply voltage	V/ph/Hz	208–230/1/60	200–230/3/60	200–230/3/60	380/3/60	380/3/60	380/3/60
PERFORMANCES (1)							
air flow	m ³ /s	0.80	1.18	1.36	1.46	2.16	2.26
available head	Pa	50	50	50	50	50	50
fans absorbed power	kW	0.6	1.0	0.6	1.0	1.6	2.0
each fans absorbed current	A	2.1	4.1	3.3	3.7	5.1	6.2
sound pressure level (2)	dB(A)	52.4	54.7	57.7	62.7	53.9	58.9
condenser inlet water temperature: 15°C; condensation temperature: 40°C							
total cooling capacity	kW	13.4	19.2	24.6	29.6	31.8	39.2
sensible cooling capacity	kW	11.4	15.4	20.8	24.2	27.2	32.8
full absorbed power (fans and compressors)	kW	3.8	5.6	6.0	7.6	8.2	10.0
compressors absorbed power	kW	3.2	4.6	5.4	6.6	6.6	8.2
each compressors absorbed current	A	6.1	6.8	7.6	5.6	5.6	7.2
SHR (Sensible Heat Ratio)	–	0.85	0.80	0.84	0.82	0.85	0.84
EER (Energy Efficiency Ratio)	–	3.56	3.44	4.08	3.88	3.85	3.88
water flow	l/s	0.12	0.20	0.22	0.28	0.32	0.40
water pressure drop	kPa	1	3	2	2	3	4
condenser inlet water temperature: 30°C; condensation temperature: 45°C							
total cooling capacity	kW	12.8	18.6	23.8	28.2	30.6	37.4
sensible cooling capacity	kW	11.2	15.2	20.4	23.6	26.8	32.2
full absorbed power (fans and compressors)	kW	4.2	6.2	6.8	8.4	9.2	11.0
compressors absorbed power	kW	3.6	5.2	6.0	7.4	7.4	9.2
each compressors absorbed current	A	6.8	7.3	8.3	6.0	6.0	7.6
SHR (Sensible Heat Ratio)	–	0.87	0.81	0.86	0.84	0.87	0.86
EER (Energy Efficiency Ratio)	–	3.08	3.00	3.54	3.33	3.36	3.39
water flow	l/s	0.28	0.48	0.50	0.66	0.74	1.00
water pressure drop	kPa	5	14	6	10	12	22
FANS							
quantity	no.	2	2	2	2	2	2
type	–	dd 9/9	dd 9/9	dd 10/10	dd 10/10	dd 12/12	dd 12/12
speed	no.	3	3	3	3	3	3
nominal power	kW	0.245	0.420	0.500	0.500	0.736	0.736
poles	no.	6	4	6	6	6	6
COMPRESSORS							
quantity/type		2/scroll					
nominal power for each compressor	HP	1.90	2.50	3.25	4.00	4.00	5.00
refrigerant		R407C	R407C	R407C	R407C	R407C	R407C
EVAPORATING COIL							
pipes/fins		copper/aluminium		copper/treated aluminium			
fins for inch/rows	no.	12/3	12/3	12/4	12/4	12/5	12/5
front surface single coil	m ²	0.33	0.33	0.50	0.50	0.50	0.50
position/quantity		inclined/2					
CONDENSER							
quantity/type	–	2/plate					
water connections	inch	1/2" BSP					
DIMENSIONS							
length	mm	1490	1490	1490	1490	1490	1490
depth	mm	450	450	600	600	750	750
height	mm	1950	1950	1950	1950	1950	1950
plan surface	m ²	0.67	0.67	0.89	0.89	1.12	1.12
WEIGHTS							
net	kg	355	385	405	435	555	585
gross	kg	375	405	425	455	575	605

1 ON THE FOLLOWING STANDARD CONDITIONS: standard supply [voltage \pm 10%]; room conditions 24°C bs; 50% R.H. (17°C bu)

2 Measured in the front part at 1 m height, 2 m distance, referred to free field, with working fans and compressor.

ATTENTION: the refrigerating outputs are meant after deduction of the heat taken from the fans, which must thus be added to the room load. The EER refers only to the room unit. The unit air flow refers in standard configuration with clean class filter G3.

Technical data and performances—water condensation —xxOW series, downward flow—50Hz

MODEL		4SOW	4LOW	6SOW	6LOW	8SOW	8LOW
power supply voltage	V/ph/Hz	400/3/50	400/3/50	400/3/50	400/3/50	400/3/50	400/3/50
PERFORMANCES (1)							
air flow	m ³ /s	0.40	0.59	0.68	0.73	1.08	1.13
available head	Pa	50	50	50	50	50	50
fan absorbed power	kW	0.3	0.5	0.3	0.5	0.8	1.1
fan absorbed current	A	1.2	2.5	2.2	3.1	3.9	4.7
sound pressure level (2)	dB(A)	47.0	52.3	53.0	54.2	53.8	55.3
condenser inlet water temperature: 15°C; condensation temperature: 40°C							
total cooling capacity	kW	5.4	8.1	10.3	11.8	13.5	16.4
sensible cooling capacity	kW	4.7	6.9	9.2	10.3	13.0	14.4
full absorbed power (fan and compressor)	kW	1.6	2.3	2.6	3.1	3.5	4.3
compressor absorbed power	kW	1.2	1.8	2.2	2.6	2.6	3.2
compressor absorbed current	A	5.9	3.5	4.2	5.6	5.6	7.0
SHR (Sensible Heat Ratio)	—	0.88	0.86	0.89	0.87	0.96	0.88
EER (Energy Efficiency Ratio)	—	3.43	3.48	3.99	3.78	3.90	3.78
water flow	l/s	0.05	0.08	0.09	0.11	0.12	0.16
water pressure drop	kPa	1	2	1	2	2	3
condenser inlet water temperature: 30°C; condensation temperature: 45°C							
total cooling capacity	kW	5.2	7.8	9.9	11.5	13.0	15.8
sensible cooling capacity	kW	4.7	6.8	9.0	10.1	12.8	14.1
full absorbed power (fan and compressor)	kW	1.7	2.6	2.8	3.4	3.8	4.7
compressor absorbed power	kW	1.4	2.0	2.5	2.9	2.9	3.6
compressor absorbed current	A	6.5	3.8	4.5	5.9	5.9	7.4
SHR (Sensible Heat Ratio)	—	0.89	0.87	0.91	0.88	0.98	0.89
EER (Energy Efficiency Ratio)	—	3.05	3.05	3.56	3.35	3.46	3.35
water flow	l/s	0.10	0.18	0.19	0.24	0.28	0.38
water pressure drop	kPa	3	8	4	5	7	13
FANS							
quantity	no.	1	1	1	1	1	1
type	—	dd 9/9	dd 9/9	dd 10/10	dd 10/10	dd 12/12	dd 12/12
speed	no.	3	3	3	3	3	3
nominal power	kW	0.245	0.420	0.500	0.500	0.736	0.736
poles	no.	6	4	6	6	6	6
COMPRESSOR							
quantity/type					1/scroll		
nominal power for each compressor	HP	1.90	2.50	3.25	4.00	4.00	5.00
refrigerant		R22	R22	R22	R22	R22	R22
EVAPORATING COIL							
pipes/fins		copper/aluminium			copper/treated aluminium		
fins for inch/rows	no.	12/3	12/3	12/4	12/4	12/5	12/5
front surface	m ²	0.33	0.33	0.50	0.50	0.50	0.50
position/quantity		inclined/1					
CONDENSER							
quantity/type	—	1/plate					
water connections	inch	½" BSP					
DIMENSIONS							
length	mm	750	750	750	750	750	750
depth	mm	450	450	600	600	750	750
height	mm	1950	1950	1950	1950	1950	1950
plan surface	m ²	0.34	0.34	0.45	0.45	0.56	0.56
WEIGHTS							
net	kg	185	200	210	225	285	300
gross	kg	195	210	220	235	295	310

1 ON THE FOLLOWING STANDARD CONDITIONS: standard supply [voltage ± 10%]; room conditions 24°C bs; 50% R.H. (17°C bu)

2 Measured in the front part at 1 m height, 2 m distance, referred to free field, with working fans and compressor.

ATTENTION: the refrigerating outputs are meant after deduction of the heat taken from the fans, which must thus be added to the room load. The EER refers only to the room unit. The unit air flow refers in standard configuration with clean class filter G3.

Technical data and performances—water condensation —xxOW series, downward flow—50Hz

MODEL		5SOW	5LOW	7SOW	7LOW	9SOW	9LOW
power supply voltage	V/ph/Hz	400/3/50	400/3/50	400/3/50	400/3/50	400/3/50	400/3/50
PERFORMANCES (1)							
air flow	m ³ /s	0.80	1.18	1.36	1.46	2.16	2.26
available head	Pa	50	50	50	50	50	50
fans absorbed power	kW	0.6	1.0	0.6	1.0	1.6	2.2
each fans absorbed current	A	1.2	2.5	2.2	3.1	3.9	4.7
sound pressure level (2)	dB(A)	50.0	55.3	56.0	57.2	57.8	58.3
condenser inlet water temperature: 15°C; condensation temperature: 40°C							
total cooling capacity	kW	10.8	16.2	20.6	23.6	27.0	32.8
sensible cooling capacity	kW	9.4	13.8	18.4	20.6	26.0	28.8
full absorbed power (fans and compressors)	kW	3.2	4.6	5.2	6.2	7.0	8.6
compressors absorbed power	kW	2.4	3.6	4.4	5.2	5.2	6.4
each compressors absorbed current	A	5.9	3.5	4.2	5.6	5.6	7.0
SHR (Sensible Heat Ratio)	—	0.88	0.86	0.89	0.87	0.96	0.88
EER (Energy Efficiency Ratio)	—	3.43	3.48	3.99	3.78	3.90	3.78
water flow	l/s	0.10	0.16	0.18	0.22	0.24	0.32
water pressure drop	kPa	1	2	1	2	2	3
condenser inlet water temperature: 30°C; condensation temperature: 45°C							
total cooling capacity	kW	10.4	15.6	19.8	23.0	26.0	31.6
sensible cooling capacity	kW	9.4	13.6	18.0	20.2	25.6	28.2
full absorbed power (fans and compressors)	kW	3.4	5.2	5.6	6.8	7.6	9.4
compressors absorbed power	kW	2.8	4.0	5.0	5.8	5.8	7.2
each compressors absorbed current	A	6.5	3.8	4.5	5.9	5.9	7.4
SHR (Sensible Heat Ratio)	—	0.89	0.87	0.91	0.88	0.98	0.89
EER (Energy Efficiency Ratio)	—	3.05	3.05	3.56	3.35	3.46	3.35
water flow	l/s	0.20	0.36	0.38	0.48	0.48	0.76
water pressure drop	kPa	3	8	4	5	7	13
FANS							
quantity	no.	2	2	2	2	2	2
type	—	dd 9/9	dd 9/9	dd 10/10	dd 10/10	dd 12/12	dd 12/12
speed	no.	3	3	3	3	3	3
nominal power	kW	0.245	0.420	0.500	0.500	0.736	0.736
poles	no.	6	4	6	6	6	6
COMPRESSORS							
quantity/type					2/scroll		
nominal power for each compressor	HP	1.90	2.50	3.25	4.00	4.00	5.00
refrigerant		R22	R22	R22	R22	R22	R22
EVAPORATING COIL							
pipes/fins		copper/aluminium			copper/treated aluminium		
fins for inch/rows	no.	12/3	12/3	12/4	12/4	12/5	12/5
front surface single coil	m ²	0.33	0.33	0.50	0.50	0.50	0.50
position/quantity		inclined/2					
CONDENSER							
quantity/type	—	2/plate					
water connections	inch	½" BSP					
DIMENSIONS							
length	mm	1490	1490	1490	1490	1490	1490
depth	mm	450	450	600	600	750	750
height	mm	1950	1950	1950	1950	1950	1950
plan surface	m ²	0.67	0.67	0.89	0.89	1.12	1.12
WEIGHTS							
net	kg	355	385	405	435	555	585
gross	kg	375	405	425	455	575	605

1 ON THE FOLLOWING STANDARD CONDITIONS: standard supply [voltage ± 10%]; room conditions 24°C bs; 50% R.H. (17°C bu)

2 Measured in the front part at 1 m height, 2 m distance, referred to free field, with working fans and compressor.

ATTENTION: the refrigerating outputs are meant after deduction of the heat taken from the fans, which must thus be added to the room load. The EER refers only to the room unit. The unit air flow refers in standard configuration with clean class filter G3.

Technical data and performances—water condensation –xxOW series, upward flow—60Hz

MODEL		4SOW	4LOW	6SOW	6LOW	8SOW	8LOW
power supply voltage	V/ph/Hz	208–230/1 /60	200–230/3 /60	200–230/3 /60	380/3/60	380/3/60	380/3/60
PERFORMANCES (1)							
air flow	m ³ /s	0.50	0.61	0.77	0.85	1.05	1.28
available head	Pa	50	50	50	50	50	50
fan absorbed power	kW	0.5	1.0	0.7	0.8	1.1	1.4
fan absorbed current	A	2.1	4.1	3.3	3.7	5.1	6.2
sound pressure level (2)	dB(A)	49.4	51.7	54.7	59.7	50.9	55.9
condenser inlet water temperature: 15°C; condensation temperature: 40°C							
total cooling capacity	kW	6.5	9.5	12.2	14.1	15.7	19.5
sensible cooling capacity	kW	5.6	7.7	10.5	11.8	13.6	16.4
full absorbed power (fan and compressor)	kW	2.0	3.2	3.3	3.9	4.3	5.3
compressor absorbed power	kW	1.5	2.2	2.7	3.2	3.2	3.9
compressor absorbed current	A	5.9	6.1	7.3	5.6	5.6	7.0
SHR (Sensible Heat Ratio)	–	0.87	0.81	0.86	0.84	0.87	0.84
EER (Energy Efficiency Ratio)	–	3.29	2.96	3.66	3.59	3.66	3.67
water flow	l/s	0.06	0.10	0.11	0.14	0.15	0.20
water pressure drop	kPa	1	3	2	2	3	4
condenser inlet water temperature: 30°C; condensation temperature: 45°C							
total cooling capacity	kW	6.3	9.1	11.9	13.7	15.2	18.8
sensible cooling capacity	kW	5.5	7.5	10.3	11.6	13.4	16.1
full absorbed power (fan and compressor)	kW	2.1	3.5	3.6	4.3	4.6	5.8
compressor absorbed power	kW	1.7	2.5	3.0	3.5	3.5	4.3
compressor absorbed current	A	6.5	6.6	7.9	5.9	5.9	7.4
SHR (Sensible Heat Ratio)	–	0.88	0.82	0.87	0.85	0.88	0.86
EER (Energy Efficiency Ratio)	–	2.93	2.63	3.27	3.19	3.28	3.25
water flow	l/s	0.13	0.23	0.25	0.32	0.36	0.49
water pressure drop	kPa	5	13	6	9	12	21
FANS							
quantity	no.	1	1	1	1	1	1
type	–	dd 9/9	dd 9/9	dd 10/10	dd 10/10	dd 12/12	dd 12/12
speed	no.	3	3	3	3	3	3
nominal power	kW	0.245	0.420	0.500	0.500	0.736	0.736
poles	no.	6	4	6	6	6	6
COMPRESSOR							
quantity/type					1/scroll		
nominal power for each compressor	HP	1.90	2.50	3.25	4.00	4.00	5.00
refrigerant		R22	R22	R22	R22	R22	R22
EVAPORATING COIL							
pipes/fins		copper/aluminium			copper/treated aluminium		
fins for inch/rows	no.	12/3	12/3	12/4	12/4	12/5	12/5
front surface	m ²	0.33	0.33	0.50	0.50	0.50	0.50
position/quantity		inclined/1					
CONDENSER							
quantity/type	–	1/plate					
water connections	inch	½" BSP					
DIMENSIONS							
length	mm	750	750	750	750	750	750
depth	mm	450	450	600	600	750	750
height	mm	1950	1950	1950	1950	1950	1950
plan surface	m ²	0.34	0.34	0.45	0.45	0.56	0.56
WEIGHTS							
net	kg	185	200	210	225	285	300
gross	kg	195	210	220	235	295	310

1 ON THE FOLLOWING STANDARD CONDITIONS: standard supply [voltage \pm 10%]; room conditions 24°C bs; 50% R.H. (17°C bu)

2 Measured in the front part at 1 m height, 2 m distance, referred to free field, with working fans and compressor.

ATTENTION: the refrigerating outputs are meant after deduction of the heat taken from the fans, which must thus be added to the room load. The EER refers only to the room unit. The unit air flow refers in standard configuration with clean class filter G3.

Technical data and performances—water condensation —xxOW series, upward flow—60Hz

MODEL		5SOW	5LOW	7SOW	7LOW	9SOW	9LOW
power supply voltage	V/ph/Hz	208–230/1/60	200–230/3/60	200–230/3/60	380/3/60	380/3/60	380/3/60
PERFORMANCES (1)							
air flow	m ³ /s	1.00	1.22	1.54	1.70	2.10	2.56
available head	Pa	50	50	50	50	50	50
fans absorbed power	kW	1.0	2.0	1.4	1.6	2.2	2.8
each fans absorbed current	A	2.1	4.1	3.3	3.7	5.1	6.2
sound pressure level (2)	dB(A)	52.4	54.7	53.7	62.7	53.9	58.9
condenser inlet water temperature: 15°C; condensation temperature: 40°C							
total cooling capacity	kW	13.0	19.0	24.4	28.2	31.4	39.0
sensible cooling capacity	kW	11.2	15.4	21.0	23.6	27.2	32.8
full absorbed power (fans and compressors)	kW	4.0	6.4	6.6	7.8	8.6	10.6
compressors absorbed power	kW	3.0	4.4	5.4	6.4	6.4	7.8
each compressors absorbed current	A	5.9	6.1	7.3	5.6	5.6	7.0
SHR (Sensible Heat Ratio)	–	0.87	0.81	0.86	0.84	0.87	0.84
EER (Energy Efficiency Ratio)	–	3.29	2.96	3.66	3.59	3.66	3.67
water flow	l/s	0.12	0.20	0.22	0.28	0.30	0.40
water pressure drop	kPa	1	3	2	2	3	4
condenser inlet water temperature: 30°C; condensation temperature: 45°C							
total cooling capacity	kW	12.6	18.2	23.8	27.4	30.4	37.6
sensible cooling capacity	kW	11.0	15.0	20.6	23.2	26.8	32.2
full absorbed power (fans and compressors)	kW	4.2	7.0	7.2	8.6	9.2	11.6
compressors absorbed power	kW	3.4	5.0	6.0	7.0	7.0	8.6
each compressors absorbed current	A	6.5	6.6	7.9	5.9	5.9	7.4
SHR (Sensible Heat Ratio)	–	0.88	0.82	0.87	0.85	0.88	0.86
EER (Energy Efficiency Ratio)	–	2.93	2.63	3.27	3.19	3.28	3.25
water flow	l/s	0.26	0.46	0.50	0.64	0.72	0.98
water pressure drop	kPa	5	13	6	9	12	21
FANS							
quantity	no.	2	2	2	2	2	2
type	–	dd 9/9	dd 9/9	dd 10/10	dd 10/10	dd 12/12	dd 12/12
speed	no.	3	3	3	3	3	3
nominal power	kW	0.245	0.420	0.500	0.500	0.736	0.736
poles	no.	6	4	6	6	6	6
COMPRESSORS							
quantity/type					2/scroll		
nominal power for each compressor	HP	1.90	2.50	3.25	4.00	4.00	5.00
refrigerant		R22	R22	R22	R22	R22	R22
EVAPORATING COIL							
pipes/fins		copper/aluminium			copper/treated aluminium		
fins for inch/rows	no.	12/3	12/3	12/4	12/4	12/5	12/5
front surface single coil	m ²	0.33	0.33	0.50	0.50	0.50	0.50
position/quantity		inclined/2					
CONDENSER							
quantity/type	–	2/plate					
water connections	inch	½" BSP					
DIMENSIONS							
length	mm	1490	1490	1490	1490	1490	1490
depth	mm	450	450	600	600	750	750
height	mm	1950	1950	1950	1950	1950	1950
plan surface	m ²	0.67	0.67	0.89	0.89	1.12	1.12
WEIGHTS							
net	kg	355	385	405	435	555	585
gross	kg	375	405	425	455	575	605

1 ON THE FOLLOWING STANDARD CONDITIONS: standard supply [voltage ± 10%]; room conditions 24°C bs; 50% R.H. (17°C bu)

2 Measured in the front part at 1 m height, 2 m distance, referred to free field, with working fans and compressor.

ATTENTION: the refrigerating outputs are meant after deduction of the heat taken from the fans, which must thus be added to the room load. The EER refers only to the room unit. The unit air flow refers in standard configuration with clean class filter G3.

Technical data and performances—water condensation —xxCW series, upward flow—50Hz

MODEL		4PCW	4GCW	6PCW	8PCW
power supply voltage	V/ph/Hz	400/3/50	400/3/50	400/3/50	400/3/50
PERFORMANCES (1)					
air flow	m ³ /s	0.36	0.53	0.61	0.97
available head	Pa	50	50	50	50
fan absorbed power	kW	0.3	0.6	0.4	0.8
fan absorbed current	A	1.4	2.4	2.2	4.2
sound pressure level (2)	dB(A)	47.0	52.3	53.0	53.8
condenser inlet water temperature: 15 °C; condensation temperature: 40 °C					
total cooling capacity	kW	5.4	8.2	10.2	13.6
sensible cooling capacity	kW	4.6	6.7	8.7	12.3
full absorbed power (fan and compressor)	kW	1.6	2.5	2.6	3.6
compressor absorbed power	kW	1.3	1.9	2.2	2.8
compressor absorbed current	A	6.1	3.9	4.4	5.6
SHR (Sensible Heat Ratio)	—	0.84	0.81	0.85	0.90
EER (Energy Efficiency Ratio)	—	3.42	3.27	3.89	3.81
water flow	l/s	0.05	0.08	0.09	0.13
water pressure drop	kPa	1	2	1	2
condenser inlet water temperature: 30 °C; condensation temperature: 45 °C					
total cooling capacity	kW	5.2	7.9	9.9	13.0
sensible cooling capacity	kW	4.5	6.6	8.5	12.0
full absorbed power (fan and compressor)	kW	1.8	2.8	2.9	3.9
compressor absorbed power	kW	1.5	2.2	2.5	3.1
compressor absorbed current	A	6.8	4.2	4.8	6.0
SHR (Sensible Heat Ratio)	—	0.86	0.84	0.86	0.93
EER (Energy Efficiency Ratio)	—	2.97	2.85	3.38	3.32
water flow	l/s	0.10	0.19	0.19	0.28
water pressure drop	kPa	3	9	3	7
FANS					
quantity	no.	1	1	1	1
type	—	dd 9/9	dd 9/9	dd 10/10	dd 10/10
speed	no.	3	3	3	3
nominal power	kW	0.245	0.420	0.500	0.500
poles	no.	6	4	6	6
COMPRESSOR					
quantity/type		1/scroll			
nominal power for each compressor	HP	1.90	2.50	3.25	4.00
refrigerant		R407C	R407C	R407C	R407C
EVAPORATING COIL					
pipes/fins		copper/aluminium		copper/treated aluminium	
fins for inch/rows	no.	12/3	12/3	12/4	12/4
front surface	m ²	0.33	0.33	0.50	0.50
position/quantity		inclined/1			
CONDENSER					
quantity/type	—	1/plate			
water connections	inch	½" BSP			
DIMENSIONS					
length	mm	750	750	750	750
depth	mm	450	450	600	600
height	mm	1950	1950	1950	1950
plan surface	m ²	0.34	0.34	0.45	0.45
WEIGHTS					
net	kg				
gross	kg				

1 ON THE FOLLOWING STANDARD CONDITIONS: standard supply [voltage \pm 10%]; room conditions 24°C bs; 50% R.H. (17°C bu)

2 Measured in the front part at 1 m height, 2 m distance, referred to free field, with working fans and compressor.

ATTENTION: the refrigerating outputs are meant after deduction of the heat taken from the fans, which must thus be added to the room load. The EER refers only to the room unit. The unit air flow refers in standard configuration with clean class filter G3.

Technical data and performances—water condensation —xxCW series, upward flow—60Hz

MODEL		4PCW	4GCW	6PCW	8PCW
power supply voltage	V/ph/Hz	208–230/1/60	200–230/3/60	200–230/3/60	380/3/60
PERFORMANCES (1)					
air flow	m ³ /s	0.38	0.53	0.64	0.99
available head	Pa	0	50	50	50
fan absorbed power	kW	0.4	1.0	0.5	1.1
fan absorbed current	A	1.9	3.9	2.5	4.6
sound pressure level (2)	dB(A)	49.4	51.7	54.7	50.9
condenser inlet water temperature: 15°C; condensation temperature: 40°C					
total cooling capacity	kW	6.4	9.4	11.9	15.8
sensible cooling capacity	kW	5.1	7.3	9.6	13.3
full absorbed power (fan and compressor)	kW	2.0	3.3	3.2	4.4
compressor absorbed power	kW	1.6	2.3	2.7	3.3
compressor absorbed current	A	6.1	6.8	7.6	5.6
SHR (Sensible Heat Ratio)	–	0.79	0.77	0.80	0.84
EER (Energy Efficiency Ratio)	–	3.24	2.89	3.74	3.63
water flow	l/s	0.06	0.10	0.11	0.16
water pressure drop	kPa	0.93	2	1	2
condenser inlet water temperature: 30°C; condensation temperature: 45°C					
total cooling capacity	kW	6.1	9.1	11.5	15.2
sensible cooling capacity	kW	5.0	7.1	9.4	13.0
full absorbed power (fan and compressor)	kW	2.2	3.6	3.5	4.8
compressor absorbed power	kW	1.8	2.6	3.0	3.7
compressor absorbed current	A	6.8	7.3	8.3	6.0
SHR (Sensible Heat Ratio)	–	0.81	0.79	0.82	0.86
EER (Energy Efficiency Ratio)	–	2.83	2.55	3.25	3.18
water flow	l/s	0.13	0.23	0.24	0.36
water pressure drop	kPa	4.21	13	12	12
FANS					
quantity	no.	1	1	1	1
type	–	dd 9/9	dd 9/9	dd 10/10	dd 12/12
speed	no.	3	3	3	3
nominal power	kW	0.245	0.420	0.500	0.736
poles	no.	6	4	6	6
COMPRESSOR					
quantity/type				1/scroll	
nominal power for each compressor	HP	1.90	2.50	3.25	4.00
refrigerant		R407C	R407C	R407C	R407C
EVAPORATING COIL					
pipes/fins		copper/aluminium			copper/treated aluminium
fins for inch/rows	no.	12/3	12/3	12/4	12/5
front surface	m ²	0.33	0.33	0.33	0.50
position/quantity		inclined/1			
CONDENSER					
quantity/type	–	1/plate			
water connections	inch	½" BSP			
DIMENSIONS					
length	mm	750	750	750	750
depth	mm	450	450	600	750
height	mm	1950	1950	1950	1950
plan surface	m ²	0.34	0.34	0.45	0.56
WEIGHTS					
net	kg				
gross	kg				

1 ON THE FOLLOWING STANDARD CONDITIONS: standard supply [voltage \pm 10%]; room conditions 24°C bs; 50% R.H. (17°C bu)

2 Measured in the front part at 1 m height, 2 m distance, referred to free field, with working fans and compressor.

ATTENTION: the refrigerating outputs are meant after deduction of the heat taken from the fans, which must thus be added to the room load. The EER refers only to the room unit. The unit air flow refers in standard configuration with clean class filter G3.

Technical data and performances—water condensation —xxCW series, upward flow—50Hz

MODEL		4SCW	4LCW	6SCW	8SCW
power supply voltage	V/ph/Hz	400/3/50	400/3/50	400/3/50	400/3/50
PERFORMANCES (1)					
air flow	m ³ /s	0.36	0.53	0.61	0.97
available head	Pa	50	50	50	50
fan absorbed power	kW	0.3	0.6	0.4	0.8
fan absorbed current	A	1.4	2.4	2.2	4.2
sound pressure level (2)	dB(A)	47.0	52.3	53.0	53.8
condenser inlet water temperature: 15°C; condensation temperature: 40°C					
total cooling capacity	kW	5.3	8.0	10.5	13.2
sensible cooling capacity	kW	4.5	6.7	8.7	12.2
full absorbed power (fan and compressor)	kW	1.6	2.4	2.6	3.4
compressor absorbed power	kW	1.3	1.8	2.2	2.6
compressor absorbed current	A	5.9	3.5	4.2	5.6
SHR (Sensible Heat Ratio)	—	0.85	0.84	0.83	0.92
EER (Energy Efficiency Ratio)	—	3.42	3.30	3.97	3.87
water flow	l/s	0.05	0.08	0.09	0.12
water pressure drop	kPa	1	2	1	1
condenser inlet water temperature: 30°C; condensation temperature: 45°C					
total cooling capacity	kW	5.1	7.8	9.9	12.8
sensible cooling capacity	kW	4.5	6.5	8.6	12.1
full absorbed power (fan and compressor)	kW	1.7	2.7	2.9	3.7
compressor absorbed power	kW	1.4	2.1	2.5	2.9
compressor absorbed current	A	6.5	3.8	4.5	5.9
SHR (Sensible Heat Ratio)	—	0.87	0.84	0.87	0.94
EER (Energy Efficiency Ratio)	—	3.04	2.93	3.44	3.44
water flow	l/s	0.10	0.18	0.19	0.28
water pressure drop	kPa	2	8	3	7
FANS					
quantity	no.	1	1	1	1
type	—	dd 9/9	dd 9/9	dd 10/10	dd 12/12
speed	no.	3	3	3	3
nominal power	kW	0.245	0.420	0.500	0.736
poles	no.	6	4	6	6
COMPRESSOR					
quantity/type		1/scroll			
nominal power for each compressor	HP	1.90	2.50	3.25	4.00
refrigerant		R22	R22	R22	R22
EVAPORATING COIL					
pipes/fins		copper/aluminium		copper/treated aluminium	
fins for inch/rows	no.	12/3	12/3	12/4	12/4
front surface	m ²	0.33	0.33	0.50	0.50
position/quantity		inclined/1			
CONDENSER					
quantity/type	—	1/plate			
water connections	inch	1/2" BSP			
DIMENSIONS					
length	mm	750	750	750	750
depth	mm	450	450	600	600
height	mm	1950	1950	1950	1950
plan surface	m ²	0.34	0.34	0.45	0.45
WEIGHTS					
net	kg				
gross	kg				

1 ON THE FOLLOWING STANDARD CONDITIONS: standard supply [voltage $\pm 10\%$]; room conditions 24°C bs; 50% R.H. (17°C bu)

2 Measured in the front part at 1 m height, 2 m distance, referred to free field, with working fans and compressor.

ATTENTION: the refrigerating outputs are meant after deduction of the heat taken from the fans, which must thus be added to the room load. The EER refers only to the room unit. The unit air flow refers in standard configuration with clean class filter G3.

Technical data and performances—water condensation —xxCW series, upward flow—60Hz

MODEL		4SCW	4LCW	6SCW	8SCW
power supply voltage	V/ph/Hz	208–230/1/60	200–230/3/60	200–230/3/60	380/3/60
PERFORMANCES (1)					
air flow	m ³ /s	0.38	0.53	0.64	0.99
available head	Pa	0	50	50	50
fan absorbed power	kW	0.4	1.0	0.5	1.1
fan absorbed current	A	1.9	3.9	2.5	4.6
sound pressure level (2)	dB(A)	49.4	51.7	54.7	50.9
condenser inlet water temperature: 15°C; condensation temperature: 40°C					
total cooling capacity	kW	6.3	9.2	11.9	15.5
sensible cooling capacity	kW	5.0	7.2	9.6	13.2
full absorbed power (fan and compressor)	kW	1.9	3.1	3.2	4.2
compressor absorbed power	kW	1.5	2.2	2.7	3.2
compressor absorbed current	A	5.9	6.1	7.3	4.1
SHR (Sensible Heat Ratio)	–	0.80	0.79	0.81	0.85
EER (Energy Efficiency Ratio)	–	3.26	2.93	3.72	3.70
water flow	l/s	0.06	0.09	0.11	0.15
water pressure drop	kPa	1	2	1	2
condenser inlet water temperature: 30°C; condensation temperature: 45°C					
total cooling capacity	kW	6.1	8.9	11.5	15.1
sensible cooling capacity	kW	4.9	7.1	9.5	13.1
full absorbed power (fan and compressor)	kW	2.1	3.4	3.5	4.6
compressor absorbed power	kW	1.7	2.5	3.0	3.5
compressor absorbed current	A	6.5	6.6	7.9	4.5
SHR (Sensible Heat Ratio)	–	0.82	0.80	0.82	0.86
EER (Energy Efficiency Ratio)	–	2.90	2.61	3.31	3.31
water flow	l/s	0.13	0.22	0.24	0.35
water pressure drop	kPa	4	12	5	11
FANS					
quantity	no.	1	1	1	1
type	–	dd 9/9	dd 9/9	dd 10/10	dd 12/12
speed	no.	3	3	3	3
nominal power	kW	0.245	0.420	0.500	0.736
poles	no.	6	4	6	6
COMPRESSOR					
quantity/type				1/scroll	
nominal power for each compressor	HP	1.90	2.50	3.25	4.00
refrigerant		R22	R22	R22	R22
EVAPORATING COIL					
pipes/fins		copper/aluminium			copper/treated aluminium
fins for inch/rows	no.	12/3	12/3	12/4	12/5
front surface	m ²	0.33	0.33	0.33	0.50
position/quantity		inclined/1			
CONDENSER					
quantity/type	–	1/plate			
water connections	inch	½" BSP			
DIMENSIONS					
length	mm	750	750	750	750
depth	mm	450	450	600	750
height	mm	1950	1950	1950	1950
plan surface	m ²	0.34	0.34	0.45	0.56
WEIGHTS					
net	kg				
gross	kg				

1 ON THE FOLLOWING STANDARD CONDITIONS: standard supply [voltage ± 10%]; room conditions 24°C bs; 50% R.H. (17°C bu)

2 Measured in the front part at 1 m height, 2 m distance, referred to free field, with working fans and compressor.

ATTENTION: the refrigerating outputs are meant after deduction of the heat taken from the fans, which must thus be added to the room load. The EER refers only to the room unit. The unit air flow refers in standard configuration with clean class filter G3.

Technical data and performances—dualfluid – air condensation – xxU/OD series –50Hz

MODEL		8GUD	8GOD	8LUD	8LOD
power supply voltage	V/ph/Hz	400/3/50	400/3/50	400/3/50	400/3/50
PERFORMANCES					
air flow	m ³ /s	1.22	1.05	1.22	1.05
available head	Pa	20	50	20	50
fan absorbed power	kW	1.1	1.0	1.1	1.0
fan absorbed current	A	5.0	4.5	5.0	4.5
PERFORMANCES WITH MECHANICAL COOLING ⁽¹⁾					
total cooling capacity	kW	15.6	15.1	14.4	13.7
sensible cooling capacity	kW	13.5	12.5	12.9	11.6
total absorbed power (fan and compressor)	kW	4.9	4.8	4.7	4.6
compressor absorbed power	kW	3.8	3.8	3.6	3.6
compressor absorbed current	A	7.6	7.6	7.3	7.3
SHR (Sensible Heat Ratio)	–	0.87	0.83	0.90	0.85
SPL (Sound Pressure Level) at 2m, f.f. ⁽²⁾	dB(A)	52.1	54.8	52.1	54.8
EER (Energy Efficiency Ratio)	–	3.18	3.15	3.06	2.98
PERFORMANCES IN DUALFLUID MODE					
total cooling capacity	kW	17.8	13.2	17.8	13.2
sensible cooling capacity	kW	16.5	11.8	16.5	11.8
inlet/outlet water temperature	°C	7/12	7/12	7/12	7/12
water flow	l/s	0.850	0.630	0.850	0.630
unit pressure drop – water side	kPa	29	17	29	17
SPL (Sound Pressure Level) at 2m, f.f. ⁽³⁾	dB(A)	51.6	54.5	51.6	54.5
FANS					
quantity	n.	1	1	1	1
type	–	dd 12/12	dd 12/12	dd 12/12	dd 12/12
speed	n.	3	3	3	3
nominal power	kW	0.736	0.736	0.736	0.736
poles	kW	6	6	6	6
COMPRESSOR					
quantity/type	n.	1/scroll		1/scroll	
nominal power for each compressor	HP	5.0	5.0	5.0	5.0
refrigerant	–	R407C	R407C	R22	R22
EVAPORATING COIL					
quantity	n.	1	1	1	1
pipes/fins	–	copper/treated aluminium		copper/treated aluminium	
fins per inch/rows	–	12/5	12/5	12/5	12/5
front surface	m ²	0.50	0.50	0.50	0.50
position	–	inclined		inclined	
REFRIGERANT CONNECTIONS					
gas line (pipe to be welden, o.d.)	mm	16	16	16	16
liquid line (pipe to be welden, o.d.)	mm	14	14	16	16
recommended diameter for refrigerant lines to the condenser (o.d.) Gas – Liquid	mm	16–16	16–16	16–16	16–16
DIMENSIONS					
length	mm	750	750	750	750
depth	mm	750	750	750	750
height	mm	1950	1950	1950	1950
plan surface	m ²	0.56	0.56	0.56	0.56
WEIGHTS					
net	kg	305	305	305	305
gross	kg	315	315	315	315

AT THE FOLLOWING STANDARD CONDITIONS:

- 1 standard supply [voltage $\pm 10\%$]; ambient conditions 24°C bs; 50% R.H.(17°C bu); condensation temperature: 45°C
- 2 Measured at 1 m height and 2 m front distance, in free field, with working fans and compressor.
- 3 Measured at 1 m height and 2 m front distance, in free field, with working fans only.

The cooling capacities are meant after deduction of the heat taken from the fans. Therefore the heat must be added to the ambient load. EER refers to the ambient unit only. The air flow of the units refers to the standard configuration with filter of the G3 class. The standard diameters of the pipes only apply for lengths – between the air conditioner and the condensing unit – up to 30 equivalent m.

Technical data and performances—dualfluid – air condensation – xxU/OD series –50Hz

MODEL		9GUD		9GOD		9LUD		9LOD	
		400/3/50	400/3/50	400/3/50	400/3/50	400/3/50	400/3/50		
power supply voltage	V/ph/Hz								
PERFORMANCES									
air flow	m ³ /s	2.44	2.10			2.45	2.10		
available head	Pa	20	50			20	50		
fans absorbed power	kW	2.2	2.0			2.2	2.0		
each fan absorbed current	A	5.0	4.5			5.0	4.5		
PERFORMANCES WITH MECHANICAL COOLING ⁽¹⁾									
total cooling capacity	kW	31.2	30.2			28.8	27.4		
sensible cooling capacity	kW	27.0	25.0			25.8	23.2		
total absorbed power (fans and compressors)	kW	9.8	9.6			9.4	9.2		
compressors absorbed power	kW	7.6	7.6			7.2	7.2		
each compressors absorbed current	A	7.6	7.6			7.3	7.3		
SHR (Sensible Heat Ratio)	–	0.87	0.83			0.90	0.85		
SPL (Sound Pressure Level) at 2m, f.f. ⁽²⁾	dB(A)	55.1	57.8			55.1	57.8		
EER (Energy Efficiency Ratio)	–	3.18	3.15			3.06	2.98		
PERFORMANCES IN DUALFLUID MODE									
total cooling capacity	kW	35.6	26.4			35.6	26.4		
sensible cooling capacity	kW	33.0	23.6			33.0	23.6		
inlet/outlet water temperature	°C	7/12	7/12			7/12	7/12		
water flow	l/s	1.70	1.26			1.70	1.26		
unit pressure drop – water side	kPa	29	17			29	17		
SPL (Sound Pressure Level) at 2m, f.f. ⁽³⁾	dB(A)	54.6	57.5			54.6	57.5		
FANS									
quantity	n.	2	2			2	2		
type	–	dd 12/12	dd 12/12			dd 12/12	dd 12/12		
speed	n.	3	3			3	3		
nominal power	kW	0.736	0.736			0.736	0.736		
poles	kW	6	6			6	6		
COMPRESSOR									
quantity/type	n.	2/scroll				2/scroll			
nominal power for each compressor	HP	5.0	5.0			5.0	5.0		
refrigerant	–	R407C	R407C			R22	R22		
EVAPORATING COIL									
quantity	n.	2	2			2	2		
pipes/fins	–	copper/treated aluminium				copper/treated aluminium			
fins per inch/rows	–	12/5	12/5			12/5	12/5		
front surface single coil	m ²	0.50	0.50			0.50	0.50		
position	–	inclined				inclined			
REFRIGERANT CONNECTIONS									
gas line (pipe to be welden, o.d.)	mm	16	16			16	16		
liquid line (pipe to be welden, o.d.)	mm	14	14			16	16		
recommended diameter for refrigerant lines to the condenser (o.d.) Gas – Liquid	mm	16–16	16–16			16–16	16–16		
DIMENSIONS									
length	mm	1490	1490			1490	1490		
depth	mm	750	750			750	750		
height	mm	1950	1950			1950	1950		
plan surface	m ²	1.12	1.12			1.12	1.12		
WEIGHTS									
net	kg	595	595			595	595		
gross	kg	615	615			615	615		

AT THE FOLLOWING STANDARD CONDITIONS:

- 1 standard supply [voltage \pm 10%]; ambient conditions 24°C bs; 50% R.H.(17°C bu); condensation temperature: 45°C
- 2 Measured at 1 m height and 2 m front distance, in free field, with working fans and compressor.
- 3 Measured at 1 m height and 2 m front distance, in free field, with working fans only.

The cooling capacities are meant after deduction of the heat taken from the fans. Therefore the heat must be added to the ambient load. EER refers to the ambient unit only. The air flow of the units refers to the standard configuration with filter of the G3 class. The standard diameters of the pipes only apply for lengths – between the air conditioner and the condensing unit – up to 30 equivalent m.

Technical data and performances – dualfluid–air condensation – xxU/OD series –60Hz

MODEL		8GUD	8GOD	8LUD	8LOD
power supply voltage	V/ph/Hz	380/3/60	380/3/60	380/3/60	380/3/60
PERFORMANCES					
air flow	m ³ /s	1.33	1.22	1.33	1.22
available head	Pa	20	50	20	50
fan absorbed power	kW	1.5	1.4	1.5	1.4
fan absorbed current	A	6.6	5.8	6.6	5.8
PERFORMANCES WITH MECHANICAL COOLING ⁽¹⁾					
total cooling capacity	kW	18.3	17.8	16.8	16.1
sensible cooling capacity	kW	15.0	14.4	14.4	13.3
total absorbed power (fan and compressor)	kW	6.1	6.0	5.9	5.8
compressor absorbed power	kW	4.6	4.6	4.4	4.4
compressor absorbed current	A	7.6	7.6	7.3	7.2
SHR (Sensible Heat Ratio)	–	0.82	0.81	0.86	0.83
SPL (Sound Pressure Level) at 2m, f.f. ⁽²⁾	dB(A)	52.6	55.4	52.6	55.4
EER (Energy Efficiency Ratio)	–	3.01	2.97	2.85	2.76
PERFORMANCES IN DUALFLUID MODE					
total cooling capacity	kW	19.1	14.7	19.1	14.7
sensible cooling capacity	kW	17.6	13.1	17.6	13.1
inlet/outlet water temperature	°C	7/12	7/12	7/12	7/12
water flow	l/s	0.908	0.701	0.908	0.701
unit pressure drop – water side	kPa	32	21	32	21
SPL (Sound Pressure Level) at 2m, f.f. ⁽³⁾	dB(A)	52.1	55.0	52.1	55.0
FANS					
quantity	no.	1	1	1	1
type	–	dd 12/12	dd 12/12	dd 12/12	dd 12/12
speed	no.	3	3	3	3
nominal power	kW	0.736	0.736	0.736	0.736
poles	kW	6	6	6	6
COMPRESSORS					
quantity/type	no.	1/scroll		1/scroll	
nominal power for each compressor	HP	5.9	5.9	5.0	5.0
refrigerant	–	R407C	R407C	R22	R22
EVAPORATING COIL					
quantity	no.	1	1	1	1
pipes/fins	–	copper/treated aluminium		copper/treated aluminium	
fins per inch/rows	–	12/5	12/5	12/5	12/5
front surface	m ²	0.50	0.50	0.50	0.50
position	–	inclined		inclined	
REFRIGERANT CONNECTIONS					
gas line (pipe to be welden, o.d.)	mm	16	16	16	16
liquid line (pipe to be welden, o.d.)	mm	14	14	16	16
recommended diameter for refrigerant lines to the condenser (o.d.) Gas – Liquid	mm	16–16	16–16	16–16	16–16
DIMENSIONS					
length	mm	750	750	750	750
depth	mm	750	750	750	750
height	mm	1950	1950	1950	1950
plan surface	m ²	0.56	0.56	0.56	0.56
WEIGHTS					
net	kg	305	305	305	305
gross	kg	315	315	315	315

AT THE FOLLOWING STANDARD CONDITIONS:

- 1 standard supply [voltage $\pm 10\%$]; ambient conditions 24°C bs; 50% R.H.(17°C bu); condensation temperature: 45°C
- 2 Measured at 1 m height and 2 m front distance, in free field, with working fans and compressor.
- 3 Measured at 1 m height and 2 m front distance, in free field, with working fans only.

The cooling capacities are meant after deduction of the heat taken from the fans. Therefore the heat must be added to the ambient load. EER refers to the ambient unit only. The air flow of the units refers to the standard configuration with filter of the G3 class. The standard diameters of the pipes only apply for lengths – between the air conditioner and the condensing unit – up to 30 equivalent m.

Technical data and performances – dualfluid–air condensation – xxU/OD series –60Hz

MODEL		9GUD	9GOD	9LUD	9LOD
power supply voltage	V/ph/Hz	380/3/60	380/3/60	380/3/60	380/3/60
PERFORMANCES					
air flow	m ³ /s	2.66	2.44	2.66	2.44
available head	Pa	20	50	20	50
fans absorbed power	kW	3.0	2.8	3.0	2.8
each fan absorbed current	A	6.6	5.8	6.6	5.8
PERFORMANCES WITH MECHANICAL COOLING ⁽¹⁾					
total cooling capacity	kW	36.6	35.6	33.6	32.2
sensible cooling capacity	kW	30.0	28.8	28.8	26.6
total absorbed power (fans and compressors)	kW	12.2	12.0	11.8	11.6
compressors absorbed power	kW	9.2	9.2	8.8	8.8
each compressors absorbed current	A	7.6	7.6	7.3	7.2
SHR (Sensible Heat Ratio)	–	0.82	0.81	0.86	0.83
SPL (Sound Pressure Level) at 2m, f.f. ⁽²⁾	dB(A)	55.6	58.4	55.6	58.4
EER (Energy Efficiency Ratio)	–	3.01	2.97	2.85	2.76
PERFORMANCES IN DUALFLUID MODE					
total cooling capacity	kW	38.2	29.4	38.2	29.4
sensible cooling capacity	kW	35.2	26.2	35.2	26.2
inlet/outlet water temperature	°C	7/12	7/12	7/12	7/12
water flow	l/s	1.816	1.402	1.816	1.402
unit pressure drop – water side	kPa	32	21	32	21
SPL (Sound Pressure Level) at 2m, f.f. ⁽³⁾	dB(A)	55.1	58.0	55.1	58.0
FANS					
quantity	no.	2	2	2	2
type	–	dd 12/12	dd 12/12	dd 12/12	dd 12/12
speed	no.	3	3	3	3
nominal power	kW	0.736	0.736	0.736	0.736
poles	kW	6	6	6	6
COMPRESSORS					
quantity/type	no.	2/scroll		2/scroll	
nominal power for each compressor	HP	5.9	5.9	5.0	5.0
refrigerant	–	R407C	R407C	R22	R22
EVAPORATING COIL					
quantity	no.	2	2	2	2
pipes/fins	–	copper/treated aluminium		copper/treated aluminium	
fins per inch/rows	–	12/5	12/5	12/5	12/5
front surface single coil	m ²	0.50	0.50	0.50	0.50
position	–	inclined		inclined	
REFRIGERANT CONNECTIONS					
gas line (pipe to be welden, o.d.)	mm	16	16	16	16
liquid line (pipe to be welden, o.d.)	mm	14	14	16	16
recommended diameter for refrigerant lines to the condenser (o.d.) Gas – Liquid	mm	16–16	16–16	16–16	16–16
DIMENSIONS					
length	mm	1490	1490	1490	1490
depth	mm	750	750	750	750
height	mm	1950	1950	1950	1950
plan surface	m ²	1.12	1.12	1.12	1.12
WEIGHTS					
net	kg	595	595	595	595
gross	kg	615	615	615	615

AT THE FOLLOWING STANDARD CONDITIONS:

- 1 standard supply [voltage ± 10%]; ambient conditions 24°C bs; 50% R.H.(17°C bu); condensation temperature: 45°C
- 2 Measured at 1 m height and 2 m front distance, in free field, with working fans and compressor.
- 3 Measured at 1 m height and 2 m front distance, in free field, with working fans only.

The cooling capacities are meant after deduction of the heat taken from the fans. Therefore the heat must be added to the ambient load. EER refers to the ambient unit only. The air flow of the units refers to the standard configuration with filter of the G3 class. The standard diameters of the pipes only apply for lengths – between the air conditioner and the condensing unit – up to 30 equivalent m.

Technical data and performances – dualfluid – water condensation – xxU/OH series – 50Hz

MODEL		8GUH	8GOH	8LUH	8LOH
power supply voltage	V/ph/Hz	400/3/50	400/3/50	400/3/50	400/3/50
PERFORMANCES (1)					
air flow	m³/s	1.22	1.05	1.22	1.05
available head	Pa	20	50	20	50
fan absorbed power	kW	1.1	1.0	1.1	1.0
fan absorbed current	A	5.0	4.5	5.0	4.5
SPL (Sound Pressure Level) at 2m, f.f. (2)	dB(A)	52.1	54.8	52.1	54.8
water temperature at the condenser inlet: 15°C – condensation temperature: 40°C					
total cooling capacity	kW	16.3	15.8	15.0	14.1
sensible cooling capacity	kW	13.7	12.8	13.1	11.8
full absorbed power (fan and compressor)	kW	4.6	4.4	4.4	4.3
compressor absorbed power	kW	3.4	3.4	3.2	3.2
compressor absorbed current	A	7.2	7.2	6.9	6.9
SHR (sensible/full ratio)	–	0.84	0.81	0.88	0.83
EER (Energy Efficiency Ratio)	–	3.57	3.57	3.41	3.32
water flow	l/s	0.16	0.16	0.15	0.14
water pressure drop	kPa	3	2	2	2
water temperature at the condenser inlet: 30°C – condensation temperature: 45°C					
total cooling capacity	kW	15.6	15.1	14.4	13.7
sensible cooling capacity	kW	13.5	12.5	12.9	11.6
full absorbed power (fan and compressor)	kW	5.0	4.8	4.8	4.6
compressor absorbed power	kW	3.8	3.8	3.6	3.6
compressor absorbed current	A	7.6	7.6	7.3	7.3
SHR (sensible/full ratio)	–	0.86	0.83	0.89	0.84
EER (output/used energy)	–	3.15	3.15	3.02	2.95
water flow	l/s	0.38	0.36	0.34	0.32
water pressure drop	kPa	13	12	10.1	9
PERFORMANCES IN DUALFLUID MODE					
full refrigerating power	kW	17.8	13.2	17.8	13.2
sensible refrigerating power	kW	16.5	11.8	16.5	11.8
sound pressure level (3)	dB(A)	51.6	54.5	51.6	54.5
water inlet/outlet	°C	7/12	7/12	7/12	7/12
water flow	l/s	0.85	0.63	0.85	0.63
water pressure drop	kPa	29	17	29	17
FANS					
quantity	no.	1	1	1	1
type	–	dd 12/12	dd 12/12	dd 12/12	dd 12/12
speed	no.	3	3	3	3
nominal power	kW	0.736	0.736	0.736	0.736
poles	no.	6	6	6	6
COMPRESSOR					
quantity/type	no.	1/scroll		1/scroll	
nominal power for each compressor	HP	5.0	5.0	5.0	5.0
refrigerant	–	R407C	R407C	R22	R22
EVAPORATING COIL CHILLED WATER					
pipes/fins	–	copper/treated aluminium		copper/treated aluminium	
fins per inch/rows	–	12/5	12/5	12/5	12/5
front surface	m²	0.50	0.50	0.50	0.50
structure/quantity	–	inclined/1		inclined/1	
CONDENSER					
quantity/type	–	1/plate		1/plate	
water connections	inch	½" BSP	½" BSP	½" BSP	½" BSP
DIMENSIONS					
length	mm	750	750	750	750
depth	mm	750	750	750	750
height	mm	1950	1950	1950	1950
plan surface	m²	0.56	0.56	0.56	0.56
WEIGHTS					
net	kg	310	310	310	310
gross	kg	320	320	320	320

AT THE FOLLOWING STANDARD CONDITIONS:

- 1 standard supply [voltage ± 10%]; ambient conditions 24°C bs; 50% R.H.(17°C bu)
- 2 Measured at 1 m height and 2 m front distance, in free field, with working fans and compressor.
- 3 Measured at 1 m height and 2 m front distance, in free field, with working fans only.

The cooling capacities are meant after deduction of the heat taken from the fans. Therefore the heat must be added to the ambient load. EER refers to the ambient unit only. The air flow of the units refers to the standard configuration with filter of the G3 class. The standard diameters of the pipes only apply for lengths – between the air conditioner and the condensing unit – up to 30 equivalent m.

Technical data and performances – dualfluid – water condensation – xxU/OH series – 50Hz

MODEL		9GUH	9GOH	9LUH	9LOH
power supply voltage	V/ph/Hz	400/3/50	400/3/50	400/3/50	400/3/50
PERFORMANCES (1)					
air flow	m³/s	2.44	2.10	2.45	2.10
available head	Pa	20	50	20	50
fans absorbed power	kW	2.2	2.0	2.2	2.0
each fan absorbed current	A	5.0	4.5	5.0	4.5
SPL (Sound Pressure Level) at 2m, f.f. (2)	dB(A)	55.1	57.8	55.1	57.8
water temperature at the condenser inlet: 15°C – condensation temperature: 40°C					
total cooling capacity	kW	32.6	31.6	30.0	28.2
sensible cooling capacity	kW	27.4	25.6	26.2	23.6
full absorbed power (fans and compressors)	kW	9.2	8.8	8.8	8.6
compressors absorbed power	kW	6.8	6.8	6.4	6.4
each compressors absorbed current	A	7.2	7.2	6.9	6.9
SHR (sensible/full ratio)	–	0.84	0.81	0.88	0.83
EER (Energy Efficiency Ratio)	–	3.57	3.57	3.41	3.32
water flow	l/s	0.32	0.32	0.30	0.28
water pressure drop	kPa	3	2	2	2
water temperature at the condenser inlet: 30°C – condensation temperature: 45°C					
total cooling capacity	kW	31.2	30.2	28.8	27.4
sensible cooling capacity	kW	27.0	25.0	25.8	23.2
full absorbed power (fans and compressors)	kW	10.0	9.6	9.6	9.2
compressors absorbed power	kW	7.6	7.6	7.2	7.2
each compressors absorbed current	A	7.6	7.6	7.3	7.3
SHR (sensible/full ratio)	–	0.86	0.83	0.89	0.84
EER (output/used energy)	–	3.15	3.15	3.02	2.95
water flow	l/s	0.76	0.72	0.68	0.64
water pressure drop	kPa	13	12	10.1	9
PERFORMANCES IN DUALFLUID MODE					
full refrigerating power	kW	35.6	26.4	35.6	26.4
sensible refrigerating power	kW	33.0	23.6	33.0	23.6
sound pressure level (3)	dB(A)	54.6	57.6	54.6	57.5
water inlet/outlet	°C	7/12	7/12	7/12	7/12
water flow	l/s	1.70	1.26	1.70	1.26
water pressure drop	kPa	29	17	29	27
FANS					
quantity	no.	2	2	2	2
type	–	dd 12/12	dd 12/12	dd 12/12	dd 12/12
speed	no.	3	3	3	3
nominal power	kW	0.736	0.736	0.736	0.736
poles	no.	6	6	6	6
COMPRESSORS					
quantity/type	no.	2/scroll		2/scroll	
nominal power for each compressor	HP	5.0	5.0	5.0	5.0
refrigerant	–	R407C	R407C	R22	R22
EVAPORATING COIL CHILLED WATER					
pipes/fins	–	copper/treated aluminium		copper/treated aluminium	
fins per inch/rows	–	12/5	12/5	12/5	12/5
front surface single coil	m²	0.50	0.50	0.50	0.50
structure/quantity	–	inclined/2		inclined/2	
CONDENSERS					
quantity/type	–	2/plate		2/plate	
water connections	inch	½" BSP	½" BSP	½" BSP	½" BSP
DIMENSIONS					
length	mm	1490	1490	1490	1490
depth	mm	750	750	750	750
height	mm	1950	1950	1950	1950
plan surface	m²	1.12	1.12	1.12	1.12
WEIGHTS					
net	kg	605	605	605	605
gross	kg	625	625	625	625

AT THE FOLLOWING STANDARD CONDITIONS:

- 1 standard supply [voltage ± 10%]; ambient conditions 24°C bs; 50% R.H.(17°C bu)
- 2 Measured at 1 m height and 2 m front distance, in free field, with working fans and compressor.
- 3 Measured at 1 m height and 2 m front distance, in free field, with working fans only.

The cooling capacities are meant after deduction of the heat taken from the fans. Therefore the heat must be added to the ambient load. EER refers to the ambient unit only. The air flow of the units refers to the standard configuration with filter of the G3 class. The standard diameters of the pipes only apply for lengths – between the air conditioner and the condensing unit – up to 30 equivalent m.

Technical data and performances – dualfluid –water condensation – xxU/OH series –60Hz

MODEL		8GUH	8GOH	8LUH	8LOH
		380/3/60	380/3/60	380/3/60	380/3/60
power supply voltage	V/ph/Hz				
PERFORMANCES (1)					
air flow	m ³ /s	1.33	1.22	1.33	1.22
available head	Pa	20	50	20	50
fan absorbed power	kW	1.5	1.4	1.5	1.4
each fan absorbed current	A	6.6	5.8	6.6	5.8
SPL (Sound Pressure Level) at 2m, f.f. (2)	dB(A)	52.6	55.4	52.6	55.4
water temperature at the condenser inlet: 15 °C – condensation temperature: 40 °C					
total cooling capacity	kW	19.1	18.6	17.3	16.6
sensible cooling capacity	kW	15.4	14.7	14.7	13.5
full absorbed power (fan and compressor)	kW	5.6	5.5	5.4	5.3
compressor absorbed power	kW	4.1	4.1	3.9	3.9
each compressors absorbed current	A	7.2	7.2	6.9	6.9
SHR (sensible/full ratio)	–	0.81	0.79	0.85	0.81
EER (Energy Efficiency Ratio)	–	3.41	3.39	3.22	3.14
water flow	l/s	0.20	0.19	0.18	0.17
water pressure drop	kPa	4	4	3	3
water temperature at the condenser inlet: 30 °C – condensation temperature: 45 °C					
total cooling capacity	kW	18.3	17.8	16.8	16.1
sensible cooling capacity	kW	15.0	14.4	14.4	13.3
full absorbed power (fan and compressor)	kW	6.1	6.0	5.9	5.8
compressor absorbed power	kW	4.6	4.6	4.4	4.4
each compressors absorbed current	A	7.6	7.6	7.3	7.2
SHR (sensible/full ratio)	–	0.82	0.81	0.86	0.83
EER (output/used energy)	–	3.00	2.98	2.85	2.78
water flow	l/s	0.48	0.47	0.43	0.41
water pressure drop	kPa	20	19	16	15
PERFORMANCES IN DUALFLUID MODE					
full refrigerating power	kW	19.1	14.7	19.1	14.7
sensible refrigerating power	kW	17.6	13.1	17.6	13.1
sound pressure level (3)	dB(A)	52.1	55.0	52.1	55.0
water inlet/outlet	°C	7/12	7/12	7/12	7/12
water flow	l/s	0.91	0.70	0.91	0.70
water pressure drop	kPa	32	21	32	21
FANS					
quantity	no.	1	1	1	1
type	–	dd 12/12	dd 12/12	dd 12/12	dd 12/12
speed	no.	3	3	3	3
nominal power	kW	0.736	0.736	0.736	0.736
poles	no.	6	6	6	6
COMPRESSOR					
quantity/type	no.	1/scroll		1/scroll	
nominal power for each compressor	HP	5.0	5.9	5.0	5.0
refrigerant	–	R407C	R407C	R22	R22
EVAPORATING COIL CHILLED WATER					
pipes/fins	–	copper/treated aluminium		copper/treated aluminium	
fins per inch/rows	–	12/5	12/5	12/5	12/5
front surface	m ²	0.50	0.50	0.50	0.50
structure/quantity	–	inclined/1		inclined/1	
CONDENSER					
quantity/type	–	1/plate		1/plate	
water connections	inch	½" BSP	½" BSP	½" BSP	½" BSP
DIMENSIONS					
length	mm	750	750	750	750
depth	mm	750	750	750	750
height	mm	1950	1950	1950	1950
plan surface	m ²	0.56	0.56	0.56	0.56
WEIGHTS					
net	kg	310	310	310	310
gross	kg	320	320	320	320

AT THE FOLLOWING STANDARD CONDITIONS:

- 1 standard supply [voltage ± 10%]; ambient conditions 24 °C bs; 50% R.H.(17 °C bu)
- 2 Measured at 1 m height and 2 m front distance, in free field, with working fans and compressor.
- 3 Measured at 1 m height and 2 m front distance, in free field, with working fans only.

The cooling capacities are meant after deduction of the heat taken from the fans. Therefore the heat must be added to the ambient load. EER refers to the ambient unit only. The air flow of the units refers to the standard configuration with filter of the G3 class. The standard diameters of the pipes only apply for lengths – between the air conditioner and the condensing unit – up to 30 equivalent m.

Technical data and performances – dualfluid –water condensation – xxU/OH series –60Hz

MODEL		9GUH	9GOH	9LUH	9LOH
power supply voltage	V/ph/Hz	380/3/60	380/3/60	380/3/60	380/3/60
PERFORMANCES (1)					
air flow	m ³ /s	2.66	2.44	2.66	2.44
available head	Pa	20	50	20	50
fans absorbed power	kW	3.0	2.8	3.0	2.8
fans absorbed current	A	6.6	5.8	6.6	5.8
SPL (Sound Pressure Level) at 2m, f.f. (2)	dB(A)	55.6	58.4	55.6	58.4
water temperature at the condenser inlet: 15°C – condensation temperature: 40°C					
total cooling capacity	kW	38.2	37.2	34.6	33.2
sensible cooling capacity	kW	30.8	29.4	29.4	27.0
full absorbed power (fans and compressors)	kW	11.2	11.0	10.8	10.6
compressors absorbed power	kW	8.2	8.2	7.8	7.8
compressors absorbed current	A	7.2	7.2	6.9	6.9
SHR (sensible/full ratio)	–	0.81	0.79	0.85	0.81
EER (Energy Efficiency Ratio)	–	3.41	3.39	3.22	3.14
water flow	l/s	0.40	0.38	0.36	0.34
water pressure drop	kPa	4	4	3	3
water temperature at the condenser inlet: 30°C – condensation temperature: 45°C					
total cooling capacity	kW	36.6	35.6	33.6	32.2
sensible cooling capacity	kW	30.0	28.8	28.8	26.6
full absorbed power (fans and compressors)	kW	12.2	12.0	11.8	11.6
compressors absorbed power	kW	9.2	9.2	8.8	8.8
compressors absorbed current	A	7.6	7.6	7.3	7.2
SHR (sensible/full ratio)	–	0.82	0.81	0.86	0.83
EER (output/used energy)	–	3.00	2.98	2.85	2.78
water flow	l/s	0.96	0.94	0.86	0.82
water pressure drop	kPa	20	19	16	15
PERFORMANCES IN DUALFLUID MODE					
full refrigerating power	kW	38.2	29.4	38.2	29.4
sensible refrigerating power	kW	35.2	26.2	35.2	26.2
sound pressure level (3)	dB(A)	55.1	58.0	55.1	58.0
water inlet/outlet	°C	7/12	7/12	7/12	7/12
water flow	l/s	1.82	1.40	1.82	1.40
water pressure drop	kPa	32	21	32	21
FANS					
quantity	no.	2	2	2	2
type	–	dd 12/12	dd 12/12	dd 12/12	dd 12/12
speed	no.	3	3	3	3
nominal power	kW	0.736	0.736	0.736	0.736
poles	no.	6	6	6	6
COMPRESSORS					
quantity/type	no.	2/scroll		2/scroll	
nominal power for each compressor	HP	5.0	5.9	5.0	5.0
refrigerant	–	R407C	R407C	R22	R22
EVAPORATING COIL CHILLED WATER					
pipes/fins	–	copper/treated aluminium		copper/treated aluminium	
fins per inch/rows	–	12/5	12/5	12/5	12/5
front surface single coil	m ²	0.50	0.50	0.50	0.50
structure/quantity	–	inclined/2		inclined/2	
CONDENSERS					
quantity/type	–	2/plate		2/plate	
water connections	inch	½" BSP	½" BSP	½" BSP	½" BSP
DIMENSIONS					
length	mm	1490	1490	1490	1490
depth	mm	750	750	750	750
height	mm	1950	1950	1950	1950
plan surface	m ²	1.12	1.12	1.12	1.12
WEIGHTS					
net	kg	605	605	605	605
gross	kg	625	625	625	625

AT THE FOLLOWING STANDARD CONDITIONS:

- 1 standard supply [voltage ± 10%]; ambient conditions 24°C bs; 50% R.H.(17°C bu)
- 2 Measured at 1 m height and 2 m front distance, in free field, with working fans and compressor.
- 3 Measured at 1 m height and 2 m front distance, in free field, with working fans only.

The cooling capacities are meant after deduction of the heat taken from the fans. Therefore the heat must be added to the ambient load. EER refers to the ambient unit only. The air flow of the units refers to the standard configuration with filter of the G3 class. The standard diameters of the pipes only apply for lengths – between the air conditioner and the condensing unit – up to 30 equivalent m.

Technical data and performances – freecooler – xxU/OF series – 50Hz

MODEL		8GUF	8GOF	8LUF	8LOF
power supply voltage	V/ph/Hz	400/3/50	400/3/50	400/3/50	400/3/50
PERFORMANCES					
air flow	m ³ /s	1.22	1.05	1.22	1.05
available head	Pa	20	50	20	50
fan absorbed power	kW	1.1	1.0	1.1	1.0
fan absorbed current	A	5.0	4.5	5.0	4.5
glycol percentage	%	30.0	30.0	30.0	30.0
PERFORMANCES WITH MECHANICAL COOLING (1)					
total cooling capacity	kW	14.0	14.0	13.6	13.3
sensible cooling capacity	kW	13.0	12.1	12.5	11.7
full absorbed power (fan and compressor)	kW	5.8	5.7	5.5	5.4
compressor absorbed power	kW	4.7	4.6	4.4	4.4
compressor absorbed current	A	8.5	8.5	8.1	8.1
SHR (Sensible Heat Ratio)	–	0.93	0.87	0.92	0.88
EER (Sensible Heat Ratio)	–	2.40	2.45	2.44	2.44
mixture inlet temperature	°C	42.0	41.9	41.7	41.6
mixture flowrate	l/s	0.64	0.64	0.64	0.64
mixture pressure drop condenser	kPa	38	38	38	38
mixture pressure drop pressostatic valve	kPa	52	52	52	52
SPL (Sound Pressure Level) (2)	dB(A)	52.1	54.8	52.1	54.8
PERFORMANCES IN FREECOOLING MODE					
total cooling capacity	kW	11.8	11.1	11.8	11.1
sensible cooling capacity	kW	11.8	11.1	11.8	11.1
mixture inlet temperature	°C	7.0	7.0	7.0	7.0
mixture flowrate	l/s	0.64	0.64	0.64	0.64
mixture pressure drop condenser	kPa	20	20	20	20
SPL (Sound Pressure Level) (3)	dB(A)	51.7	54.5	51.6	54.5
PERFORMANCES AT ZET MODE (4)					
mixture inlet temperature Eintrittstemperatur MIX.	°C	5.3	5.4	6.4	6.5
ZET (Zero Energy Temperature)	°C	0.1	0.5	1.4	1.8
mixture flowrate	l/s	0.64	0.64	0.64	0.64
mixture pressure drop unit	kPa	20	20	20	20
mixture pressure drop rad-cooler	kPa	7	7	7	7
rad cooler ARN	mod.	DSM013	DSM013	DSM013	DSM013
FANS					
quantity	no.	1	1	1	1
type	–	dd 12/12	dd 12/12	dd 12/12	dd 12/12
speed	n.	3	3	3	3
nominal power	kW	0.736	0.736	0.736	0.736
poles	no.	6	6	6	6
COMPRESSOR					
quantity	no.	1	1	1	1
type	–	scroll		scroll	
nominal power for each compressor	HP	5.0	5.0	5.0	5.0
refrigerant	–	R407C	R407C	R22	R22
EVAPORATING COIL					
quantity	no.	1	1	1	1
pipes/fins	–	copper/treated aluminium		copper/treated aluminium	
fins per inch/rows	–	12/5	12/5	12/5	12/5
front surface	m ²	0.50	0.50	0.50	0.50
position	–	inclined		inclined	
CONDENSER					
type	–	plate		plate	
quantity	–	1	1	1	1
water connections	inch	½ BSP	½ BSP	½ BSP	½ BSP
DIMENSIONS					
length	mm	750	750	750	750
depth	mm	750	750	750	750
height	mm	1950	1950	1950	1950
plan surface	m ²	0.56	0.56	0.56	0.56
WEIGHTS					
net	kg	310	310	310	310
gross	kg	320	320	320	320

AT THE FOLLOWING STANDARD CONDITIONS:

- 1 standard supply [voltage $\pm 10\%$]; ambient conditions 24°C bs; 50% R.H.(17°C bu); external temperature = 35°C
- 2 Measured at 1 m height and 2 m front distance, in free field, with working fans and compressor.
- 3 Measured at 1 m height and 2 m front distance, in free field, with working fans only.
- 4 ZET: Is the outdoor air temperature value ...

The cooling capacities are meant after deduction of the heat taken from the fans. Therefore the heat must be added to the ambient load. EER refers to the ambient unit only. The air flow of the units refers to the standard configuration with filter of the G3 class. The standard diameters of the pipes only apply for lengths – between the air conditioner and the condensing unit – up to 30 equivalent m.

Technical data and performances – freecooler – xxU/OF series – 50Hz

MODEL		9GUF	9GOF	9LUF	9LOF
power supply voltage	V/ph/Hz	400/3/50	400/3/50	400/3/50	400/3/50
PERFORMANCES					
air flow	m ³ /s	2.45	2.10	2.45	2.10
available head	Pa	20	50	20	50
fans absorbed power	kW	2.3	2.0	2.3	2.0
each fan absorbed current	A	5.0	4.5	5.0	4.5
glycol percentage	%	30.0	30.0	30.0	30.0
PERFORMANCES WITH MECHANICAL COOLING (1)					
total cooling capacity	kW	28.2	27.9	27.2	26.7
sensible cooling capacity	kW	26.0	24.3	24.7	23.3
full absorbed power (fans and compressors)	kW	11.7	11.4	11.2	10.8
compressors absorbed power	kW	9.4	9.3	8.9	8.8
each compressors absorbed current	A	8.5	8.5	8.1	8.1
SHR (Sensible Heat Ratio)	–	0.92	0.87	0.91	0.87
EER (Sensible Heat Ratio)	–	2.42	2.45	2.43	2.46
mixture inlet temperature	°C	41.9	41.8	41.6	41.5
mixture flowrate	l/s	1.28	1.28	1.28	1.28
mixture pressure drop condensers	kPa	38	38	38	38
mixture pressure drop pressostatic valve	kPa	52	52	52	52
SPL (Sound Pressure Level) (2)	dB(A)	55.1	57.8	55.1	57.8
PERFORMANCES IN FREECOOLING MODE					
total cooling capacity	kW	23.5	22.0	23.5	22.0
sensible cooling capacity	kW	23.5	22.0	23.5	22.0
mixture inlet temperature	°C	7.0	7.0	7.0	7.0
mixture flowrate	l/s	1.28	1.28	1.28	1.28
mixture pressure drop condensers	kPa	29	28	29	28
SPL (Sound Pressure Level) (3)	dB(A)	54.7	57.5	54.6	57.5
PERFORMANCES AT ZET MODE (4)					
mixture inlet temperature Eintrittstemperatur MIX.	°C	5.0	5.2	6.2	6.5
ZET (Zero Energy Temperature)	°C	0.4	0.2	1.1	1.7
mixture flowrate	l/s	1.28	1.28	1.28	1.28
mixture pressure drop unit	kPa	29	28	29	28
mixture pressure drop rad-cooler	kPa	15	15	15	15
rad cooler ARN	mod.	DSM028	DSM028	DSM028	DSM028
FANS					
quantity	no.	2	2	2	2
type	–	dd 12/12	dd 12/12	dd 12/12	dd 12/12
speed	n.	3	3	3	3
nominal power	kW	0.736	0.736	0.736	0.736
poles	no.	6	6	6	6
COMPRESSORS					
quantity	no.	2	2	2	2
type	–	scroll	scroll	scroll	scroll
nominal power for each compressor	HP	5.0	5.0	5.0	5.0
refrigerant	–	R407C	R407C	R22	R22
EVAPORATING COIL					
quantity	no.	2	2	2	2
pipes/fins	–	copper/treated aluminium	copper/treated aluminium	copper/treated aluminium	copper/treated aluminium
fins per inch/rows	–	12/5	12/5	12/5	12/5
front surface single coil	m ²	0.50	0.50	0.50	0.50
position	–	inclined	inclined	inclined	inclined
CONDENSERS					
type	–	plate	plate	plate	plate
quantity	–	2	2	2	2
water connections	inch	½ BSP	½ BSP	½ BSP	½ BSP
DIMENSIONS					
length	mm	1490	1490	1490	1490
depth	mm	750	750	750	750
height	mm	1950	1950	1950	1950
plan surface	m ²	1.12	1.12	1.12	1.12
WEIGHTS					
net	kg	615	615	615	615
gross	kg	635	635	635	635

AT THE FOLLOWING STANDARD CONDITIONS:

- 1 standard supply [voltage ± 10%]; ambient conditions 24°C bs; 50% R.H.(17°C bu); external temperature = 35°C
- 2 Measured at 1 m height and 2 m front distance, in free field, with working fans and compressor.
- 3 Measured at 1 m height and 2 m front distance, in free field, with working fans only.
- 4 ZET: Is the outdoor air temperature value ...

The cooling capacities are meant after deduction of the heat taken from the fans. Therefore the heat must be added to the ambient load. EER refers to the ambient unit only. The air flow of the units refers to the standard configuration with filter of the G3 class. The standard diameters of the pipes only apply for lengths – between the air conditioner and the condensing unit – up to 30 equivalent m.

Technical data and performances – freecooler –xxU/OH series –60Hz

MODEL		8GUF	8GOF	8LUF	8LOF
power supply voltage	V/ph/Hz	380/3/60	380/3/60	380/3/60	380/3/60
PERFORMANCES					
air flow	m ³ /s	1.33	1.22	1.33	1.22
available head	Pa	20	50	20	50
fan absorbed power	kW	1.5	1.4	1.5	1.4
each fan absorbed current	A	6.6	5.8	6.6	5.8
glycol percentage	%	30.0	30.0	30.0	30.0
PERFORMANCES WITH MECHANICAL COOLING (1)					
total cooling capacity	kW	19.1	19.0	17.6	17.1
sensible cooling capacity	kW	15.5	15.0	14.6	14.1
full absorbed power (fan and compressor)	kW	6.0	5.9	5.9	5.8
compressor absorbed power	kW	4.5	4.5	4.4	4.4
each compressors absorbed current	A	7.5	7.5	8.7	8.7
SHR (Sensible Heat Ratio)	–	0.89	0.83	0.83	0.82
EER (Sensible Heat Ratio)	–	3.16	3.20	2.99	2.98
mixture inlet temperature	°C	3.0	30	30	30
mixture flowrate	l/s	0.615	0.607	0.542	0.534
mixture pressure drop condenser	kPa	36	35	28	27
mixture pressure drop pressostatic valve	kPa	48	47	38	36
SPL (Sound Pressure Level) (2)	dB(A)	52.6	55.4	52.6	55.4
PERFORMANCES IN FREECOOLING MODE					
total cooling capacity	kW	12.0	11.6	11.2	10.8
sensible cooling capacity	kW	12.0	11.6	11.2	10.8
mixture inlet temperature	°C	7.0	7.0	7.0	7.0
mixture flowrate	l/s	0.625	0.607	0.545	0.534
mixture pressure drop condenser	kPa	19	18	15	15
SPL (Sound Pressure Level) (3)	dB(A)	52.1	55.0	52.1	55.0
FANS					
quantity	n.	1	1	1	1
type	–	dd 12/12	dd 12/12	dd 12/12	dd 12/12
speed	n.	3	3	3	3
nominal power	kW	0.736	0.736	0.736	0.736
poles	n.	6	6	6	6
COMPRESSOR					
quantity	n.	1	1	1	1
type	–	scroll		scroll	
nominal power for each compressor	HP	5.0	5.9	5.0	5.0
refrigerant	–	R407C	R407C	R22	R22
EVAPORATING COIL					
quantity	n.	1	1	1	1
pipes/fins	–	copper/treated aluminium		copper/treated aluminium	
fins per inch/rows	–	12/5	12/5	12/5	12/5
front surface	m ²	0.50	0.50	0.50	0.50
position	–	inclined		inclined	
CONDENSER					
type	–	plate		plate	
quantity	–	1	1	1	1
water connections	inch	½ BSP	½ BSP	½ BSP	½ BSP
DIMENSIONS					
length	mm	750	750	750	750
depth	mm	750	750	750	750
height	mm	1950	1950	1950	1950
plan surface	m ²	0.56	0.56	0.56	0.56
WEIGHTS					
net	kg	310	310	310	310
gross	kg	320	320	320	320

AT THE FOLLOWING STANDARD CONDITIONS:

- 1 standard supply [voltage $\pm 10\%$]; ambient conditions 24°C bs; 50% R.H.(17°C bu); external temperature = 35°C
- 2 Measured at 1 m height and 2 m front distance, in free field, with working fans and compressor.
- 3 Measured at 1 m height and 2 m front distance, in free field, with working fans only.

The cooling capacities are meant after deduction of the heat taken from the fans. Therefore the heat must be added to the ambient load. EER refers to the ambient unit only. The air flow of the units refers to the standard configuration with filter of the G3 class. The standard diameters of the pipes only apply for lengths – between the air conditioner and the condensing unit – up to 30 equivalent m.

Technical data and performances – freecooler –xxU/OH series –60Hz

MODEL		9GUF	9GOF	9LUF	9LOF
power supply voltage	V/ph/Hz	380/3/60	380/3/60	380/3/60	380/3/60
PERFORMANCES					
air flow	m ³ /s	2.66	2.44	2.66	2.44
available head	Pa	20	50	20	50
fans absorbed power	kW	3.0	2.8	3.0	2.8
fans absorbed current	A	6.6	5.8	6.6	5.8
glycol percentage	%	30.0	30.0	30.0	30.0
PERFORMANCES WITH MECHANICAL COOLING (1)					
total cooling capacity	kW	37.9	37.5	35.5	34.4
sensible cooling capacity	kW	30.7	29.7	29.1	27.9
full absorbed power (fans and compressors)	kW	12.1	11.8	11.8	11.5
compressors absorbed power	kW	9.1	9.1	8.8	8.7
each compressors absorbed current	A	7.5	7.5	8.8	8.8
SHR (Sensible Heat Ratio)	–	0.83	0.84	0.81	0.82
EER (Sensible Heat Ratio)	–	3.13	3.19	3.01	3.00
mixture inlet temperature	°C	30	30	30	30
mixture flowrate	l/s	1.233	1.211	1.100	1.1074
mixture pressure drop condensers	kPa	36	35	29	27
mixture pressure drop pressostatic valve	kPa	49	47	39	37
SPL (Sound Pressure Level) (2)	dB(A)	55.6	58.4	55.6	58.4
PERFORMANCES IN FREECOOLING MODE					
total cooling capacity	kW	23.8	22.8	22.3	21.2
sensible cooling capacity	kW	23.8	22.8	22.3	21.2
mixture inlet temperature	°C	7.0	7.0	7.0	7.0
mixture flowrate	l/s	1.233	1.211	1.100	1.074
mixture pressure drop condensers	kPa	27	26	22	22
SPL (Sound Pressure Level) (3)	dB(A)	55.1	58.0	55.1	58.0
FANS					
quantity	n.	2	2	2	2
type	–	dd 12/12	dd 12/12	dd 12/12	dd 12/12
speed	n.	3	3	3	3
nominal power	kW	0.736	0.736	0.736	0.736
poles	n.	6	6	6	6
COMPRESSORS					
quantity	n.	2	2	2	2
type	–	scroll		scroll	
nominal power for each compressor	HP	5.0	5.9	5.0	5.0
refrigerant	–	R407C	R407C	R22	R22
EVAPORATING COIL					
quantity	n.	2	2	2	2
pipes/fins	–	copper/treated aluminium		copper/treated aluminium	
fins per inch/rows	–	12/5	12/5	12/5	12/5
front surface single coil	m ²	0.50	0.50	0.50	0.50
position	–	inclined		inclined	
CONDENSERS					
type	–	plate		plate	
quantity	–	2	2	2	2
water connections	inch	½ BSP	½ BSP	½ BSP	½ BSP
DIMENSIONS					
length	mm	1490	1490	1490	1490
depth	mm	750	750	750	750
height	mm	1950	1950	1950	1950
plan surface	m ²	1.12	1.12	1.12	1.12
WEIGHTS					
net	kg	615	615	615	615
gross	kg	635	635	635	635

AT THE FOLLOWING STANDARD CONDITIONS:

- 1 standard supply [voltage ± 10%]; ambient conditions 24°C bs; 50% R.H.(17°C bu); external temperature = 35°C
- 2 Measured at 1 m height and 2 m front distance, in free field, with working fans and compressor.
- 3 Measured at 1 m height and 2 m front distance, in free field, with working fans only.

The cooling capacities are meant after deduction of the heat taken from the fans. Therefore the heat must be added to the ambient load. EER refers to the ambient unit only. The air flow of the units refers to the standard configuration with filter of the G3 class. The standard diameters of the pipes only apply for lengths – between the air conditioner and the condensing unit – up to 30 equivalent m.

Technical data and performances – chilled water unit – xxUC series, downward flow – 50Hz

MODEL		4LUC	6LUC	8LUC
power supply voltage	V/ph/Hz	230/1/50	400/3/50	400/3/50
PERFORMANCES (1)				
air flow	m ³ /s	0.64	0.80	1.31
available head	Pa	20	20	20
fan absorbed power	kW	0.6	0.5	1.2
fan absorbed current	A	2.6	3.3	5.4
SPL (Sound Pressure Level) (2)	dB(A)	49.8	51.4	51.7
coil inlet water temperature: 7 °C; outlet water temperature: 12 °C				
total cooling capacity	kW	7.6	11.9	17.9
sensible cooling capacity	kW	7.0	10.6	16.4
water flow	l/s	0.364	0.566	0.853
coil pressure drop	kPa	17	14	16
total pressure drop	kPa	28	24	25
SHR (sensible heat ratio)	–	0.92	0.89	0.92
coil inlet water temperature: 10 °C; outlet water temperature: 15 °C				
total cooling capacity	kW	5.4	8.2	12.7
sensible cooling capacity	kW	5.4	8.2	12.7
water flow	l/s	0.255	0.392	0.607
coil water pressure drop	kPa	9	8	10
total water pressure drop	kPa	15	13	14
SHR (sensible heat ratio)	–	1.00	1.00	1.00
FANS				
quantity	no.	1	1	1
type		dd 9/9	dd 10/10	dd 12/12
speed	no.	3	3	3
nominal power	kW	0.420	0.500	0.736
poles	no.	4	6	6
CHILLED WATER COIL				
quantity	no.	1	1	1
pipes/fins		copper/aluminium	copper/treated aluminium	
fins for inch/rows	no.	12/3	12/4	12/5
front surface	m ²	0.33	0.50	0.50
position		inclined		
DIMENSIONS				
length	mm	750	750	750
depth	mm	450	600	750
height	mm	1950	1950	1950
plan surface	m ²	0.34	0.45	0.56
WEIGHTS				
net	kg	145	175	255
gross	kg	155	185	305

1 ON THE FOLLOWING STANDARD CONDITIONS:

standard supply [voltage \pm 10%]; room conditions 24°C bs; 50% R.H. (17°C bu)

2 Measured in the front part at 1 m height, 2 m distance, referred to free field.

ATTENTION: the refrigerating outputs are meant after deduction of the heat taken from the fans, which must thus be added to the room load. The unit air flow refers in standard configuration with clean class filter G3.

Technical data and performances – chilled water unit –xxUC series, downward flow –60Hz

MODEL		4LUC	6LUC	8LUC
power supply voltage	V/ph/Hz	230/1/60	380/3/60	380/3/60
PERFORMANCES (1)				
air flow	m ³ /s	0.64	0.90	1.37
available head	Pa	20	20	20
fan absorbed power	kW	1.0	0.8	1.6
fan absorbed current	A	4.3	4.0	7.1
SPL (Sound Pressure Level) (2)	dB(A)	49.1	54.7	52.3
coil inlet water temperature: 7 °C; outlet water temperature: 12 °C				
total cooling capacity	kW	7.7	13.0	18.6
sensible cooling capacity	kW	7.1	11.6	17.0
water flow	l/s	0.367	0.620	0.885
coil pressure drop	kPa	17	16	17
total pressure drop	kPa	28	28	27
SHR (sensible heat ratio)	–	0.92	0.89	0.91
coil inlet water temperature: 10 °C; outlet water temperature: 15 °C				
total cooling capacity	kW	5.4	9.0	13.1
sensible cooling capacity	kW	5.4	9.0	13.1
water flow	l/s	0.257	0.428	0.627
coil water pressure drop	kPa	10	9	10
total water pressure drop	kPa	15	15	15
SHR (sensible heat ratio)	–	1.00	1.00	1.00
FANS				
quantity	no.	1	1	1
type		dd 9/9	dd 10/10	dd 12/12
speed	no.	3	3	3
nominal power	kW	0.420	0.500	0.736
poles	no.	4	6	6
CHILLED WATER COIL				
quantity	no.	1	1	1
pipes/fins		copper/aluminium	copper/treated aluminium	
fins for inch/rows	no.	12/3	12/4	12/5
front surface	m ²	0.33	0.50	0.50
position		inclined		
DIMENSIONS				
length	mm	750	750	750
depth	mm	450	600	750
height	mm	1950	1950	1950
plan surface	m ²	0.34	0.45	0.56
WEIGHTS				
net	kg	145	175	255
gross	kg	155	185	305

1 ON THE FOLLOWING STANDARD CONDITIONS:
standard supply [voltage \pm 10%]; room conditions 24°C bs; 50% R.H. (17°C bu)

2 Measured in the front part at 1 m height, 2 m distance, referred to free field.

ATTENTION: the refrigerating outputs are meant after deduction of the heat taken from the fans, which must thus be added to the room load. The unit air flow refers to high speed, in standard configuration with clean class filter G3.

Technical data and performances – chilled water unit – xxOC series, upward flow – 50Hz

MODEL		4LOC	6LOC	8LOC
power supply voltage	V/ph/Hz	230/1/50	400/3/50	400/3/50
PERFORMANCES (1)				
air flow	m ³ /s	0.59	0.73	1.13
available head	Pa	50	50	50
fan absorbed power	kW	0.5	0.5	1.1
fan absorbed current	A	2.5	3.1	4.7
SPL (Sound Pressure Level) (2)	dB(A)	52.3	54.1	55.1
coil inlet water temperature: 7 °C; outlet water temperature: 12 °C				
total cooling capacity	kW	6.9	10.8	15.4
sensible cooling capacity	kW	6.4	9.6	14.2
water flow	l/s	0.331	0.512	0.736
coil pressure drop	kPa	15	12	13
total pressure drop	kPa	24	20	20
SHR (sensible heat ratio)	–	0.92	0.89	0.92
coil inlet water temperature: 10 °C; outlet water temperature: 15 °C				
total cooling capacity	kW	4.9	7.4	11.0
sensible cooling capacity	kW	4.9	7.4	11.0
water flow	l/s	0.232	0.354	0.523
coil water pressure drop	kPa	8	7	8
total water pressure drop	kPa	12	11	12
SHR (sensible heat ratio)	–	1.00	1.00	1.00
FANS				
quantity	no.	1	1	1
type		dd 9/9	dd 10/10	dd 12/12
speed	no.	3	3	3
nominal power	kW	0.420	0.500	0.736
poles	no.	4	6	6
CHILLED WATER COIL				
quantity	no.	1	1	1
pipes/fins		copper/aluminium	copper/treated aluminium	
fins for inch/rows	no.	12/3	12/4	12/5
front surface	m ²	0.33	0.50	0.50
position		inclined		
DIMENSIONS				
length	mm	750	750	750
depth	mm	450	600	750
height	mm	1950	1950	1950
plan surface	m ²	0.34	0.45	0.56
WEIGHTS				
net	kg	145	175	255
gross	kg	155	185	305

1 ON THE FOLLOWING STANDARD CONDITIONS:

standard supply [voltage \pm 10%]; room conditions 24°C bs; 50% R.H. (17°C bu)

2 Measured in the front part at 1 m height, 2 m distance, referred to free field.

ATTENTION: the refrigerating outputs are meant after deduction of the heat taken from the fans, which must thus be added to the room load. The unit air flow refers to high speed, in standard configuration with clean class filter G3.

Technical data and performances – chilled water unit –xxUC series, downward flow –60H

MODEL		4LOC	6LOC	8LOC
power supply voltage	V/ph/Hz	230/1/60	380/3/60	380/3/60
PERFORMANCES (1)				
air flow	m ³ /s	0.61	0.85	1.28
available head	Pa	50	50	50
fan absorbed power	kW	1.0	0.8	1.4
fan absorbed current	A	4.1	3.7	6.2
SPL (Sound Pressure Level) (2)	dB(A)	51.7	59.7	55.7
coil inlet water temperature: 7 °C; outlet water temperature: 12 °C				
total cooling capacity	kW	7.2	12.0	17.0
sensible cooling capacity	kW	6.6	10.7	15.7
water flow	l/s	0.341	0.573	0.813
coil pressure drop	kPa	15	14	15
total pressure drop	kPa	25	25	23
SHR (sensible heat ratio)	–	0.92	0.89	0.92
coil inlet water temperature: 10 °C; outlet water temperature: 15 °C				
total cooling capacity	kW	5.0	8.3	12.1
sensible cooling capacity	kW	5.0	8.3	12.1
water flow	l/s	0.238	0.396	0.579
coil water pressure drop	kPa	8	8	9
total water pressure drop	kPa	13	13	13
SHR (sensible heat ratio)	–	1.00	1.00	1.00
FANS				
quantity	no.	1	1	1
type		dd 9/9	dd 10/10	dd 12/12
speed	no.	3	3	3
nominal power	kW	0.420	0.500	0.736
poles	no.	4	6	6
CHILLED WATER COIL				
quantity	no.	1	1	1
pipes/fins		copper/aluminium	copper/treated aluminium	
fins for inch/rows	no.	12/3	12/4	12/5
front surface	m ²	0.33	0.50	0.50
position		inclined		
DIMENSIONS				
length	mm	750	750	750
depth	mm	450	600	750
height	mm	1950	1950	1950
plan surface	m ²	0.34	0.45	0.56
WEIGHTS				
net	kg	145	175	255
gross	kg	155	185	305

1 ON THE FOLLOWING STANDARD CONDITIONS:
standard supply [voltage \pm 10%]; room conditions 24°C bs; 50% R.H. (17°C bu)

2 Measured in the front part at 1 m height, 2 m distance, referred to free field.

ATTENTION: the refrigerating outputs are meant after deduction of the heat taken from the fans, which must thus be added to the room load. The unit air flow refers to high speed, in standard configuration with clean class filter G3.

11 – Optional

11.1 – Filters

High efficiency filters G4 and F5, height 100 mm

The high efficiency (optional) filters, of the folded type, 100 mm height, interchangeable with the standard series, can be supplied in the two filtering classes G4 and F5 based on EN 779 (equivalent to European norms Eurovent 4/5).

These filters have a filtering power higher than the standard ones with a higher load loss.

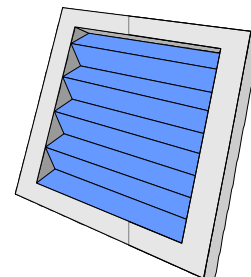

Features of the high efficiency filters

Filtering class		G4	F5
Spare part codes			
Models 4–5	[no.]	210144	210033
Models 6–7 under	[no.]	210149	210034
Models 8–9 under	[no.]	210149	210035
Models 6–7 over	[no.]	210147	210036
Models 8–9 over	[no.]	210148	210036
Height		100	100

High efficiency filters F6, F7 and F9, height 290 mm

The (optional) high efficiency filters, filtering class F6, F7 and F9 according to EN 779 (equivalent to European norms Eurovent 4/5), are made of fiber glass filtering materials. The filtering "V"–section plates with a solid peripheral frame can bear considerable pressure and flow changes.

Features of the high efficiency filters

Filtering class		F6	F7	F9
Spare part codes				
Models 4–5	[no.]	482740	482741	482742
Models 6–7	[no.]	482743	482744	482745
Models 8–9	[no.]	482746	482747	482748
Height	mm	290	290	290

Filter–holding duct

If filters with 290 mm height are required, a metal duct of the same colour (RAL7032) as the unit must be supplied as filter support to be installed on the machine top.

Models		4	6	8	5	7	9
Length	mm	750	750	750	1490	1490	1490
Depth	mm	450	600	750	450	600	750
Height	mm	450	450	450	450	450	450

Clogged filter alarm

A differential flow indicator, that can be calibrated, may be installed to inform the microprocessor control about the need to replace the filters when they are clogged.

Additional pressure drop (Pa)

The pressure drop described in the following tables must be subtracted from the heads given in the Useful available head tables of section "Aeraulic features".

Models 4–5 UNDER

Air flow [m ³ /s]	Δp G3 h=100	As REPLACEMENT of the filter G3		In ADDITION to the filter G3		
		Filters G4 h=100	Filters F5 h=100	Filters F6 h=290	Filters F7 h=290	Filters F9 h=290
0.350	17	4	66	36	48	65
0.400	21	6	77	46	60	78
0.450	26	7	90	57	73	92
0.500	31	9	103	68	87	107
0.550	37	10	117	81	102	122
0.600	42	12	130	94	118	138

Models 6–7 UNDER

Air flow [m ³ /s]	Δp G3 h=100	As REPLACEMENT of the filter G3		In ADDITION to the filter G3		
		Filters G4 h=100	Filters F5 h=100	Filters F6 h=290	Filters F7 h=290	Filters F9 h=290
0.600	25	7	87	40	58	67
0.650	29	8	96	46	65	76
0.700	33	9	106	52	73	84
0.750	37	11	116	59	81	93

Models 8–9 UNDER

Air flow [m ³ /s]	Δp G3 h=100	As REPLACEMENT of the filter G3		In ADDITION to the filter G3		
		Filters G4 h=100	Filters F5 h=100	Filters F6 h=290	Filters F7 h=290	Filters F9 h=290
0.950	36	10	114	56	75	93
1.000	40	11	122	62	82	100
1.050	43	12	130	68	89	108
1.100	47	13	138	76	96	115
1.150	50	15	145	83	103	123
1.200	54	16	154	91	111	132
1.250	58	17	162	100	119	140

Models 4–5 OVER

Air flow [m ³ /s]	Δp G3 h=100	As REPLACEMENT of the filter G3		In ADDITION to the filter G3		
		Filters G4 h=100	Filters F5 h=100	Filters F6 h=290	Filters F7 h=290	Filters F9 h=290
0.400	21	6	77	46	60	78
0.450	26	7	90	57	73	92
0.500	31	9	103	68	87	107
0.550	37	10	117	81	102	122
0.600	42	12	130	94	118	138

Models 6–7 OVER

Air flow [m ³ /s]	Δp G3 h=100	As REPLACEMENT of the filter G3		In ADDITION to the filter G3		
		Filters G4 h=100	Filters F5 h=100	Filters F6 h=290	Filters F7 h=290	Filters F9 h=290
0.550	11	2	48	34	51	59
0.600	13	3	54	40	58	67
0.650	15	4	60	46	65	76
0.700	17	4	65	52	73	84

Models 8–9 OVER

Air flow [m ³ /s]	Δp G3 h=100	As REPLACEMENT of the filter G3		In ADDITION to the filter G3		
		Filters G4 h=100	Filters F5 h=100	Filters F6 h=290	Filters F7 h=290	Filters F9 h=290
0.850	23	6	83	44	62	78
0.900	25	7	90	50	69	85
0.950	28	8	96	56	75	93
1.000	30	9	103	62	82	100
1.050	33	10	109	68	89	108
1.100	36	11	116	76	96	115
1.150	38	12	123	83	103	123

11.2 – HP–FAN

When high head values are necessary, the machines can be equipped with HP–FAN optional fans, replacing the standard fans.

By these fans it is possible to adjust the aeraulic performance (air delivery and head) from a max. to a min. value, through a potentiometer for the models 4–6–8, and through a setting by the Microface control for the models 5–7–9.

This feature enables an accurate calibration in the range of the working point required by the unit.

The operating tables for the optional fans mounted in the units, and adjusted at the highest speed with units equipped with G3 class clean filter follow here below.

The HP–FAN option is available for all the Hiflex models, except 4 MUA and 4 MOA.

Available static pressure at max speed –50 Hz

4SU A/W 5SU A/W		4LU A/W/C 5LU A/W		6SU A/W 7SU A/W		6LUA/W/C 7LU A/W		8SU A/W 9SU A/W		8LU A/W/C 9LU A/W		8LU /D/H/F 9LU /D/H/F	
Air flow [m ³ /s]	Available head [Pa]	Air flow [m ³ /s]	Available head [Pa]	Air flow [m ³ /s]	Available head [Pa]	Air flow [m ³ /s]	Available head [Pa]	Air flow [m ³ /s]	Available head [Pa]	Air flow [m ³ /s]	Available head [Pa]	Air flow [m ³ /s]	Available head [Pa]
0.350	282	0.350	282	0.575	330	0.575	330	0.950	215	0.950	215	0.800	219
0.375	264	0.375	264	0.600	320	0.600	320	0.975	208	0.975	208	0.850	203
0.400	249	0.400	249	0.625	309	0.625	309	1.00	201	1.00	201	0.900	187
0.425	235	0.425	235	0.650	298	0.650	298	1.025	193	1.025	193	0.950	169
0.450	221	0.450	221	0.675	287	0.675	287	1.050	186	1.050	186	1.000	150
0.460	215	0.475	207	0.700	275	0.700	275	1.075	178	1.075	178	1.050	130
0.475	207	0.500	193	0.725	264	0.725	264	1.100	169	1.100	169	1.100	109
0.500	193	0.525	178	0.743	255	0.750	252	1.125	161	1.125	161	1.150	86
0.525	178	0.550	161	0.750	252	0.775	238	1.150	152	1.150	152	1.200	62
0.550	161	0.575	142	0.775	238	0.800	224	1.175	143	1.175	143	1.220	51
0.575	142	0.600	120	0.800	224	0.825	210	1.200	133	1.200	133	1.250	36
0.600	120	0.625	95	0.825	210	0.850	193	1.210	129	1.225	123	1.300	8
0.625	95	0.640	78	0.850	193	0.875	175	1.225	123	1.250	113		
0.650	65	0.650	65	0.875	175	0.900	156	1.250	113	1.275	102		
0.675	31	0.675	31	0.900	156	0.925	135	1.275	102	1.300	91		
				0.925	135	0.950	112	1.300	91	1.310	87		
				0.950	112	0.975	86	1.325	80	1.325	80		
				0.975	86	1.000	59	1.350	68	1.350	68		
				1.000	59	1.025	29	1.375	56	1.375	56		
				1.025	29			1.400	43	1.400	43		
								1.425	30	1.425	30		
								1.450	16	1.450	16		
								1.475	2	1.475	2		

4SO A/W 5SO A/W		4LO A/W/C 5LO A/W		6SO A/W 7SO A/W		6LO A/W/C 7LO A/W		8SO A/W 9SO A/W		8LO A/W/C 9LO A/W		8LO /D/H/F 9LO /D/H/F	
Air flow	Available head	Air flow	Available head	Air flow	Available head	Air flow	Available head	Air flow	Available head	Air flow	Available head	Air flow	Available head
[m³/s]	[Pa]	[m³/s]	[Pa]	[m³/s]	[Pa]	[m³/s]	[Pa]	[m³/s]	[Pa]	[m³/s]	[Pa]	[m³/s]	[Pa]
0.375	253	0.375	253	0.475	376	0.475	376	0.875	189	0.875	189	0.800	191
0.400	235	0.400	235	0.500	362	0.500	362	0.900	180	0.900	180	0.840	175
0.425	219	0.425	219	0.525	349	0.525	349	0.925	171	0.925	171	0.880	159
0.450	203	0.450	203	0.550	336	0.550	336	0.950	161	0.950	161	0.920	142
0.475	188	0.475	188	0.575	324	0.575	324	0.975	152	0.975	152	0.960	124
0.500	172	0.500	172	0.600	312	0.600	312	1.000	142	1.000	142	1.000	106
0.525	154	0.525	154	0.625	301	0.625	301	1.025	131	1.025	131	1.040	89
0.550	135	0.550	135	0.650	289	0.650	289	1.050	121	1.050	121	1.050	80
0.575	114	0.589	100	0.675	278	0.675	278	1.075	110	1.075	110	1.080	69
0.600	89	0.575	114	0.678	276	0.700	266	1.080	107	1.100	98	1.120	48
0.625	61	0.600	89	0.700	266	0.725	253	1.100	98	1.125	86	1.160	25
0.650	28	0.625	61	0.725	253	0.730	251	1.125	86	1.150	74	1.200	0
		0.650	28	0.750	240	0.750	240	1.150	74	1.175	61		
				0.775	227	0.775	227	1.175	61	1.200	48		
				0.800	212	0.800	212	1.200	48	1.225	35		
				0.825	196	0.825	196	1.225	35	1.250	21		
				0.850	179	0.850	179	1.250	21	1.275	6		
				0.875	160	0.875	160	1.275	6				
				0.900	140	0.900	140						
				0.925	117	0.925	117						
				0.950	93	0.950	93						
				0.975	67	0.975	67						
				1.000	38	1.000	38						
				1.025	7	1.025	7						

4SC A/W		4LC A/W		6SC A/W		8SC A/W	
Air flow	Available head	Air flow	Available head	Air flow	Available head	Air flow	Available head
[m³/s]	[Pa]	[m³/s]	[Pa]	[m³/s]	[Pa]	[m³/s]	[Pa]
0.300	318	0.375	230	0.800	182	0.375	455
0.325	293	0.400	203	0.825	172	0.400	441
0.350	267	0.425	178	0.850	161	0.425	426
0.360	257	0.450	155	0.875	151	0.450	411
0.375	241	0.475	136	0.900	140	0.475	396
0.400	215	0.500	119	0.925	128	0.500	382
0.425	191	0.525	101	0.950	117	0.525	370
0.450	170	0.530	97	0.970	107	0.550	359
0.475	153	0.550	81	0.975	105	0.575	349
0.500	137	0.575	56	1.000	92	0.600	341
0.525	122	0.600	26	1.025	79	0.625	335
0.550	103			1.050	66	0.650	328
0.575	80			1.075	53	0.675	321
0.600	53			1.100	39	0.680	319
0.625	21			1.125	24	0.700	312
				1.150	9	0.725	302
						0.750	289
						0.775	274
						0.800	256
						0.825	237
						0.850	216
						0.875	193
						0.900	168
						0.925	142
						0.950	114
						0.970	91
						0.975	85
						1.000	55
						1.025	23

Available static pressure at max speed – 60 Hz

4SU A/W 5SU A/W		4LU A/W/C 5LU A/W		6SU A/W 7SU A/W		6LUA/W/C 7LU A/W		8SU A/W 9SU A/W		8LU A/W/C 9LU A/W		8LU D/H/F 9LU D/H/F	
Air flow [m³/s]	Available head [Pa]	Air flow [m³/s]	Available head [Pa]	Air flow [m³/s]	Available head [Pa]	Air flow [m³/s]	Available head [Pa]	Air flow [m³/s]	Available head [Pa]	Air flow [m³/s]	Available head [Pa]	Air flow [m³/s]	Available head [Pa]
0.275	515	0.375	424	0.375	470	0.375	470						
0.300	493	0.400	404	0.400	456	0.400	456						
0.325	470	0.425	384	0.425	443	0.425	443						
0.350	445	0.450	365	0.450	432	0.450	432						
0.375	418	0.475	348	0.475	422	0.475	422						
0.400	388	0.500	332	0.500	414	0.500	414						
0.425	357	0.525	317	0.525	407	0.525	407						
0.450	326	0.550	302	0.550	401	0.550	401						
0.475	297	0.575	287	0.575	395	0.575	395						
0.500	271	0.600	270	0.600	389	0.600	389						
0.525	251	0.625	251	0.625	380	0.625	380						
0.550	234	0.640	239	0.650	368	0.650	368						
0.575	213	0.650	230	0.675	354	0.675	354						
0.600	171	0.675	204	0.700	336	0.700	336						
0.625	70	0.700	175	0.725	316	0.725	316						
0.632	20	0.725	143	0.750	293	0.750	293						
0.635	0	0.750	108	0.775	268	0.775	268						
		0.775	70	0.800	241	0.800	241						
		0.800	31	0.810	230	0.825	213						
		0.807	20	0.825	213	0.850	185						
		0.819	0	0.850	185	0.875	155						
				0.875	155	0.900	123						
				0.900	123	0.925	87						
				0.925	87	0.950	46						
				0.950	46	0.965	20						
				0.965	20	0.975	0						
				0.975	0								

4SO A/W 5SO A/W		4LO A/W/C 5LO A/W		6SO A/W 7SO A/W		6LO A/W/C 7LO A/W		8SO A/W 9SO A/W		8LO A/W/C 9LO A/W		8LO D/H/F 9LO D/H/F	
Air flow [m³/s]	Available head [Pa]	Air flow [m³/s]	Available head [Pa]	Air flow [m³/s]	Available head [Pa]	Air flow [m³/s]	Available head [Pa]	Air flow [m³/s]	Available head [Pa]	Air flow [m³/s]	Available head [Pa]	Air flow [m³/s]	Available head [Pa]
0.275	509	0.375	412	0.375	467	0.375	467						
0.300	485	0.400	390	0.400	453	0.400	453						
0.325	461	0.425	368	0.425	440	0.425	440						
0.350	435	0.450	348	0.450	428	0.450	428						
0.375	406	0.475	328	0.475	417	0.475	417						
0.400	374	0.500	310	0.500	409	0.500	409						
0.425	341	0.525	293	0.525	402	0.525	402						
0.450	308	0.550	276	0.550	395	0.550	395						
0.475	277	0.575	258	0.575	389	0.575	389						
0.500	250	0.600	239	0.600	381	0.600	381						
0.525	227	0.610	231	0.625	372	0.625	372						
0.549	208	0.625	218	0.650	360	0.650	360						
0.550	207	0.650	193	0.675	345	0.675	345						
0.572	188	0.675	165	0.700	327	0.700	327						
0.575	184	0.700	133	0.725	305	0.725	305						
0.597	147	0.725	98	0.750	281	0.750	281						
0.623	50	0.750	59	0.770	261	0.775	256						
0.622	53	0.756	50	0.775	256	0.800	228						
0.630	0	0.775	18	0.800	228	0.825	200						
		0.786	0	0.825	200	0.850	170						
				0.850	170	0.875	140						
				0.875	140	0.900	107						
				0.900	107	0.925	70						
				0.925	70	0.938	50						
				0.938	50	0.950	28						
				0.950	28	0.965	0						

4SC A/W		4LC A/W		6SC A/W		8SC A/W	
Air flow [m ³ /s]	Available head [Pa]	Air flow [m ³ /s]	Available head [Pa]	Air flow [m ³ /s]	Available head [Pa]	Air flow [m ³ /s]	Available head [Pa]
0.275	469	0.375	373	0.375	433		
0.300	438	0.400	345	0.400	414		
0.325	406	0.425	318	0.425	395		
0.350	370	0.450	291	0.450	378		
0.375	332	0.475	266	0.475	362		
0.380	324	0.500	241	0.500	348		
0.400	290	0.525	216	0.525	334		
0.425	247	0.530	211	0.550	321		
0.450	202	0.550	192	0.575	308		
0.475	159	0.575	166	0.600	293		
0.500	119	0.600	139	0.625	276		
0.525	83	0.625	109	0.640	265		
0.549	50	0.650	76	0.650	256		
0.550	49	0.668	50	0.675	233		
0.572	16	0.675	38	0.700	207		
0.575	11	0.699	0	0.725	177		
0.581	0			0.750	144		
				0.775	108		
				0.800	71		
				0.814	50		
				0.825	33		
				0.846	0		

11.3 – Reheating and humidity control (optional)

Electrical heating (and dehumidification system)

The electrical heaters can largely keep the correct temperature with dry bulb. The elements are made of aluminum with high efficiency fins to keep a low power density on the surfaces. The ionization effects are removed thanks to the low surface temperature of the elements.

The stages of the electrical heaters are distributed on the 3 phases to avoid balancing problems.

There are three steps, two contactors, temperature electronic control of the ON–OFF type, safety thermostat with manual reset, magnetothermal switch against short circuits, harness protection against possible casual contacts.

When the electrical heating is installed, the dehumidification system is operating as well, and the relevant humidity sensor and indicator are provided (see "Humidification and dehumidification system" for the dehumidification function).

It is possible to install the electric heating matched with the hot gas or hot water reheating. In this case, refer to the paragraph "Hot gas reheating" or "Hot water heating".

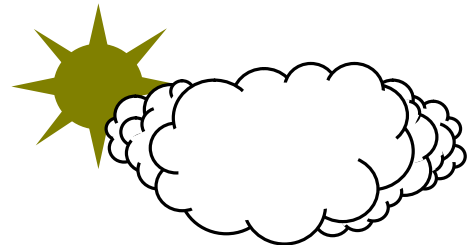

Heating capacity (400V/3ph/50Hz)

Models		4	6	8	5	7	9
3 steps, total power	[kW]	4.5	4.5	4.5	9.0	9.0	9.0
2 steps	[kW]	3.0	3.0	3.0	6.0	6.0	6.0
1 step	[kW]	1.5	1.5	1.5	3.0	3.0	3.0

Hot gas reheating (and A/W/D/F/H unit optional dehumidification system)

Hiflex can be supplied with a reheating system using the heat that is normally sent to the condenser to heat the air, saving energy. This system is activated during dehumidification (in fact, the relevant humidity sensors and indicators are provided) when the temperature decreases under the set value: in this way no additional energy is required for the reheating.

A control valve prevents the refrigerant from flowing into the reheating coil when this is not required. The hot gas reheating is available as an alternative to the hot water heating. For the “Constant” unit the hot gas system is of series, the hot water system is not available.

Operation mode of the electrical heating and the hot gas reheating

Dehumidification function			
first step		second step	
ON	OFF	ON	OFF
hot gas reheating	electric heating 1 st power step	hot gas reheating + 2 power step electric heating	electric heating 3 rd power step

Hot gas system features

Models		4		6		8		5		7		9	
		S	L	S	L	S	L	S	L	S	L	S	L
coil rows (each coil)	[no.]	1		1		1		2		2		2	
coil surface	[m ²]	0.22		0.33		0.33		0.44		0.66		0.66	
heating power with room temperature of 24°C, humidity 50%, condensation temperature 45°C	[kW]	3,4	5,1	6,3	7,3	8,2	9,9	6,9	10,2	12,7	14,7	16,4	19,9

Hot water heating (and dehumidification system)

The hot water heating coil made of copper pipes and aluminum fins, single row, testing pressure 30 bar, includes an exhaust valve. A three–way on–off valve is supplied as standard. It is directly controlled by a microprocessor as a function of the room temperature and by a hot water thermostat (to be supplied by the customer).

When the hot water heating is installed, the dehumidification system is operating as well and the relevant humidity sensor and indicator are provided (see “Humidification and dehumidification system” for the dehumidification function).

The hot water heating system is an alternative to the hot gas reheating system. For the “Constant” unit the hot gas system is of series, the hot water system is not available.

Operation mode of the electric heating and the hot water reheating

Dehumidification function			
first step		second step	
ON	OFF	ON	OFF
hot water reheating	electric heating 1 st power step	hot water reheating + 2 power step electric heating	electric heating 3 rd power step

Performances of DX units in post–heating ⁽¹⁾ – 50/60 Hz

UNDER MODELS Single circuit		4 M/U/A	4 SP/U/AW	4 LG/U/AW	6 SP/U/AW	6 LG/U/AW	8 SP/U/AW	8 LG/U/ AWDHF
rows	[no.]	1	1	1	1	1	1	1
front surface	[m ²]	0.22	0.22	0.22	0.33	0.33	0.33	0.33
ambient temp. 24°C, 50% R.H. water inlet/outlet temperature 80/65°C.								
power	[kW]	5.7	7.1	7.0	11.1	12.2	14.4	15.0
water flow	[l/s]	0.09	0.11	0.11	0.18	0.20	0.24	0.25
coil side pressure drops	[kPa]	1	1	1	2	2	2	2
total pressure drops	[kPa]	1	1	1	2	2	2	2
ambient temp. 20°C, 50% R.H. water inlet/outlet temperature 80/65°C.								
power	[kW]	6.1	7.6	7.5	11.8	13.0	15.3	16.0
water flow	[l/s]	0.10	0.12	0.12	0.19	0.21	0.25	0.26
coil side pressure drops	[kPa]	1	1	1	2	2	3	3
total pressure drops	[kPa]	1	2	2	2	3	4	4
OVER MODELS Single circuit		4 M/O/A	4 SP/O/AW	4 LG/O/AW	6 SP/O/AW	6 LG/O/AW	8 SP/O/AW	8 LG/O/ AWDHF
rows	[no.]	1	1	1	1	1	1	1
front surface	[m ²]	0.22	0.22	0.22	0.33	0.33	0.33	0.33
ambient temp. 24°C, 50% R.H. water inlet/outlet temperature 80/65°C.								
power	[kW]	5.7	6.7	6.8	10.9	11.7	14.1	14.3
water flow	[l/s]	0.09	0.11	0.11	0.18	0.19	0.23	0.24
coil side pressure drops	[kPa]	1	1	1	1	2	2	2
total pressure drops	[kPa]	1	1	1	2	2	3	3
ambient temp. 20°C, 50% R.H. water inlet/outlet temperature 80/65°C.								
power	[kW]	6.1	7.1	7.3	11.6	12.4	15.0	15.3
water flow	[l/s]	0.10	0.11	0.12	0.19	0.20	0.25	0.25
coil side pressure drops	[kPa]	1	1	1	2	2	2	3
total pressure drops	[kPa]	1	1	1	2	3	3	4
UNDER MODELS Double circuit		5 SP/U/AW	5 LG/U/AW	7 SP/U/AW	7 LG/U/AW	9 SP/U/AW	9 LG/U/ AWDHF	
rows	[no.]	1	1	1	1	1	1	
front surface	[m ²]	0.44	0.44	0.66	0.66	0.66	0.66	
ambient temp. 24°C, 50% R.H. water inlet/outlet temperature 80/65°C.								
power	[kW]	14.2	13.8	22.1	24.2	28.6	29.9	
water flow	[l/s]	0.23	0.23	0.37	0.40	0.47	0.50	
coil side pressure drops	[kPa]	1	1	2	2	3	3	
total pressure drops	[kPa]	2	2	3	3	4	4	
ambient temp. 20°C, 50% R.H. water inlet/outlet temperature 80/65°C.								
power	[kW]	15.2	14.8	23.6	25.9	30.4	32.0	
water flow	[l/s]	0.25	0.24	0.39	0.43	0.51	0.53	
coil side pressure drops	[kPa]	1	1	2	2	3	3	
total pressure drops	[kPa]	2	2	3	3	4	5	

OVER MODELS Double circuit		5 SP/O/AW	5 LG/O/AW	7 SP/O/AW	7 LG/O/AW	9 SP/O/AW	9 LG/O/ AWDHF
rows	[no.]	1	1	1	1	1	1
front surface	[m ²]	0.44	0.44	0.66	0.66	0.66	0.66
ambient temp. 24°C, 50% R.H. water inlet/outlet temperature 80/65°C.							
power	[kW]	13.3	13.7	17.0	16.9	27.1	28.5
water flow	[l/s]	0.22	0.22	0.28	0.28	0.45	0.47
coil side pressure drops	[kPa]	1	1	1	1	3	3
total pressure drops	[kPa]	1	1	2	2	3	4
ambient temp. 20°C, 50% R.H. water inlet/outlet temperature 80/65°C.							
power	[kW]	14.2	14.6	18.2	18.0	29.0	30.5
water flow	[l/s]	0.23	0.24	0.30	0.30	0.48	0.51
coil side pressure drops	[kPa]	1	1	2	1	3	3
total pressure drops	[kPa]	2	2	2	2	4	4

NOTE Standard air flow. Available head: Under=20 Pa; Over=30 Pa.
Hot water coil connections ø 18 mm.

(1) Condensation temperature 45°C.

Performances of DX units heating only – 50/60 Hz

UNDER MODELS Single circuit		4 M/U/A	4 SP/U/AW	4 LG/U/AW	6 SP/U/AW	6 LG/U/AW	8 SP/U/AW	8 LG/U/ AWDHF
rows	[no.]	1	1	1	1	1	1	1
front surface	[m ²]	0.22	0.22	0.22	0.33	0.33	0.33	0.33
ambient temp. 24°C, 50% R.H. water inlet/outlet temperature 80/65°C.								
power	[kW]	5.6	5.9	7.2	9.1	9.7	12.3	12.9
water flow	[l/s]	0.09	0.09	0.12	0.15	0.16	0.20	0.21
coil side pressure drops	[kPa]	1	1	1	1	1	2	2
total pressure drops	[kPa]	1	1	1	2	2	2	3
ambient temp. 20°C, 50% R.H. water inlet/outlet temperature 80/65°C.								
power	[kW]	6.1	6.5	7.9	10.0	10.7	13.6	14.2
water flow	[l/s]	0.10	0.10	0.13	0.16	0.17	0.22	0.23
coil side pressure drops	[kPa]	1	1	1	1	1	2	2
total pressure drops	[kPa]	1	1	2	2	2	3	3

OVER MODELS Single circuit		4 M/O/A	4 SP/O/AW	4 LG/O/AW	6 SP/O/AW	6 LG/O/AW	8 SP/O/AW	8 LG/O/ AWDHF
rows	[no.]	1	1	1	1	1	1	1
front surface	[m ²]	0.22	0.22	0.22	0.33	0.33	0.33	0.33
ambient temp. 24°C, 50% R.H. water inlet/outlet temperature 80/65°C.								
power	[kW]	4.8	5.5	6.8	8.8	9.2	11.6	11.8
water flow	[l/s]	0.08	0.09	0.11	0.14	0.15	0.19	0.19
coil side pressure drops	[kPa]	1	1	1	1	1	2	2
total pressure drops	[kPa]	1	1	1	1	2	3	3
ambient temp. 20°C, 50% R.H. water inlet/outlet temperature 80/65°C.								
power	[kW]	5.3	6.0	7.5	9.7	10.1	12.8	13.0
water flow	[l/s]	0.08	0.10	0.12	0.16	0.16	0.21	0.21
coil side pressure drops	[kPa]	1	1	1	1	1	2	3
total pressure drops	[kPa]	1	1	2	2	2	3	3

UNDER MODELS Double circuit		5 SP/U/AW	5 LG/U/AW	7 SP/U/AW	7 LG/U/AW	9 SP/U/AW	9 LG/U/ AWDHF
rows	[no.]	1	1	1	1	1	1
front surface	[m ²]	0.44	0.44	0.66	0.66	0.66	0.66
ambient temp. 24°C, 50% R.H. water inlet/outlet temperature 80/65°C.							
power	[kW]	11.7	14.3	18.2	19.3	24.5	25.7
water flow	[l/s]	0.19	0.23	0.30	0.32	0.41	0.43
coil side pressure drops	[kPa]	1	1	2	2	2	2
total pressure drops	[kPa]	1	2	2	2	3	3
ambient temp. 20°C, 50% R.H. water inlet/outlet temperature 80/65°C.							
power	[kW]	12.8	15.8	20.0	21.2	27.0	28.2
water flow	[l/s]	0.21	0.26	0.33	0.35	0.45	0.47
coil side pressure drops	[kPa]	1	2	2	2	3	3
total pressure drops	[kPa]	1	2	2	2	3	4
OVER MODELS Double circuit		5 SP/O/AW	5 LG/O/AW	7 SP/O/AW	7 LG/O/AW	9 SP/O/AW	9 LG/O/ AWDHF
rows	[no.]	1	1	1	1	1	1
front surface	[m ²]	0.44	0.44	0.66	0.66	0.66	0.66
ambient temp. 24°C, 50% R.H. water inlet/outlet temperature 80/65°C.							
power	[kW]	10.9	13.6	17.5	18.3	21.9	23.4
water flow	[l/s]	0.18	0.22	0.29	0.30	0.36	0.39
coil side pressure drops	[kPa]	1	1	1	2	2	2
total pressure drops	[kPa]	1	1	2	2	3	3
ambient temp. 20°C, 50% R.H. water inlet/outlet temperature 80/65°C.							
power	[kW]	12.1	15.0	19.3	20.1	24.1	25.8
water flow	[l/s]	0.20	0.25	0.32	0.33	0.40	0.43
coil side pressure drops	[kPa]	1	1	2	2	2	2
total pressure drops	[kPa]	1	2	2	2	3	3

NOTE Standard air flow. Available head: Under=20 Pa; Over=30 Pa.
Hot water coil connections ø 18 mm.

Performances of CW units in post–heating ⁽¹⁾ – 50/60 Hz

C UNDER MODELS		4LUC	6LUC	8LUC
air flow rate	[m ³ /s]	0.639	0.800	1.310
rows	[no.]	1	1	1
front surface	[m ²]	0.22	0.33	0.33
ambient temp. 24°C, 50% R.H. water inlet/outlet temperature 80/65°C.				
power	[kW]	8.8	12.4	16.3
water flow	[l/s]	0.140	0.200	0.270
coil side pressure drops	[kPa]	2	2	3
total pressure drops	[kPa]	2	3	4
ambient temp. 20°C, 50% R.H. water inlet/outlet temperature 80/65°C.				
power	[kW]	9.0	12.5	16.5
water flow	[l/s]	0.150	0.200	0.270
coil side pressure drops	[kPa]	2	2	2
total pressure drops	[kPa]	2	3	4
C OVER MODELS		4LOC	6LOC	8LOC
air flow rate	[m ³ /s]	0.590	0.731	1.130
rows	[no.]	1	1	1
front surface	[m ²]	0.22	0.33	0.33
ambient temp. 24°C, 50% R.H. water inlet/outlet temperature 80/65°C.				
power	[kW]	8.4	11.8	14.9
water flow	[l/s]	0.140	0.190	0.240
coil side pressure drops	[kPa]	2	2	2
total pressure drops	[kPa]	2	2	3
ambient temp. 20°C, 50% R.H. water inlet/outlet temperature 80/65°C.				
power	[kW]	8.6	11.8	15.0
water flow	[l/s]	0.140	0.190	0.250
coil side pressure drops	[kPa]	2	2	2
total pressure drops	[kPa]	2	2	4

NOTE Standard air flow. Available head: Under=20 Pa; Over=30 Pa.
Hot water coil connections ø 18 mm.

(1) Chilled water in/out 7/12°C.

Performances of CW units heating only – 50/60 Hz

C UNDER MODELS		4LUC	6LUC	8LUC
air flow rate	[m ³ /s]	0.639	0.800	1.310
rows	[no.]	1	1	1
front surface	[m ²]	0.22	0.33	0.33
ambient temp. 24°C, 50% R.H. water inlet/outlet temperature 80/65°C.				
power	[kW]	7.2	9.7	12.9
water flow	[l/s]	0.120	0.160	0.210
coil side pressure drops	[kPa]	1	1	2
total pressure drops	[kPa]	1	2	3
ambient temp. 20°C, 50% R.H. water inlet/outlet temperature 80/65°C.				
power	[kW]	7.9	10.7	14.2
water flow	[l/s]	0.130	0.170	0.230
coil side pressure drops	[kPa]	1	1	2
total pressure drops	[kPa]	2	2	3

C OVER MODELS		4LOC	6LOC	8LOC
air flow rate	[m ³ /s]	0.590	0.731	1.130
rows	[no.]	1	1	1
front surface	[m ²]	0.22	0.33	0.33
ambient temp. 24°C, 50% R.H. water inlet/outlet temperature 80/65°C.				
power	[kW]	6.8	9.2	11.8
water flow	[l/s]	0.110	0.150	0.190
coil side pressure drops	[kPa]	1	1	2
total pressure drops	[kPa]	1	2	2
ambient temp. 20°C, 50% R.H. water inlet/outlet temperature 80/65°C.				
power	[kW]	7.5	10.1	13.0
water flow	[l/s]	0.120	0.160	0.210
coil side pressure drops	[kPa]	1	1	2
total pressure drops	[kPa]	2	2	3

NOTE Standard air flow. Available head: Under=20 Pa; Over=30 Pa.
Hot water coil connections ø 18 mm.

Additional pressure drop (Pa)

The pressure drop described in the following tables must be subtracted from the available heads reported in the Useful available head tables of section "Aeraulic features".

Model UNDER

Models 4–5		Models 6–7		Models 8–9	
Air flow	Δp Hot water or hot gas reheating coil	Air flow	Δp Hot water or hot gas reheating coil	Air flow	Δp Hot water or hot gas reheating coil
[m ³ /s]	[Pa]	[m ³ /s]	[Pa]	[m ³ /s]	[Pa]
0.350	4	0.550	2	0.950	5
0.400	5	0.600	2	1.000	5
0.450	6	0.650	3	1.050	6
0.500	7	0.700	3	1.100	6
0.550	8	0.750	3	1.150	7
0.600	9	0.800	4	1.200	7

Model OVER

Models 4–5		Models 6–7		Models 8–9	
Air flow	Δp Hot water or hot gas reheating coil	Air flow	Δp Hot water or hot gas reheating coil	Air flow	Δp Hot water or hot gas reheating coil
[m ³ /s]	[Pa]	[m ³ /s]	[Pa]	[m ³ /s]	[Pa]
0.400	2	0.500	2	0.850	4
0.450	3	0.550	2	0.900	5
0.500	3	0.600	2	0.950	5
0.550	4	0.650	3	1.000	5
0.600	4	0.700	3	1.050	6
0.650	5	0.750	3	1.100	6

11.4 – Humidification and dehumidification system

The humidification system needs the installation of the electronic humidifier HUMIDAIR.

The dehumidification function, currently supplied when the humidifier option is installed, is obtained by switching on the compressor and reducing the fan speed, with a consequent reduction of the air flow (in the models A and W) or completely opening the 3-way valve of the refrigerated water (in the models C).

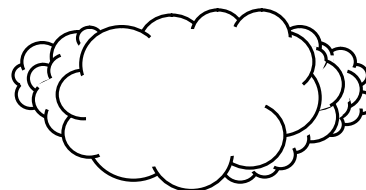

Humidity electronic control

The software of the microprocessor control Hiromatic includes the algorithm which controls the electronic modulating humidifier HUMIDAIR and provides for the dehumidification function.

There is also a special function which automatically excludes the dehumidification function if the temperature decreases under the required values; when the temperature reaches the correct values, the dehumidification function is automatically restored.

The dehumidification control can be of the proportional or on-off type, depending on the requirements for any installation; the on-off system is set by the manufacturer as standard.

Electric steam humidifier HUMIDAIR

HUMIDAIR is a steam cylinder with immersed electrodes which enables the production of the necessary steam quantity.

It can use any sort of water (with different hardness), provided that it is not treated or demineralized. It produces almost instantaneously particle-free clean steam, making electric current pass through the water contained in the plastic cylinder that can be replaced, avoiding energy losses typical of other systems. HUMIDAIR is provided with the steam cylinder, water inlet and outlet valves, max. level sensor. The steam output can be adjusted within a range of values that can be selected manually and are set by the manufacturer at 70% of the max. power (see relevant features).

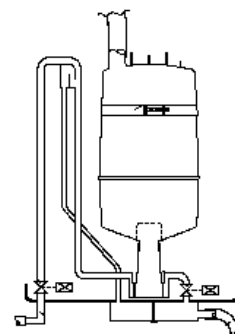

Features of the electronic humidifier

The steam cylinder is installed outside the air flow so as to avoid heat losses; the steam is mixed with the delivery air of the evaporating coil by the suitable distributor.

The Hiromatic control can determine when the cylinder must be replaced.

The replacement is quite simple and quick. A self-adaptive flow control system is installed as standard and controls the current passing through the cylinder water.

HUMIDAIR HAK53H is used for applications at 400 Volt, the model HAK53L, instead, is for 230 Volt.

HIFLEX MODEL	HUMIDAIR MODEL	MAIN POWER SUPPLIES	SETTING BAND [kg/h]	NOMINAL CURRENT [A]	NOMINAL POWER [kW]
4-5	HAK21L	230 V \pm 1 ph/50-60 Hz	0.6-2.0	6.5	1.5
6-8-7-9	HAK53H	400 V \pm 3 ph/50-60 Hz	1.3-4.5	5.0	3.4
6-8-7-9	HAK53L*	230 V \pm 3 ph/50-60 Hz	1.2-4.2	8.2	3.1

* Special configuration on request.

11.5 – Water control valve (models W/H)

A modulating valve controls the condensation pressure by controlling the water flow to the plate condenser. It is installed at the condenser outlet with the pressure probe in the refrigerant drain line. It is automatically closed when the compressor is not working.

It provides for cost saving reducing water consumption. It is sized for inlet water flow temperature values lower than 17 °C (well water) ensuring a low value for pressure drop.

To define a proper water flow value depending on the specific operation features, refer to the performance tables of the units W.

For higher water inlet temperatures (tower water) there must be higher water flows; if the water control valve is required for these special conditions, see the section "Special water control valves" in the section of the "Special configurations".

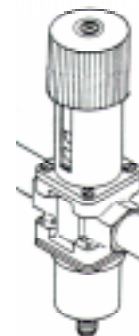

Water control valve features

Models		4–5 W	6–7 W	8–9 W/H
outlet connections	inch BSP int.	1/2"	3/4"	3/4"
code		378201	378202	378202
valve pressure drop at 0.05 l/s	kPa	1		
valve pressure drop at 0.1 l/s	kPa	4	2	
valve pressure drop at 0.2 l/s	kPa	14	5	5
valve pressure drop at 0.3 l/s	kPa		12	12
valve pressure drop at 0.4 l/s	kPa			22

11.6 – Flooding alarm (Liquistat)

The flooding alarm perceives the presence of water or another conductive liquid and, by opening a circuit, it causes an alarm.

There are no moving parts and it is not subject to dirt or vibrations. Several sensors can be connected to the same flooding alarm device to control many points in the room. The alarm device is supplied with a sensor. Additional sensors can be ordered separately.

11.7 – Smoke alarm (Smokestat)

A smoke alarm can be installed to close the conditioning system when the presence of smoke in the return air is perceived.

This is an optic smoke detector (it uses the Tyndall effect), which absorbs a current with very low intensity (100 µA), totally insensitive to light or wind.



11.8 – Fire alarm (Firestat)

In some applications, the fire prevention norms require the installation of an alarm device (Firestat) that disables the conditioner if the return air temperature is particularly high.

This detector provided with an NTC thermistor has a very low current absorption (25–55 µA).

11.9 – Fresh air

The fresh air kit, with its own filter G3, installed on the fan suction side, has a connection with a plastic pipe with 100 mm diameter. The connection is placed in the lower part of the unit for an easier and quicker installation.

As it is positioned on the fan suction, the fresh air will easily mix with the recirculated air.

Models	Clean (dirty) filter fresh air ** (l/s)	
	Clean	Dirty
4S/M/P U	28 (24)	22 (20)
4L/G U	29 (25)	22 (20)
6S/P U	26 (23)	20 (19)
6L/G U	28 (24)	21 (20)
8S/P U	29 (25)	22 (21)
8L/G U	32 (28)	24 (22)
4S/M/P O/C	22 (20)	17 (15)
4L/G O/C	23 (21)	18 (17)
6S/P O/C	24 (21)	18 (17)
6L/G O	25 (22)	19 (18)
8S/P O/C	26 (23)	20 (19)
8L/G O	28 (24)	21 (20)
5S/M/P U	56 (48)	44 (20)
5L/G U	58 (50)	22 (20)
7S/P U	52 (46)	20 (38)
7L/G U	56 (48)	42 (40)
9S/P U	58 (50)	44 (42)
9L/G U	64 (56)	48 (44)
5S/M/P O	44 (40)	34 (30)
5L/G O	46 (42)	36 (34)
7S/P O	48 (42)	36 (34)
7L/G O	50 (44)	38 (36)
9S/P O	52 (46)	40 (38)
9L/G O	56 (48)	42 (40)
Suction pipe equivalent length* (m)	12	24

* A 90° bend corresponds to approx. 2 m linear duct.

** Suction pipe diameter $\phi=100\text{mm}$

11.10 – Suction and delivery ducts

Hiflex can be provided with suction and delivery ducts on the top in order to be connected to a false ceiling. The air duct is made so as to keep the same appearance of the machine; the height (min. 600, max. 1200 mm) can be defined when the machine is ordered.

The duct is lined with deadening material to reduce the sound emission through the outlet air opening.

The maximum sound reduction, which can be obtained with 1200–mm–high ducts, is -5.5 dB(A) at 2 m in front of the machine (instrument positioned at 1.5 m from the floor) and -0.5 dB(A) at 1 m and at 45° with respect to the horizontal delivery plane of the machine, with free opening (not ducted).

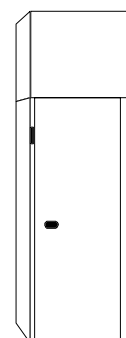

11.11 – Deadening cartridges for delivery channels – *Silent Carts* (models Over)

These are special cartridges made of self-extinguishing material with high deadening power. They are guaranteed against particle disaggregation and release as a result of the friction with the channel air. The pressure drop due to the introduction of these cartridges in the channel are low in comparison with the advantages resulting from the noise reduction.

One or two cartridge rows can be installed in the delivery channel: for channel heights between 600 mm and 1100 mm one single rank, whereas for channel heights between 1100 mm and 1200 mm one or two rows, by simply fitting them from the top.

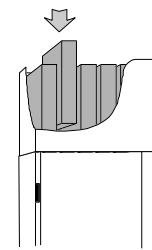

With these cartridges, despite a small additional pressure drop, it is possible to obtain a considerable noise reduction as shown below.

The maximum achievable noise reduction is -8.5 dB(A) at 2 m on the front part (and at 1.5 m from the floor) and -13 dB(A) at 1 m and at 45° from the unit top with a cartridge rank in a 1200-mm-high channel. The reduction values refer to the comparison with the noise values that can be measured for each unit with free drain. In the same conditions, with a supplementary cartridge rank, respectively -9.5 dB(A) and -14 dB(A) can be obtained.

Cartridge features

Unit	dimensions	free section	cartridge number	
			1 rows	2 rows
4	500 x 195 x 500	400 x 100	2	4
6	500 x 195 x 500	400 x 100	3	6
8	500 x 195 x 500	400 x 100	3	6
5	500 x 195 x 500	400 x 100	4	8
7	500 x 195 x 500	400 x 100	6	12
9	500 x 195 x 500	400 x 100	6	12

Damping in dB(A)

n. rows	Damping in dB(A) at different frequencies (Hz)							
	63	125	250	500	1000	2000	4000	8000
1	1	4	7	15	26	28	27	14
2	1	6	12	27	49	53	49	23

Pressure drop

n. rows	Pressure drop (Pa) for the different air flows (m^3/s)		
	0.2	0.4	0.6
1	1	4	9
2	3	11	26

11.12 – Delivery plenum with horizontal throw (models Over)

A delivery plenum with horizontal air ejection can be installed on the unit top. The plenum is made of the same materials and colours of the unit panels; the height is 300mm for models 4, 600 mm for models 6–8. A grid with a deflection rank can be installed on the drain opening, 0.35 m².

The plenum is lined with deadening material to reduce the sound emission through the delivery opening.

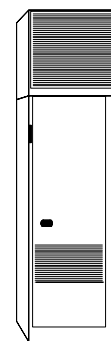

11.13 – Grid with one deflection rank (models Over)

A metal grid provided with adjustable deflection fins on one single rank to be installed on the unit top or on the plenum inlet can be supplied separately on request. In this way, the delivery air flow can be deflected toward the front or the rear part of the unit. Do not deflect the fins too much, as this may cause an excessive clogging of the air passage section with consequent unacceptable reduction of the unit refrigerating output.

11.14 – Base–frames: models TBD

When required, a base–frame that can be adjusted in height by ± 25 mm can be supplied starting from 200 mm to support Hiflex machines (see enclosed drawings).

Model	Length [mm]	Depth [mm]	Height [mm]
4	740	445	> 300
6	740	595	
8	740	745	
5	1470	445	> 500
7	1470	595	> 800
9	1470	745	

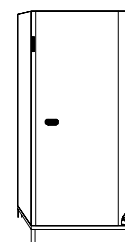

11.15 – Base–modules (models Over)

A suitable 200 mm (300 mm with high efficiency filters and 500 mm with suction from rear) –high base–module can be supplied on request to support the Hiflex Over units; it is open on the rear side to allow return air from the bottom even if there is no raised floor (the unit must be provided with a blind front panel – see return air from the bottom in the section Special features).

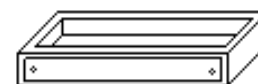

11.16 – Automatic condensate drain pump

Hiflex drain piping can be connected to a pump complete with a flow switch for automatic start and stop.

Features of the automatic condensate drain pump

water flow	[l/s]	0.083	0.167	0.250	0.333
available head	[kPa]	20	19	18	14
dimensions	[mm]	95	95	95	95

11.17 – Non–return valve (models A and D)

For air–condensed units, a non–return valve is supplied on request in a separate kit. It should be installed on the liquid line near the condenser, vertically with downward flow. The installation of this valve is absolutely necessary when the total charge of the system exceeds the values given in the table:

Model	Maximum refrigerant charge without non–return valve [kg]
4S/P/M	4.5
4L/G	2
6S/P	2
6L/G	4.5
8S/P	4.5
8L/G	4.5
5S/P/M	4.5 x 2
5L/G	2 x 2
7S/P	2 x 2
7L/G	4.5 x 2
9S/P	4.5 x 2
9L/G	4.5 x 2

11.18 – Additional temperature and humidity sensor (EEAP)

“EEAP” is an additional temperature and relative humidity sensor similar to the humitemp sensor. EEAP means “Electronic Environmental Alarm Package”.

The sensor can be installed in a representative place up to 20 m from the conditioner and emits an alarm if the temperature or the relative humidity exceeds one of the four thresholds that can be selected by the user:

high temperature	(from 10 °C to 50 °C)
low temperature	(from 0 °C to 30 °C)
high relative humidity	(from 30% to 99%)
low relative humidity	(from 10% to 70%).

11.19 – Microprocessor control with graphic display HIROMATIC G

The Hiromatic graphic display terminal is particularly suitable for group management. Indeed, thanks to the generous dimensions of the display and to its exceptional contrast, it allows the user to move around freely within the Microface network. Therefore, from a single point, it is possible to control the whole system without moving from one unit to another. The last 200 events occurring in the system; the graphic development of the last 24 hours for each of the units connected (stored since the last start–up), the user’s menus available in 8 languages and connectivity through RS 422 to the Hirolink Communication Manager are just some of the features available with Hiromatic. Moreover, as Hiromatic can be supplied in kit form, it may be installed either on the unit or on a remote panel for primary supervision of the system.

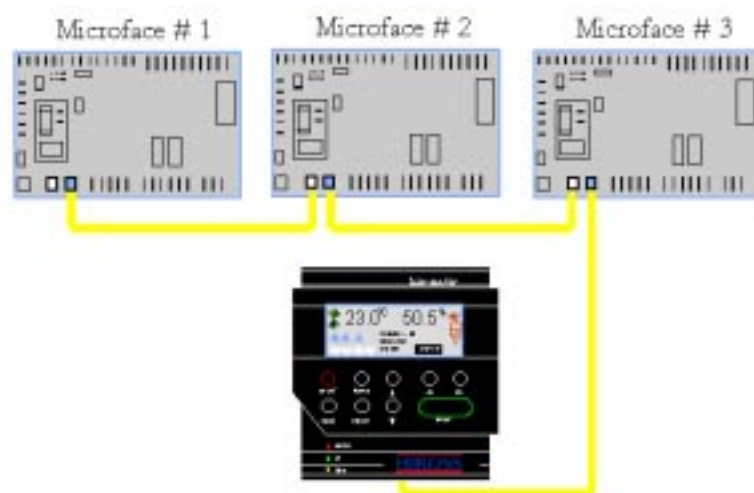

Hiromatic controls the date and time functions using them as operating information for the customer and as a reference whenever a status change occurs, causing the storage in the Report status. In addition, details of the event which occurred and the date and time at which the event occurred are stored as well. Thanks to the buffered RAM it is possible to store the operating hours of each component (compressor, fan, electric heaters, humidifier) of the various interconnected units.

In addition to the date–time function, there is a function for stand–by unit rotation which can be activated *only by means of Hiromatic* at a preset time of day. This is different from the Microface function, in which the rotation occurs when 24 operating hours of one unit have been reached.

Finally, Hiromatic allows the Microface units to be integrated with Hirolink; for this purpose it is necessary to install a RS422 card at the back of Hiromatic. In this way, Hiromatic can control up to 8 Microface units and communicate the relevant data to Hirolink.

Serial communication

Integration

Hirolink is the key to the integration; it works as 'communication manager' between the Hiromatic–Microface units and all the foremost supervision systems available on the market. It also provides the link with Hirovisor supervision system, which is the ideal solution for all integration requirements within the intelligent building. This permits local access to the units or, as an alternative, modem connection to supervise several installations from a single remote point.



The components necessary for integration are shown in the picture above. The only 'variations' are the software installed on Hirolink and the relevant hardware configuration which determines a different code.

11.20 – Deadening insulation coating

On request, a fiber glass insulation may be provided as heat and sound protection: a protective film and a special gasket on the closing prevent particle dispersion and help the proper mechanical resistance of the insulation. Some plastic gaskets fit on the panel hinder the air by–pass. The material is fully nonflammable and meets the requirements of the American norms NFPA90A and 90B concerning fire and smoke prevention.

11.21 – Duct with deadening insulation coating

A special duct with nonflammable deadening insulation coating in compliance with the fire and smoke prevention norms NFPA and 90B can be supplied on request.

11.22 – Power supply at 230/3/50

On request, all machines can be adapted for the power supply at 230/3/50.
 The refrigerating powers of the version at 230/3/50 are the same as the standard version at 400/3/50.
 The electric configurations are shown in the section "Summary of the electrical features".

11.23 – Special packing

A special packing for sea transport consisting of a wooden box or crate in addition to normal cardboard can be supplied on request.

11.24 – Air intake from the bottom (models Over)

Hiflex units can be supplied to enable the air intake. In this case, the front panel with intake grille is replaced by a special blind panel, which allows the sound emission to be further limited.

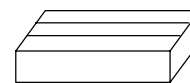

11.25 – Accessory combination

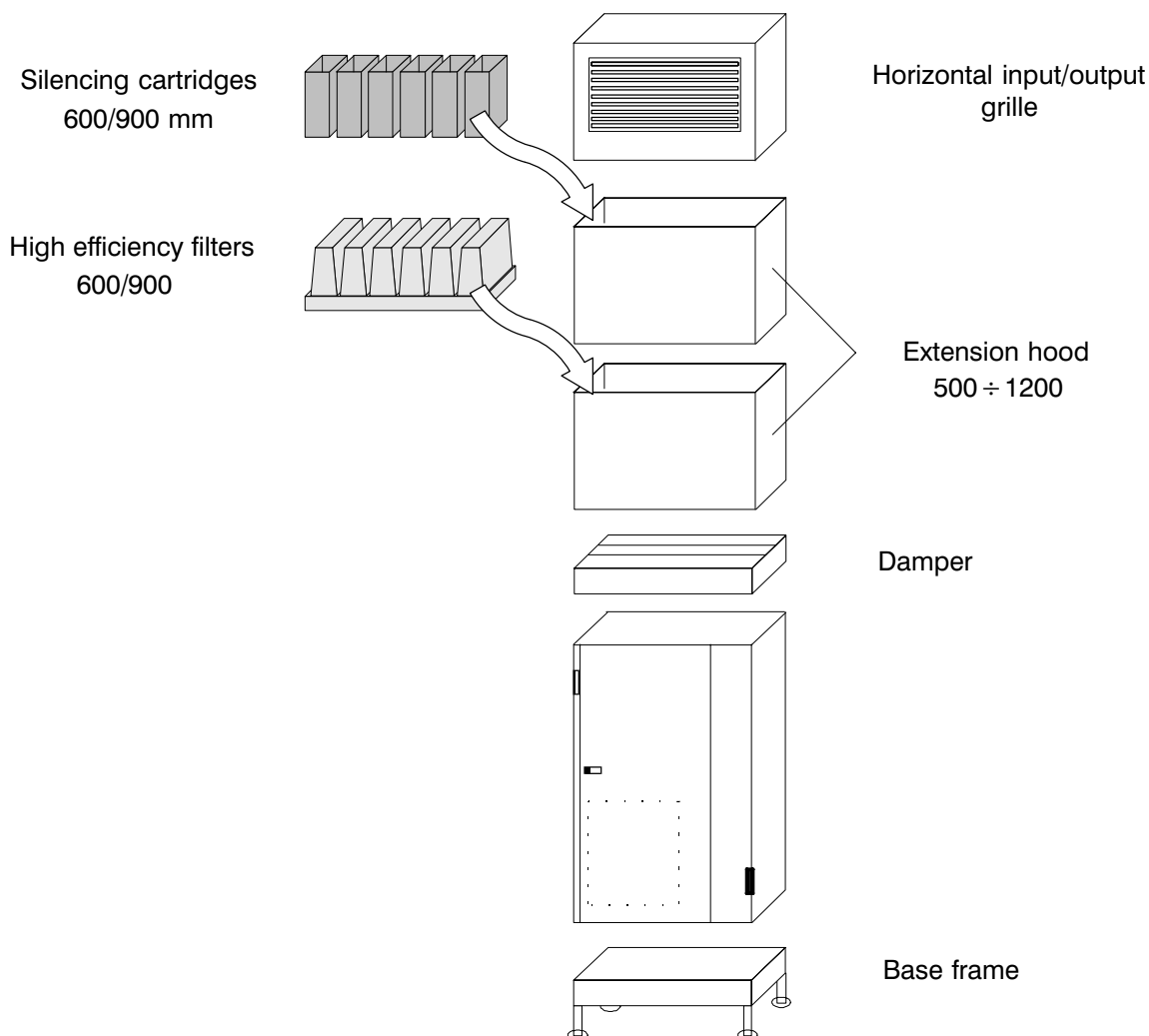

12 – Overall dimensions

Under

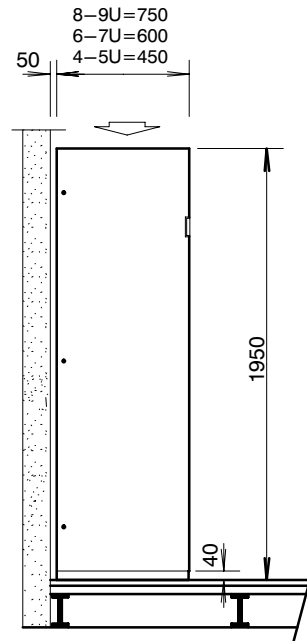
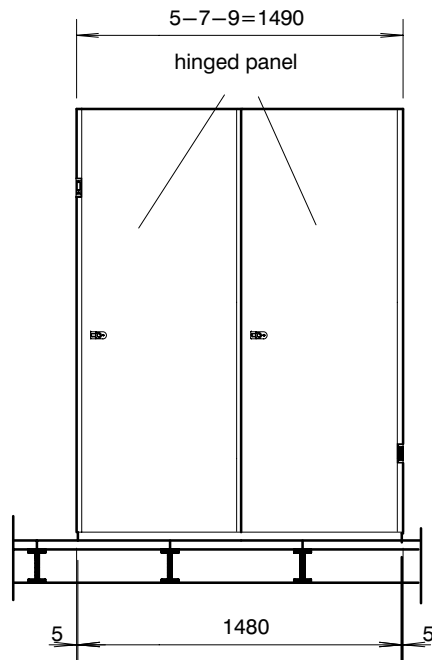
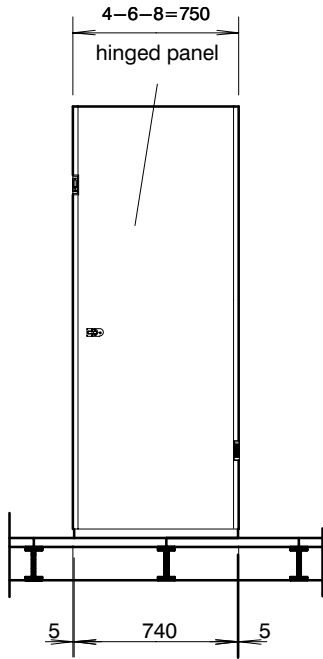

Over

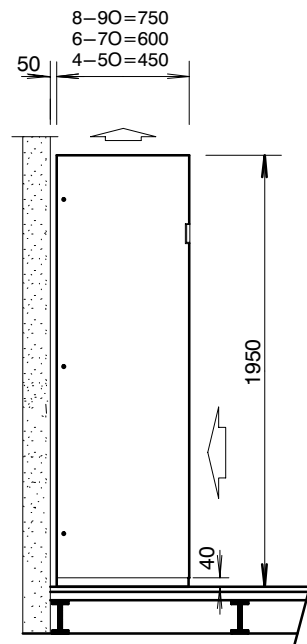
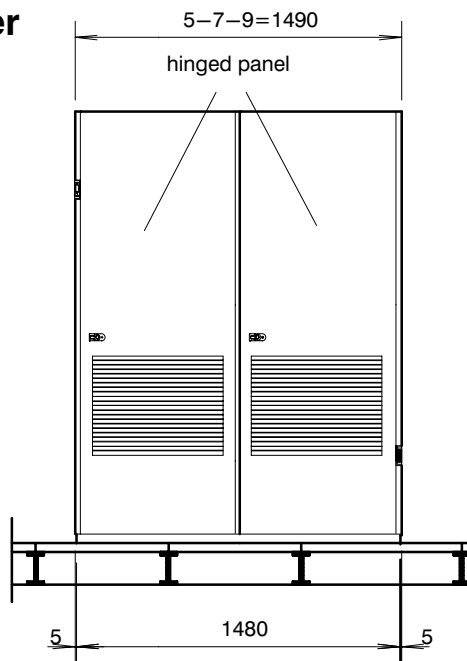
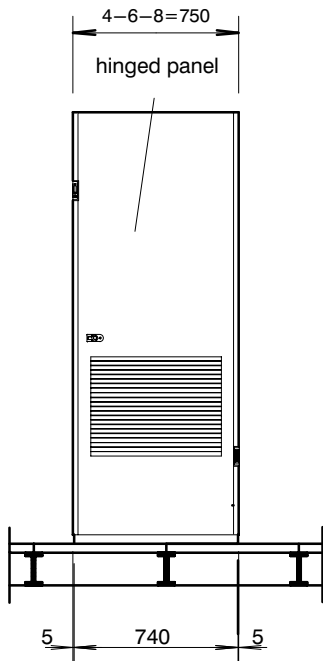

Il Fabbricante dichiara che questo prodotto è conforme alle direttive Europee:

The Manufacturer hereby declares that this product conforms to the European Union directives:

Der Hersteller erklärt hiermit, dass dieses Produkt den Anforderungen der Europäischen Richtlinien gerecht wird:

Le Fabricant déclare que ce produit est conforme aux directives Européennes:

El Fabricante declara que este producto es conforme a las directivas Europeas:

O Fabricante declara que este produto está em conformidade com as directivas Europeias:

Tillverkare försäkrar härmed att denna produkt överensstämmer med Europeiska Unionens direktiv:

De Fabrikant verklaart dat dit produkt conform de Europese richtlijnen is:

Vaimistaja vakuuttaa täten, että tämä tuote täyttää seuraavien EU-direktiivien vaatimukset:

Produsent erklærer herved at dette produktet er i samsvar med EU-direktiver:

Fabrikant erklærer herved, at dette produkt opfylder kravene i EU direktiverne:

Ο Κατασκευαστής δηλώνει ότι το παρόν προϊόν είναι κατασκευασμένο σύμφωνα με τις οδηγίες της Ε.Ε.:

98/37/CE; 89/336/CEE; 73/23/CEE; 97/23/EC

Liebert
HIROSS



Zona Industriale Tognana
Via Leonardo da Vinci, 8
35028 Piove di Sacco (PD)
ITALY

Tel. +39 049 9719111
Telefax +39 049 5841257
Internet : www.hiross.it/pde

Since the Liebert HIROSS Company has a policy of continuous product improvement, it reserves the right to change design and specifications without previous notice.



Liebert HIROSS
is a division of
EMERSON