

Industrial air cooler DVS

Cooling and working rooms

Cu/Al - R404A

GEA Heat Exchangers



Goedhart



Goedhart DVS

The Goedhart DVS range of dual discharge ceiling mounted air coolers consists of 162 types with capacities between 3,1 and 151.7 kW. The aircoolers are especially suitable for cooling and working room applications. The height of the aircooler is low, so the maximum space in the chill room can be utilised. The coil block is standard build from aluminium end plates, copper tubes and aluminium fins. The fans are arranged for blow-through or draw-through air configuration (please state which is required when ordering). The modular design incorporates 5 different sizes of fan, with model options of up to 6 fans per cooler.

Type description

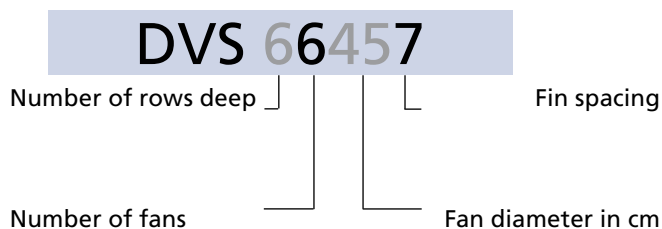

Coil execution

- Tube pitch : 50x50 mm straight
- Fin spacings : 4, 7, 10 mm
- Material : 15 mm o.d. copper tubes
- : aluminium HT-fins
- Goedhart DVS coil blocks have copper tubes mechanically expanded into fully collared aluminium fins, providing excellent thermal contact. All evaporator coils are pressure tested to 30 bars (lower by coolants) and supplied with a light overpressure charge.
- The coolers are suitable for the most commonly used refrigerants/coolants with the exception of NH3.

Casing

- Construction for ceiling mounting
- Casing material of galvanized sheet steel
- Finishing is standard white epoxy spray (RAL 9003)
- Bend/header protection by end covers, easy removed for maintenance
- 2 Hinged drip trays underneath each coil block.
- Defrost by hot gas spiral or electric defrost elements will be fixed to the bottom side of the coil.

General range features

Capacity

The listed nominal cooling capacities are based on R404A, DT1 and DTM and a RH of 85%.

Influence of coating on capacity

The use of coated fins, or of a fully coated coil will result in a capacity decrease of approximately 3%

Capacity optimisation

Since Goedhart tries to limit stock products, we are capable of optimising the circuitry of our evaporators. In order to do this, the following information is needed :

- Design capacity
- Air volume
- Refrigerant
- Air on temperature
- Evaporating temperature
- Liquid temperature before expansion valve.

Sound data

The mean sound pressure (LpA @ 3m ± 2 dB (A)) each air cooler is a calculated indication value according to the EN13487 standard parallel pipe. Goedhart uses the fan manufacturer's sound power level (LwA) at the inlet side of the fan. Changes to or by the fan or the product, affect the sound, in these cases, consult the manufacturer for the new indication value. In critical sound requirements, we advise you to consult an expert.

Defrost systems

For room temperatures where ice-build up can be expected and where the coil can not be defrosted by the room air, electric or hot gas defrost is necessary

Electrical defrost

On request Goedhart DVS can be provided with electrical defrost. The stainless steel heating elements are fitted in the coil block within aluminium tubes, which forms a highly conductive medium between the heaters and the fins. In the drip tray heater elements are fitted to the underside of the aluminium inner tray. The elements are rated for 220/240 V and are connected (IP55) for 380/415 V (with neutral) supply. The heater elements in the coil block are removable from the bend side, whilst the tray heater elements can be removed once the outer tray has been removed.

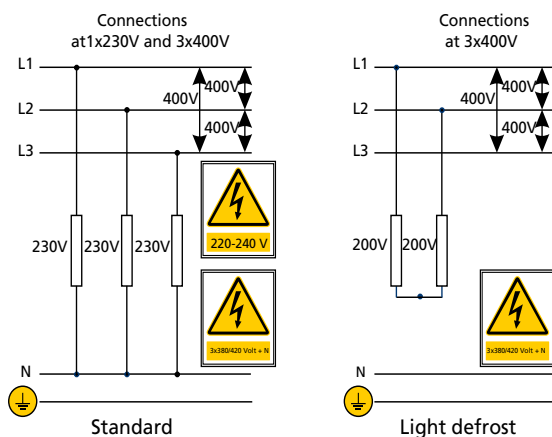

Hot gas defrost

The coil block is suited for hot gas defrost (hot gas supply through the suction header). The drip tray can be provided with a copper hot gas spiral. This is enclosed in aluminium profiles that are rigidly secured to the under side of the aluminium inner drip tray

Accessories:

Standard accessories for the Goedhart DVS aircoolers are:

- electric, hotgas defrost system.
- insulation in the space between the inner and outer drip tray.
- insulated hygienic polyester drip tray.
- insulated fanplate
- hinged fan plate
- single phase motors

The accessories are included in the price list.

Optional extras:

Various optional extras for the Goedhart DVS are available, price and delivery upon request:

- insulation discs
- 60 Hz motors
- water defrost system
- glycol/water/etc. cooling mediums
- stainless steel casing
- other fin spacings
- other fans (when external pressure is requested)

Mounting and Maintenance

Goedhart DVS is delivered on a wooden frame. When on the frame, Goedhart DVS can be handled by forklift truck, which makes positioning and installation simple. Refer to our maintenance and installation manual.

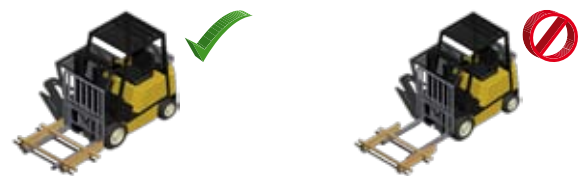

Fans

The manufacturer of the fans is Süd Electric (we reserve the right to alter the manufacturer). The fans have glass fibre reinforced polypropylene impellers. The motors are available for 400V-50Hz-3 phase or 230V-50Hz-1 phase electrical supply. 2-Speed regulation can be achieved at 400/690V-50Hz-3 phase by using a D-Y reconnection (fig. 1). 3 Phase motors are suitable for a frequency controller (A sinus filter is needed, fig. 2). 1 Phase motors are suitable for phase control and transformer. The motors are standard executed with a thermo contact. The fans are suitable for operation in air temperature applications between -40 oC and +45 oC. When the air temperature is lower then -40 °C , special fans are needed. These speciale fans have a longer delivery time. The technical data in the table below are the same as on the motor name plates and is valid for an air temperature of +40 °C.

For air temperatures lower then +40 oC, the current amperage can be calculated by using the diagram multiplication factor, suitable thermal overloads can then be selected.

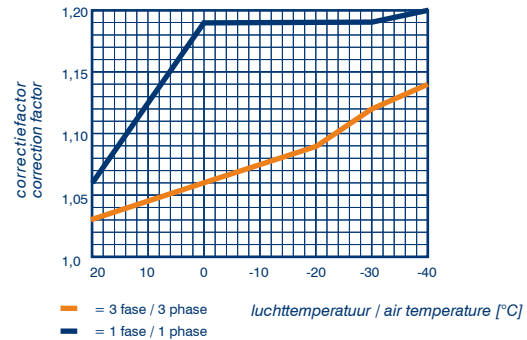

Three phase - 50 Hz

| Fan type | Δ | | | | | Y | | | Protection class* | Fan heating |
|----------|---------|-------------------|-------|-----|---|-------------------|-------|-----|-------------------|-------------|
| | Tension | Speed | Input | FLC | Sound power indication each fan LwA (+/-2dB(A)) | Speed | Input | FLC | | |
| | V | min ⁻¹ | Watt | A | dB(A) | min ⁻¹ | Watt | A | | |

4 pole motor (n=1500 rpm nom.)

| | | | | | | | | | | |
|------------|-----------|------|------|------|----|------|------|------|------|-----|
| 400-32° | 3x400/690 | 1350 | 250 | 0.60 | 74 | 1050 | 150 | 0.30 | IP44 | 460 |
| 450-32° | 3x400/690 | 1350 | 400 | 0.85 | 78 | 1050 | 300 | 0.50 | IP44 | 580 |
| 500-40° | 3x400/690 | 1380 | 880 | 1.90 | 85 | 1050 | 660 | 1.15 | IP44 | 580 |
| 560-36° | 3x400/690 | 1300 | 1250 | 2.30 | 85 | 1000 | 750 | 1.30 | IP66 | 700 |
| 630-32°*** | 3x400/690 | 1300 | 1250 | 2.30 | 86 | 1000 | 750 | 1.30 | IP66 | 820 |
| 630-28°*** | 3x230/400 | | | | 88 | 1400 | 1400 | 2.50 | IP66 | 820 |

6 pole motor (n=1000 rpm nom.)

| | | | | | | | | | | |
|---------|-----------|-----|-----|------|----|-----|-----|------|------|-----|
| 400-28° | 3x400/690 | 900 | 105 | 0.33 | 63 | 750 | 65 | 0.13 | IP44 | 460 |
| 450-32° | 3x400/690 | 900 | 180 | 0.40 | 69 | 750 | 120 | 0.20 | IP44 | 580 |
| 500-40° | 3x400/690 | 900 | 500 | 1.00 | 81 | 760 | 350 | 0.65 | IP44 | 580 |
| 560-32° | 3x400/690 | 880 | 680 | 1.60 | 75 | 680 | 400 | 0.90 | IP66 | 700 |
| 630-36° | 3x400/690 | 880 | 680 | 1.60 | 80 | 680 | 400 | 0.90 | IP66 | 820 |

Single phase - 50 Hz

| Ventilator type | Speed | Input | FLC | Protection class* |
|-----------------|-------------------|-------|-----|-------------------|
| | min ⁻¹ | Watt | A | |

4 pole motor (n=1500 rpm nom.)

| | | | | |
|---------|------|------|------|------|
| 400-32° | 1350 | 450 | 1.95 | IP44 |
| 450-32° | 1350 | 450 | 1.95 | IP44 |
| 500-40° | 1330 | 700 | 3.40 | IP44 |
| 560-36° | 1350 | 920 | 4.00 | IP66 |
| 630-32° | 1350 | 1300 | 7.10 | IP66 |

6 pole motor (n=1000 rpm nom.)

| | | | | |
|---------|-----|-----|------|------|
| 400-28° | 900 | 250 | 1.10 | IP44 |
| 450-32° | 900 | 250 | 1.10 | IP44 |
| 500-40° | 900 | 400 | 1.75 | IP44 |
| 560-32° | 870 | 700 | 3.40 | IP66 |
| 630-36° | 870 | 700 | 3.40 | IP66 |

*= IP44 motors also available in IP66 execution (extra price)

**= Only cooling conditions

***= Only freezing conditions

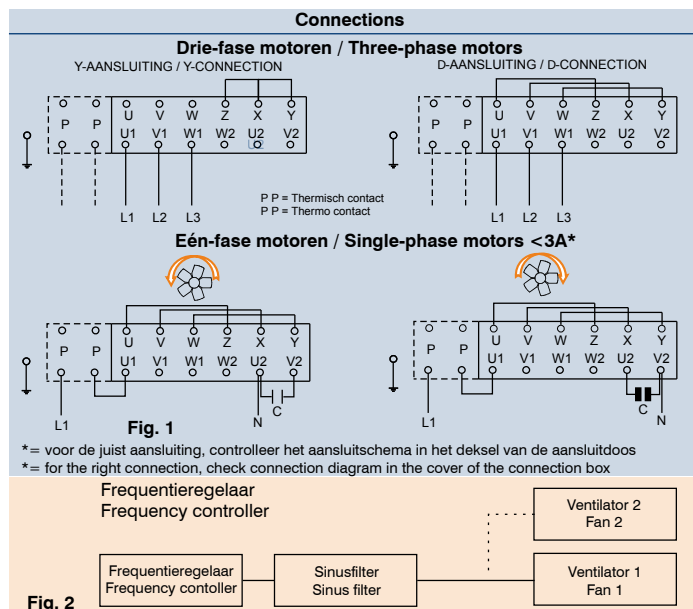

Correction factors

Capacities at DTM:

The capacities are based on R404A direct expansion and the difference between the mean air temperature and the evaporation temperature (DTM). The evaporation temperature is the saturated temperature corresponding to the pressure at the suction outlet of the cooler. The nominal capacities are based on evaporation temperatures of -5 °C, a DTM of 7 K and light frosting. Capacities for other mediums and systems are available upon request.

Correction factors for various mean air temperatures and evaporation temperatures (DTM) are as indicated in the tables below. The requested capacity must be multiplied by a correction factor from one of these tables.

$$Q_{\text{nominal}} = \text{factor} \times Q_{\text{requested}}$$

Capacities at DT1:

Hereby the capacities are based on R404A direct expansion and DT1. DT1 is the difference between air-on temperature and the evaporation temperature of the cooler. The evaporation temperature is the saturated temperature corresponding to the pressure at the suction outlet of the cooler. The nominal capacities are based on evaporation temperatures of -8°C and DT1=8K and light frosting. Capacities for other mediums and systems are available upon request.

Correction factors for various air-on temperatures and temperature differences (DT1) are as indicated in the table below. The requested capacity must be multiplied by a correction factor from the table, so that a cooler with the resulting nominal capacity can be chosen from the selection tables.

$$Q_{\text{nominal}} = \text{factor} \times Q_{\text{requested}}$$

R404A light frost = 0.2 mm RH = 85%

| DTM K | Evaporation temperature (°C) | | | | | | |
|----------|------------------------------|------|------|------|------|-------|------|
| | 0 | -2,5 | -5 | -7,5 | -10 | -12,5 | -15 |
| 6 | 1.20 | 1.23 | 1.26 | 1.28 | 1.31 | 1.32 | 1.33 |
| 7 | 0.96 | 0.98 | 1.00 | 1.03 | 1.04 | 1.07 | 1.08 |
| 8 | 0.79 | 0.82 | 0.84 | 0.85 | 0.87 | 0.88 | 0.88 |
| 9 | 0.68 | 0.70 | 0.71 | 0.72 | 0.75 | 0.77 | 0.77 |
| 10 | 0.58 | 0.59 | 0.62 | 0.64 | | | |

Prices on request due to divergent circuits

| DT1 K | Evaporation temperature (°C) | | | | | | |
|----------|------------------------------|------|------|------|------|-------|------|
| | 0 | -2,5 | -5 | -7,5 | -10 | -12,5 | -15 |
| 6 | 1.40 | 1.43 | 1.45 | 1.48 | 1.51 | 1.54 | 1.56 |
| 7 | 1.12 | 1.15 | 1.18 | 1.20 | 1.22 | 1.24 | 1.25 |
| 8 | 0.93 | 0.95 | 0.97 | 1.00 | 1.01 | 1.03 | 1.05 |
| 9 | 0.78 | 0.81 | 0.83 | 0.85 | 0.87 | 0.88 | 0.89 |
| 10 | 0.68 | 0.70 | 0.72 | 0.74 | 0.75 | 0.76 | 0.78 |
| 11 | 0.60 | 0.62 | 0.63 | 0.65 | | | |

Prices on request due to divergent circuits

 = calculated without frosting

 = calculated without frosting

R404A normal frost = 0.5 mm RH= 85%

| DTM K | Evaporation temperature (°C) | | | | | | |
|----------|------------------------------|------|------|------|------|-------|------|
| | 0 | -2,5 | -5 | -7,5 | -10 | -12,5 | -15 |
| 6 | | 1.37 | 1.41 | 1.43 | 1.46 | 1.47 | 1.49 |
| 7 | | 1.10 | 1.13 | 1.15 | 1.17 | 1.19 | 1.20 |
| 8 | | 0.92 | 0.94 | 0.96 | 0.98 | 0.99 | 1.00 |
| 9 | | | 0.80 | 0.82 | 0.83 | 0.84 | 0.88 |
| 10 | | | 0.69 | 0.71 | 0.74 | 0.74 | 0.75 |
| 11 | | | 0.62 | 0.63 | 0.64 | | |

Prices on request due to divergent circuits

| DT1 K | Evaporation temperature (°C) | | | | | | |
|----------|------------------------------|------|------|------|------|-------|------|
| | 0 | -2,5 | -5 | -7,5 | -10 | -12,5 | -15 |
| 6 | | 1.57 | 1.59 | 1.62 | 1.64 | 1.67 | 1.69 |
| 7 | | 1.26 | 1.28 | 1.31 | 1.33 | 1.35 | 1.37 |
| 8 | | 1.05 | 1.07 | 1.09 | 1.11 | 1.13 | 1.14 |
| 9 | | | 0.91 | 0.93 | 0.95 | 0.96 | 0.97 |
| 10 | | | 0.79 | 0.81 | 0.82 | 0.84 | 0.85 |
| 11 | | | 0.70 | 0.71 | 0.82 | 0.74 | 0.75 |
| 12 | | | 0.62 | 0.64 | 0.65 | | |

Prices on request due to divergent circuits

ATTENTION !!!

When making your selection, pay attention to the ratio between the airvolume and capacity. A low volume to capacity ratio results in a wide temperature drop across the coil which cause to dry out (especially on coils with a high number of rows deep).

The correction factors on this page have been calculated using a varying SHR (ratio of sensible heat load / total heat load). The chart left indicates the SHR values used in the calculations, in which dt is the difference between the air and evaporation temperatures. The SHR values have been based on entering air with a relative humidity of 85%.

Example:

- $t_o = -10$ °C and dt = 10 K resultant SHR value is 0.70
- $t_o = -10$ °C and dt = 5 K resultant SHR value is 0.82
- $t_o = -30$ °C and dt = 10 K resultant SHR value is 0.84
- $t_o = -30$ °C and dt = 5 K resultant SHR value is 0.98

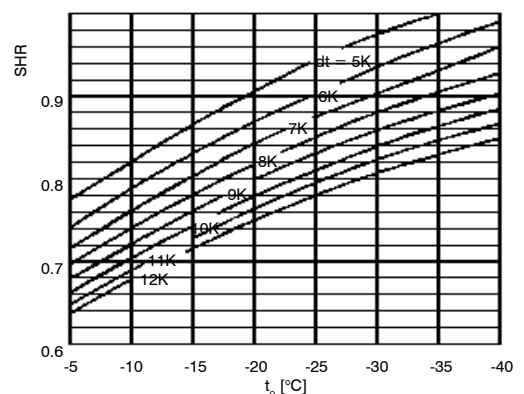

DVS 4mm Technical data

| Type DVS | 3x400V-50H-4pole (1500 min ⁻¹ nom.) | | | | 3x400V-50H-6pole (1000 min ⁻¹ nom.) | | | | Surface m ² | Internally volume dm ³ | Weight kg | Dimensions | | | | | | | Connections | | | |
|-------------|---|--------------------------------|---------------------------------|-----------------------------|---|--------------------------------|---------------------------------|-----------------------------|---------------------------|--------------------------------------|--------------|------------|----|----|----|----|----|----|-------------|-----|---------|-------|
| | R404A | | Air volume m ³ /h | LpA @ 3 m (+/-2 dB(A))** | R404A | | Air volume m ³ /h | LpA @ 3 m (+/-2 dB(A))** | | | | L | B | H | E1 | E2 | E3 | E4 | Refrigerant | | | Drain |
| | DTM = 7K Air mean = +2°C | DT1 = 8K (SC2) Air on = 0°C | | | DTM = 7K Air mean = +2°C | DT1 = 8K (SC2) Air on = 0°C | | | | | | | | | | | | | in | out | Hot gas | |
| | kW | kW | kW | kW | kW | kW | mm | mm | | | | mm | mm | mm | mm | mm | mm | mm | mm | mm | mm | NW" |

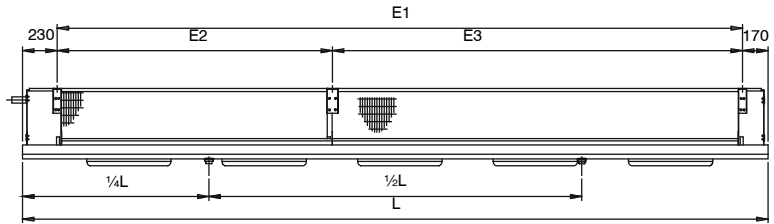
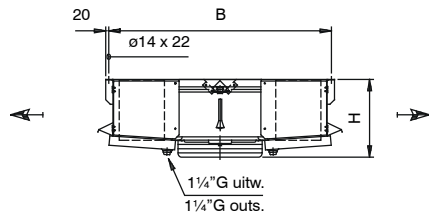

| | | | | | | | | | | | | | | | | | | |
|----------|------|------|-------|----|------|------|----|-----|----|-----|------|------|-----|------|----|----|------|----------|
| 4.1.40.4 | 5,6 | 4,9 | 3082 | 52 | 5,1 | 1892 | 41 | 39 | 6 | 100 | 1056 | 1180 | 420 | 656 | 15 | 15 | 4x19 | 2x1 1/4" |
| 6.1.40.4 | 9,2 | 6,6 | 2837 | 52 | 7,6 | 1790 | 41 | 58 | 10 | 120 | 1056 | 1380 | 420 | 656 | 22 | 12 | 4x19 | 2x1 1/4" |
| 4.1.45.4 | 9,2 | 7,8 | 4610 | 56 | 7,8 | 2901 | 47 | 52 | 8 | 114 | 1056 | 1230 | 520 | 656 | 22 | 12 | 4x19 | 2x1 1/4" |
| 6.1.45.4 | 12,9 | 9,3 | 4239 | 56 | 10,4 | 2632 | 47 | 78 | 12 | 140 | 1056 | 1430 | 520 | 656 | 22 | 12 | 4x19 | 2x1 1/4" |
| 4.1.50.4 | 11,6 | 10,2 | 6946 | 63 | 10,6 | 4599 | 59 | 78 | 12 | 147 | 1356 | 1280 | 520 | 956 | 22 | 12 | 4x19 | 2x1 1/4" |
| 6.1.50.4 | 19,2 | 14,5 | 6527 | 63 | 16,5 | 4315 | 59 | 117 | 18 | 182 | 1356 | 1480 | 520 | 956 | 28 | 16 | 4x19 | 2x1 1/4" |
| 4.1.56.4 | 19,2 | 16,4 | 9904 | 63 | 16,7 | 6294 | 53 | 108 | 16 | 182 | 1456 | 1340 | 620 | 1056 | 28 | 16 | 4x19 | 2x1 1/4" |
| 6.1.56.4 | 27,3 | 20,3 | 9381 | 63 | 22,7 | 5942 | 53 | 162 | 24 | 226 | 1456 | 1540 | 620 | 1056 | 35 | 16 | 4x19 | 2x1 1/4" |
| 4.1.63.4 | 22,1 | 19,0 | 12071 | 63 | 20,3 | 8820 | 58 | 130 | 20 | 203 | 1456 | 1410 | 720 | 1056 | 35 | 16 | 4x19 | 2x1 1/4" |
| 6.1.63.4 | 32,6 | 24,4 | 11387 | 63 | 28,2 | 8283 | 58 | 195 | 30 | 254 | 1456 | 1610 | 720 | 1056 | 35 | 16 | 4x19 | 2x1 1/4" |

| | | | | | | | | | | | | | | | | | | |
|----------|------|------|-------|----|------|-------|----|-----|----|-----|------|------|-----|------|----|----|------|----------|
| 4.2.40.4 | 13,2 | 10,9 | 6152 | 55 | 11,0 | 3779 | 44 | 77 | 12 | 154 | 1656 | 1180 | 420 | 1256 | 22 | 12 | 4x19 | 2x1 1/4" |
| 6.2.40.4 | 18,3 | 13,2 | 5660 | 55 | 15,1 | 3574 | 44 | 116 | 18 | 191 | 1656 | 1380 | 420 | 1256 | 28 | 12 | 4x19 | 2x1 1/4" |
| 4.2.45.4 | 18,3 | 15,5 | 9206 | 59 | 15,6 | 5791 | 50 | 103 | 16 | 178 | 1656 | 1230 | 520 | 1256 | 28 | 16 | 4x19 | 2x1 1/4" |
| 6.2.45.4 | 25,6 | 18,5 | 8458 | 59 | 20,6 | 5250 | 50 | 155 | 24 | 222 | 1656 | 1430 | 520 | 1256 | 35 | 16 | 4x19 | 2x1 1/4" |
| 4.2.50.4 | 24,7 | 21,4 | 13882 | 66 | 22,4 | 9191 | 62 | 155 | 24 | 246 | 2256 | 1280 | 520 | 1856 | 35 | 16 | 4x19 | 2x1 1/4" |
| 6.2.50.4 | 39,4 | 28,8 | 13039 | 66 | 33,1 | 8621 | 62 | 233 | 34 | 306 | 2256 | 1480 | 520 | 1856 | 35 | 16 | 4x19 | 2x1 1/4" |
| 4.2.56.4 | 39,7 | 33,2 | 19794 | 66 | 33,7 | 12580 | 56 | 216 | 32 | 304 | 2456 | 1340 | 620 | 2056 | 42 | 16 | 4x19 | 2x1 1/4" |
| 6.2.56.4 | 55,8 | 40,9 | 18745 | 66 | 45,7 | 11873 | 55 | 324 | 48 | 386 | 2456 | 1540 | 620 | 2056 | 42 | 22 | 4x19 | 2x1 1/4" |
| 4.2.63.4 | 46,3 | 39,4 | 24125 | 66 | 42,4 | 17627 | 60 | 259 | 38 | 341 | 2456 | 1410 | 720 | 2056 | 42 | 16 | 4x19 | 2x1 1/4" |
| 6.2.63.4 | 65,5 | 49,4 | 22752 | 66 | 58,3 | 16550 | 60 | 388 | 58 | 436 | 2456 | 1610 | 720 | 2056 | 42 | 22 | 4x19 | 2x1 1/4" |

| | | | | | | | | | | | | | | | | | | |
|----------|------|------|-------|----|------|-------|----|-----|----|-----|------|------|-----|------|----|----|------|----------|
| 4.3.45.4 | 24,7 | 21,3 | 13799 | 61 | 22,1 | 8679 | 51 | 155 | 24 | 244 | 2256 | 1230 | 520 | 1856 | 35 | 16 | 4x19 | 2x1 1/4" |
| 6.3.45.4 | 39,0 | 28,4 | 12678 | 61 | 31,7 | 7868 | 51 | 233 | 34 | 304 | 2256 | 1430 | 520 | 1856 | 35 | 16 | 4x19 | 2x1 1/4" |
| 4.3.50.4 | 42,9 | 35,7 | 20816 | 67 | 37,3 | 13783 | 63 | 233 | 34 | 344 | 3156 | 1280 | 520 | 2756 | 42 | 16 | 4x19 | 2x1 1/4" |
| 6.3.50.4 | 60,0 | 43,6 | 19551 | 67 | 50,3 | 12926 | 63 | 349 | 52 | 435 | 3156 | 1480 | 520 | 2756 | 42 | 22 | 4x19 | 2x1 1/4" |
| 4.3.56.4 | 58,7 | 49,6 | 29685 | 67 | 51,2 | 18864 | 57 | 323 | 48 | 430 | 3456 | 1340 | 620 | 3056 | 54 | 22 | 4x19 | 2x1 1/4" |
| 6.3.56.4 | 82,8 | 62,1 | 28111 | 67 | 69,4 | 17803 | 57 | 485 | 72 | 546 | 3456 | 1540 | 620 | 3056 | 54 | 22 | 4x19 | 2x1 1/4" |
| 4.3.63.4 | 70,9 | 59,9 | 36180 | 67 | 64,6 | 26433 | 62 | 388 | 58 | 481 | 3456 | 1410 | 720 | 3056 | 54 | 22 | 4x19 | 2x1 1/4" |
| 6.3.63.4 | 99,7 | 74,9 | 34117 | 67 | 88,7 | 24816 | 62 | 582 | 86 | 617 | 3456 | 1610 | 720 | 3056 | 54 | 22 | 4x19 | 2x1 1/4" |

Pay attention to the relation capacity / air volume !!

* Sound pressure indication (LpA) at 3 m distance each air cooler (+/- 2 dB(A)) , free field conditions, according EN13487

DVS 4mm Technical data

| Type DVS | 3x400V-50H-4pole (1500 min ⁻¹ nom.) | | | | 3x400V-50H-6pole (1000 min ⁻¹ nom.) | | | | Dimensions | | | | | | | | Connections | | | | | |
|-------------|---|--------------------------------|-------------------|------------------------------|---|--------------------------------|-------------------|------------------------------|----------------|-------------------|--------|----|----|----|----|----|-------------|----|-------------|-----|---------|-------|
| | R404A | | Air volume | LpA @ 3 m (+/- 2 dB(A))** | R404A | | Air volume | LpA @ 3 m (+/- 2 dB(A))** | Surface | Internally volume | Weight | L | B | H | E1 | E2 | E3 | E4 | Refrigerant | | | Drain |
| | DTM = 7K Air mean = +2°C | DT1 = 8K (SC2) Air on = 0°C | | | DTM = 7K Air mean = +2°C | DT1 = 8K (SC2) Air on = 0°C | | | | | | | | | | | | | in | out | Hot gas | |
| | kW | kW | m ³ /h | dB(A) | kW | kW | m ³ /h | dB(A) | m ² | dm ³ | kg | mm | mm | mm | mm | mm | mm | mm | mm | mm | mm | NW" |

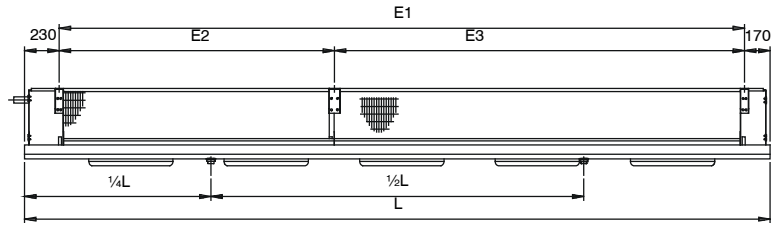
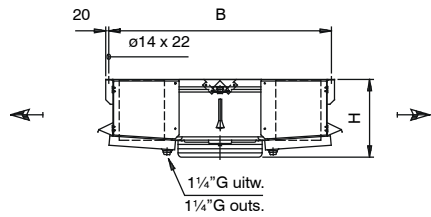

| | | | | | | | | | | | | | | | | | | | | | | |
|----------|-------|-------|-------|----|-------|-------|----|-----|-----|-----|------|------|-----|------|------|------|--|--|----|----|------|----------|
| 4.4.45.4 | 37,7 | 31,2 | 18394 | 62 | 31,5 | 11570 | 53 | 207 | 30 | 309 | 2856 | 1230 | 520 | 2456 | | | | | 42 | 16 | 4x19 | 2x1 1/4" |
| 6.4.45.4 | 52,1 | 36,9 | 16897 | 62 | 41,2 | 10486 | 53 | 310 | 46 | 391 | 2856 | 1430 | 520 | 2456 | | | | | 42 | 16 | 4x19 | 2x1 1/4" |
| 4.4.50.4 | 51,4 | 44,0 | 27751 | 68 | 46,3 | 18375 | 64 | 310 | 46 | 447 | 4056 | 1280 | 520 | 3656 | 1828 | 1828 | | | 42 | 16 | 4x19 | 2x1 1/4" |
| 6.4.50.4 | 80,7 | 58,4 | 26062 | 68 | 67,4 | 17231 | 64 | 466 | 68 | 564 | 4056 | 1480 | 520 | 3656 | 1828 | 1828 | | | 54 | 22 | 4x19 | 2x1 1/4" |
| 4.4.56.4 | 81,0 | 67,3 | 39575 | 68 | 68,4 | 25150 | 58 | 431 | 64 | 558 | 4456 | 1340 | 620 | 4056 | 2028 | 2028 | | | 54 | 22 | 4x19 | 2x1 1/4" |
| 6.4.56.4 | 113,7 | 83,2 | 37475 | 68 | 93,2 | 23734 | 58 | 647 | 94 | 713 | 4456 | 1540 | 620 | 4056 | 2028 | 2028 | | | 54 | 22 | 4x19 | 2x1 1/4" |
| 4.4.63.4 | 95,1 | 80,5 | 48235 | 68 | 86,8 | 35239 | 63 | 517 | 76 | 626 | 4456 | 1410 | 720 | 4056 | 2028 | 2028 | | | 54 | 22 | 4x19 | 2x1 1/4" |
| 6.4.63.4 | 134,1 | 100,5 | 45482 | 68 | 119,2 | 33082 | 63 | 776 | 114 | 806 | 4456 | 1610 | 720 | 4056 | 2028 | 2028 | | | 64 | 28 | 4x19 | 2x1 1/4" |

| | | | | | | | | | | | | | | | | | | | | | | |
|----------|-------|-------|-------|----|-------|-------|----|-----|-----|-----|------|------|-----|------|------|------|--|--|----|----|------|----------|
| 4.5.50.4 | 70,2 | 58,0 | 34685 | 69 | 59,0 | 22967 | 65 | 388 | 58 | 545 | 4956 | 1280 | 520 | 4556 | 1828 | 2728 | | | 54 | 22 | 4x19 | 4x1 1/4" |
| 6.5.50.4 | 97,7 | 72,1 | 32575 | 69 | 81,9 | 21536 | 65 | 582 | 86 | 690 | 4956 | 1480 | 520 | 4556 | 1828 | 2728 | | | 54 | 22 | 4x19 | 4x1 1/4" |
| 4.5.56.4 | 101,6 | 84,4 | 49466 | 69 | 85,7 | 31434 | 59 | 539 | 78 | 684 | 5456 | 1340 | 620 | 5056 | 2028 | 3028 | | | 54 | 22 | 4x19 | 4x1 1/4" |
| 6.5.56.4 | 142,6 | 103,9 | 46838 | 69 | 116,2 | 29665 | 58 | 808 | 118 | 874 | 5456 | 1540 | 620 | 5056 | 2028 | 3028 | | | 64 | 28 | 4x19 | 4x1 1/4" |
| 4.5.63.4 | 122,6 | 102,1 | 60290 | 69 | 109,3 | 44046 | 63 | 647 | 94 | 766 | 5456 | 1410 | 720 | 5056 | 2028 | 3028 | | | 64 | 28 | 4x19 | 4x1 1/4" |
| 6.5.63.4 | 171,9 | 123,7 | 56847 | 69 | 149,1 | 41348 | 63 | 970 | 142 | 987 | 5456 | 1610 | 720 | 5056 | 2028 | 3028 | | | 64 | 28 | 4x19 | 4x1 1/4" |

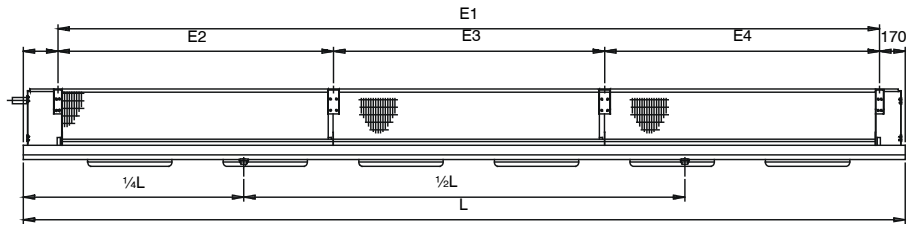
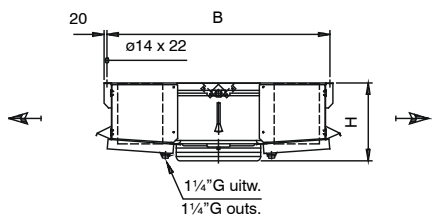

| | | | | | | | | | | | | | | | | | | | | | | | |
|----------|-------|-------|-------|----|-------|-------|----|------|-----|------|------|------|-----|------|------|------|------|--|--|----|----|------|----------|
| 4.6.50.4 | 87,3 | 72,3 | 41620 | 69 | 75,6 | 27558 | 65 | 465 | 68 | 643 | 5856 | 1280 | 520 | 5456 | 1828 | 1800 | 1828 | | | 54 | 22 | 4x19 | 4x1 1/4" |
| 6.6.50.4 | 122,0 | 88,0 | 39087 | 69 | 101,8 | 25842 | 65 | 698 | 102 | 817 | 5856 | 1480 | 520 | 5456 | 1828 | 1800 | 1828 | | | 54 | 28 | 4x19 | 4x1 1/4" |
| 4.6.56.4 | 119,5 | 100,6 | 59356 | 69 | 103,9 | 37720 | 59 | 646 | 94 | 811 | 6456 | 1340 | 620 | 6056 | 2028 | 2000 | 2028 | | | 64 | 22 | 4x19 | 4x1 1/4" |
| 6.6.56.4 | 168,5 | 125,5 | 56202 | 69 | 140,8 | 35594 | 59 | 970 | 142 | 1039 | 6456 | 1540 | 620 | 6056 | 2028 | 2000 | 2028 | | | 64 | 28 | 4x19 | 4x1 1/4" |
| 4.6.63.4 | 144,0 | 121,6 | 72343 | 70 | 130,9 | 52853 | 64 | 776 | 114 | 910 | 6456 | 1410 | 720 | 6056 | 2028 | 2000 | 2028 | | | 64 | 28 | 4x19 | 4x1 1/4" |
| 6.6.63.4 | 203,0 | 151,6 | 68212 | 70 | 180,2 | 49615 | 64 | 1164 | 170 | 1175 | 6456 | 1610 | 720 | 6056 | 2028 | 2000 | 2028 | | | 76 | 28 | 4x19 | 4x1 1/4" |

Pay attention to the relation capacity / air volume !!

* Sound pressure indication (LpA) at 3 m distance each air cooler (+/- 2 dB(A)) , free field conditions, according EN13487

DVS 7mm Technical data

| Type DVS | 3x400V-50H-4pole (1500 min ⁻¹ nom.) | | | | 3x400V-50H-6pole (1000 min ⁻¹ nom.) | | | | Surface m ² | Internally volume dm ³ | Weight kg | Dimensions | | | | | | | Connections | | | |
|-------------|---|--------------------------------|---------------------------------|-----------------------------|---|--------------------------------|---------------------------------|-----------------------------|---------------------------|--------------------------------------|--------------|------------|----|----|----|----|----|----|-------------|-----|---------------|--------------|
| | R404A | | Air volume m ³ /h | LpA @ 3 m (+/-2 dB(A))** | R404A | | Air volume m ³ /h | LpA @ 3 m (+/-2 dB(A))** | | | | L | B | H | E1 | E2 | E3 | E4 | Refrigerant | | Hot gas mm | Drain NW" |
| | DTM = 7K Air mean = +2°C | DT1 = 8K (SC2) Air on = 0°C | | | DTM = 7K Air mean = +2°C | DT1 = 8K (SC2) Air on = 0°C | | | | | | | | | | | | | in | out | | |
| | kW | kW | kW | kW | kW | kW | mm | mm | | | | mm | mm | mm | mm | mm | mm | mm | mm | mm | mm | |

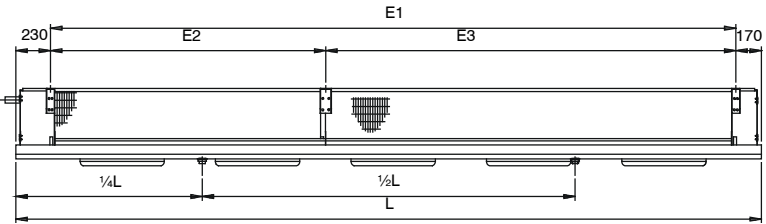
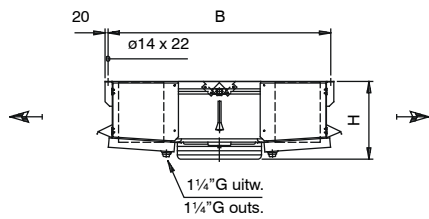

| | | | | | | | | | | | | | | | | | | | | | |
|----------|------|------|-------|----|------|------|------|----|-----|----|-----|------|------|-----|------|--|--|----|----|------|----------|
| 3.1.40.7 | 3,1 | 3,2 | 3467 | 52 | 2,4 | 2,3 | 2072 | 41 | 17 | 6 | 84 | 1056 | 1080 | 420 | 656 | | | 15 | 15 | 4x19 | 2x1 1/4" |
| 4.1.40.7 | 4,2 | 4,0 | 3402 | 52 | 3,5 | 3,1 | 2038 | 41 | 23 | 6 | 93 | 1056 | 1180 | 420 | 656 | | | 15 | 15 | 4x19 | 2x1 1/4" |
| 6.1.40.7 | 6,0 | 5,1 | 3271 | 52 | 4,5 | 3,7 | 1974 | 41 | 34 | 10 | 110 | 1056 | 1380 | 420 | 656 | | | 22 | 12 | 4x19 | 2x1 1/4" |
| 8.1.40.7 | 8,0 | 6,3 | 3145 | 52 | 6,5 | 4,6 | 1919 | 41 | 46 | 12 | 128 | 1056 | 1580 | 420 | 656 | | | 22 | 12 | 4x19 | 2x1 1/4" |
| 3.1.45.7 | 4,5 | 4,4 | 5267 | 56 | 3,9 | 3,7 | 3368 | 47 | 23 | 6 | 96 | 1056 | 1130 | 520 | 656 | | | 15 | 15 | 4x19 | 2x1 1/4" |
| 4.1.45.7 | 5,3 | 5,4 | 5144 | 56 | 4,6 | 4,2 | 3286 | 47 | 30 | 8 | 106 | 1056 | 1230 | 520 | 656 | | | 16 | 12 | 4x19 | 2x1 1/4" |
| 6.1.45.7 | 8,6 | 7,5 | 4915 | 56 | 7,3 | 5,9 | 3124 | 47 | 46 | 12 | 127 | 1056 | 1430 | 520 | 656 | | | 22 | 12 | 4x19 | 2x1 1/4" |
| 8.1.45.7 | 9,8 | 8,2 | 4709 | 56 | 8,4 | 6,6 | 2973 | 47 | 61 | 16 | 148 | 1056 | 1630 | 520 | 656 | | | 22 | 12 | 4x19 | 2x1 1/4" |
| 3.1.50.7 | 6,5 | 6,6 | 7601 | 63 | 5,3 | 5,3 | 5061 | 59 | 34 | 10 | 122 | 1356 | 1180 | 520 | 956 | | | 22 | 12 | 4x19 | 2x1 1/4" |
| 4.1.50.7 | 8,7 | 8,3 | 7486 | 63 | 7,6 | 6,9 | 4978 | 59 | 45 | 12 | 134 | 1356 | 1280 | 520 | 956 | | | 22 | 12 | 4x19 | 2x1 1/4" |
| 6.1.50.7 | 12,8 | 11,2 | 7263 | 63 | 11,0 | 9,0 | 4820 | 59 | 68 | 18 | 162 | 1356 | 1480 | 520 | 956 | | | 28 | 12 | 4x19 | 2x1 1/4" |
| 8.1.50.7 | 16,6 | 13,5 | 7052 | 63 | 14,1 | 10,5 | 4672 | 59 | 91 | 24 | 190 | 1356 | 1680 | 520 | 956 | | | 28 | 16 | 4x19 | 2x1 1/4" |
| 3.1.56.7 | 9,1 | 9,1 | 10722 | 63 | 7,9 | 7,5 | 6835 | 53 | 47 | 12 | 146 | 1456 | 1240 | 620 | 1056 | | | 22 | 12 | 4x19 | 2x1 1/4" |
| 4.1.56.7 | 11,4 | 11,3 | 10577 | 63 | 9,2 | 8,4 | 6741 | 53 | 63 | 16 | 164 | 1456 | 1340 | 620 | 1056 | | | 22 | 12 | 4x19 | 2x1 1/4" |
| 6.1.56.7 | 18,2 | 15,8 | 10297 | 63 | 15,1 | 12,3 | 6557 | 53 | 95 | 24 | 199 | 1456 | 1540 | 620 | 1056 | | | 28 | 12 | 4x19 | 2x1 1/4" |
| 8.1.56.7 | 22,3 | 18,6 | 10034 | 63 | 19,1 | 14,5 | 6382 | 53 | 127 | 32 | 234 | 1456 | 1740 | 620 | 1056 | | | 35 | 16 | 4x19 | 2x1 1/4" |
| 3.1.63.7 | 11,3 | 11,4 | 13095 | 63 | 10,0 | 9,8 | 9630 | 58 | 57 | 16 | 162 | 1456 | 1310 | 720 | 1056 | | | 28 | 12 | 4x19 | 2x1 1/4" |
| 4.1.63.7 | 15,0 | 14,3 | 12921 | 63 | 13,1 | 12,2 | 9492 | 58 | 76 | 20 | 181 | 1456 | 1410 | 720 | 1056 | | | 28 | 12 | 4x19 | 2x1 1/4" |
| 6.1.63.7 | 22,0 | 19,2 | 12575 | 63 | 19,1 | 15,8 | 9218 | 58 | 114 | 30 | 221 | 1456 | 1610 | 720 | 1056 | | | 35 | 16 | 4x19 | 2x1 1/4" |
| 8.1.63.7 | 28,4 | 22,8 | 12240 | 63 | 24,5 | 19,1 | 8953 | 58 | 152 | 38 | 262 | 1456 | 1810 | 720 | 1056 | | | 35 | 16 | 4x19 | 2x1 1/4" |

| | | | | | | | | | | | | | | | | | | | | | |
|----------|------|------|-------|----|------|------|-------|----|-----|----|-----|------|------|-----|------|--|--|----|----|------|----------|
| 3.2.40.7 | 6,2 | 6,3 | 6928 | 55 | 4,8 | 4,6 | 4141 | 44 | 34 | 10 | 128 | 1656 | 1080 | 420 | 1256 | | | 22 | 12 | 4x19 | 2x1 1/4" |
| 4.2.40.7 | 8,5 | 7,9 | 6799 | 55 | 7,0 | 6,2 | 4072 | 44 | 45 | 12 | 141 | 1656 | 1180 | 420 | 1256 | | | 22 | 12 | 4x19 | 2x1 1/4" |
| 6.2.40.7 | 12,4 | 10,6 | 6534 | 55 | 10,1 | 7,9 | 3944 | 44 | 68 | 18 | 172 | 1656 | 1380 | 420 | 1256 | | | 22 | 12 | 4x19 | 2x1 1/4" |
| 8.2.40.7 | 15,9 | 12,6 | 6278 | 55 | 12,9 | 9,1 | 3832 | 44 | 91 | 24 | 201 | 1656 | 1580 | 420 | 1256 | | | 28 | 16 | 4x19 | 2x1 1/4" |
| 3.2.45.7 | 8,9 | 8,8 | 10527 | 59 | 7,7 | 7,3 | 6731 | 50 | 45 | 12 | 143 | 1656 | 1130 | 520 | 1256 | | | 22 | 12 | 4x19 | 2x1 1/4" |
| 4.2.45.7 | 10,6 | 10,7 | 10279 | 59 | 9,1 | 8,3 | 6565 | 50 | 61 | 16 | 160 | 1656 | 1230 | 520 | 1256 | | | 22 | 12 | 4x19 | 2x1 1/4" |
| 6.2.45.7 | 17,1 | 15,1 | 9819 | 59 | 14,5 | 11,8 | 6238 | 50 | 91 | 24 | 196 | 1656 | 1430 | 520 | 1256 | | | 28 | 16 | 4x19 | 2x1 1/4" |
| 8.2.45.7 | 19,5 | 16,3 | 9403 | 59 | 16,8 | 13,2 | 5936 | 50 | 122 | 30 | 231 | 1656 | 1630 | 520 | 1256 | | | 28 | 16 | 4x19 | 2x1 1/4" |
| 3.2.50.7 | 13,4 | 13,3 | 15196 | 66 | 11,6 | 11,0 | 10118 | 62 | 68 | 18 | 196 | 2256 | 1180 | 520 | 1856 | | | 28 | 12 | 4x19 | 2x1 1/4" |
| 4.2.50.7 | 17,7 | 16,7 | 14966 | 66 | 15,2 | 13,7 | 9950 | 62 | 91 | 24 | 220 | 2256 | 1280 | 520 | 1856 | | | 28 | 16 | 4x19 | 2x1 1/4" |
| 6.2.50.7 | 25,9 | 22,4 | 14519 | 66 | 22,0 | 18,0 | 9633 | 62 | 137 | 34 | 268 | 2256 | 1480 | 520 | 1856 | | | 35 | 16 | 4x19 | 2x1 1/4" |
| 8.2.50.7 | 33,4 | 27,0 | 14093 | 66 | 28,1 | 20,9 | 9336 | 62 | 182 | 46 | 317 | 2256 | 1680 | 520 | 1856 | | | 35 | 16 | 4x19 | 2x1 1/4" |
| 3.2.56.7 | 18,8 | 18,9 | 21437 | 66 | 15,9 | 15,1 | 13666 | 56 | 95 | 24 | 236 | 2456 | 1240 | 620 | 2056 | | | 35 | 16 | 4x19 | 2x1 1/4" |
| 4.2.56.7 | 24,2 | 22,7 | 21145 | 66 | 20,7 | 18,6 | 13477 | 56 | 126 | 32 | 267 | 2456 | 1340 | 620 | 2056 | | | 35 | 16 | 4x19 | 2x1 1/4" |
| 6.2.56.7 | 36,2 | 31,6 | 20584 | 66 | 30,3 | 24,7 | 13109 | 55 | 190 | 48 | 330 | 2456 | 1540 | 620 | 2056 | | | 42 | 16 | 4x19 | 2x1 1/4" |
| 8.2.56.7 | 45,8 | 37,4 | 20055 | 66 | 38,3 | 28,9 | 12754 | 55 | 253 | 64 | 393 | 2456 | 1740 | 620 | 2056 | | | 42 | 22 | 4x19 | 2x1 1/4" |
| 3.2.63.7 | 22,7 | 22,8 | 26184 | 66 | 19,9 | 19,6 | 19255 | 60 | 114 | 30 | 263 | 2456 | 1310 | 720 | 2056 | | | 35 | 16 | 4x19 | 2x1 1/4" |
| 4.2.63.7 | 30,0 | 28,7 | 25834 | 66 | 26,4 | 24,3 | 18978 | 60 | 152 | 38 | 298 | 2456 | 1410 | 720 | 2056 | | | 35 | 16 | 4x19 | 2x1 1/4" |
| 6.2.63.7 | 43,8 | 38,3 | 25139 | 66 | 38,3 | 32,0 | 18428 | 60 | 228 | 58 | 370 | 2456 | 1610 | 720 | 2056 | | | 42 | 16 | 4x19 | 2x1 1/4" |
| 8.2.63.7 | 56,7 | 45,5 | 24464 | 66 | 49,1 | 38,1 | 17895 | 60 | 304 | 76 | 440 | 2456 | 1810 | 720 | 2056 | | | 42 | 22 | 4x19 | 2x1 1/4" |

| | | | | | | | | | | | | | | | | | | | | | |
|----------|------|------|-------|----|------|------|-------|----|-----|-----|-----|------|------|-----|------|------|------|----|----|------|----------|
| 3.3.45.7 | 13,6 | 13,5 | 15787 | 61 | 11,5 | 11,0 | 10095 | 52 | 68 | 18 | 193 | 2256 | 1130 | 520 | 1856 | | | 28 | 16 | 4x19 | 2x1 1/4" |
| 4.3.45.7 | 17,9 | 16,9 | 15415 | 61 | 15,1 | 13,6 | 9845 | 51 | 91 | 24 | 218 | 2256 | 1230 | 520 | 1856 | | | 28 | 16 | 4x19 | 2x1 1/4" |
| 6.3.45.7 | 26,0 | 22,6 | 14721 | 61 | 21,8 | 17,6 | 9352 | 51 | 137 | 34 | 265 | 2256 | 1430 | 520 | 1856 | | | 35 | 16 | 4x19 | 2x1 1/4" |
| 8.3.45.7 | 33,4 | 27,0 | 14097 | 61 | 27,6 | 20,2 | 8898 | 51 | 182 | 46 | 314 | 2256 | 1630 | 520 | 1856 | | | 35 | 16 | 4x19 | 2x1 1/4" |
| 3.3.50.7 | 19,8 | 19,9 | 22792 | 67 | 17,3 | 16,4 | 15176 | 63 | 102 | 26 | 270 | 3156 | 1180 | 520 | 2756 | | | 35 | 16 | 4x19 | 2x1 1/4" |
| 4.3.50.7 | 25,6 | 24,8 | 22446 | 67 | 20,8 | 19,3 | 14924 | 63 | 137 | 34 | 305 | 3156 | 1280 | 520 | 2756 | | | 35 | 16 | 4x19 | 2x1 1/4" |
| 6.3.50.7 | 38,3 | 33,3 | 21774 | 67 | 32,9 | 26,8 | 14447 | 63 | 205 | 52 | 376 | 3156 | 1480 | 520 | 2756 | | | 42 | 16 | 4x19 | 2x1 1/4" |
| 8.3.50.7 | 48,2 | 38,1 | 21133 | 67 | 38,3 | 29,5 | 14002 | 63 | 274 | 68 | 445 | 3156 | 1680 | 520 | 2756 | | | 42 | 22 | 4x19 | 2x1 1/4" |
| 3.3.56.7 | 28,3 | 27,9 | 32153 | 67 | 24,1 | 22,8 | 20498 | 57 | 142 | 36 | 331 | 3456 | 1240 | 620 | 3056 | 1028 | 2028 | 35 | 16 | 4x19 | 2x1 1/4" |
| 4.3.56.7 | 37,5 | 35,8 | 31714 | 67 | 31,7 | 28,3 | 20214 | 57 | 190 | 48 | 375 | 3456 | 1340 | 620 | 3056 | 1028 | 2028 | 42 | 16 | 4x19 | 2x1 1/4" |
| 6.3.56.7 | 54,9 | 47,6 | 30872 | 67 | 45,9 | 37,0 | 19659 | 57 | 285 | 72 | 464 | 3456 | 1540 | 620 | 3056 | 1028 | 2028 | 42 | 22 | 4x19 | 2x1 1/4" |
| 8.3.56.7 | 71,0 | 57,2 | 30078 | 67 | 58,5 | 43,2 | 19128 | 57 | 380 | 94 | 555 | 3456 | 1740 | 620 | 3056 | 1028 | 2028 | 54 | 22 | 4x35 | 2x1 1/4" |
| 3.3.63.7 | 34,6 | 34,5 | 39273 | 67 | 30,8 | 29,8 | 28881 | 62 | 171 | 44 | 364 | 3456 | 1310 | 720 | 3056 | 1028 | 2028 | 42 | 16 | 4x19 | 2x1 1/4" |
| 4.3.63.7 | 45,3 | 43,3 | 38747 | 67 | 39,4 | 36,4 | 28465 | 62 | 228 | 58 | 416 | 3456 | 1410 | 720 | 3056 | 1028 | 2028 | 42 | 16 | 4x19 | 2x1 1/4" |
| 6.3.63.7 | 67,2 | 58,2 | 37702 | 67 | 58,9 | 48,5 | 27638 | 62 | 342 | 86 | 518 | 3456 | 1610 | 720 | 3056 | 1028 | 2028 | 54 | 22 | 4x35 | 2x1 1/4" |
| 8.3.63.7 | 85,6 | 68,2 | 36689 | 67 | 73,2 | 56,3 | 26834 | 62 | 456 | 114 | 622 | 3456 | 1810 | 720 | 3056 | 1028 | 2028 | 54 | 22 | 4x35 | 2x1 1/4" |

Pay attention to the relation capacity / air volume !!

* Sound pressure indication (LpA) at 3 m distance each air cooler (+/- 2 dB(A)), free field conditions, according EN13487

DVS 7mm Technical data

| Type DVS | 3x400V-50H-4pole (1500 min ⁻¹ nom.) | | | | | | 3x400V-50H-6pole (1000 min ⁻¹ nom.) | | | | | | Dimensions | | | | | | | | Connections | | | |
|-------------|---|--------------------------------|---------------------------------|----------------------------|-----------------------------|--------------------------------|---|----------------------------|---------------------------|--------------------------------------|--------------|---------|------------|---------|----------|----------|----------|----------|-------------|-----------|---------------|--------------|--|--|
| | R404A | | Air volume m ³ /h | LpA @ 3 m (+/-2 dB(A))* | R404A | | Air volume m ³ /h | LpA @ 3 m (+/-2 dB(A))* | Surface m ² | Internally volume dm ³ | Weight kg | L mm | B mm | H mm | E1 mm | E2 mm | E3 mm | E4 mm | Refrigerant | | | | | |
| | DTM = 7K Air mean = +2°C | DT1 = 8K (SC2) Air on = 0°C | | | DTM = 7K Air mean = +2°C | DT1 = 8K (SC2) Air on = 0°C | | | | | | | | | | | | | in mm | out mm | Hot gas mm | Drain NW" | | |
| | | | kW | kW | | | kW | kW | | | | | | | | | | | | | | | | |

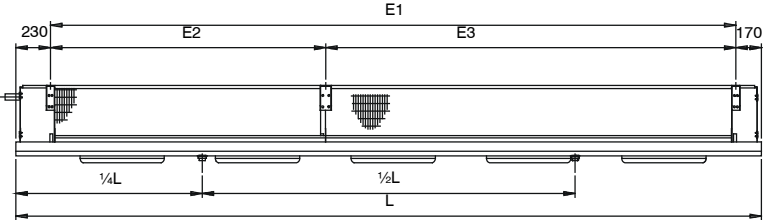
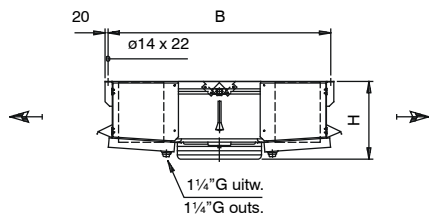

| | | | | | | | | | | | | | | | | | | | | | | | |
|----------|-------|------|-------|----|-------|------|-------|----|-----|-----|-----|------|------|-----|------|------|------|--|--|----|----|------|----------|
| 3.4.45.7 | 18,3 | 18,1 | 21047 | 62 | 15,5 | 14,8 | 13459 | 53 | 91 | 24 | 244 | 2856 | 1130 | 520 | 2456 | | | | | 28 | 16 | 4x19 | 2x1 1/4" |
| 4.4.45.7 | 21,5 | 21,2 | 20551 | 62 | 19,0 | 17,1 | 13124 | 53 | 121 | 30 | 274 | 2856 | 1230 | 520 | 2456 | | | | | 35 | 16 | 4x19 | 2x1 1/4" |
| 6.4.45.7 | 35,1 | 30,4 | 19624 | 62 | 29,1 | 23,5 | 12467 | 52 | 182 | 46 | 338 | 2856 | 1430 | 520 | 2456 | | | | | 42 | 16 | 4x19 | 2x1 1/4" |
| 8.4.45.7 | 40,3 | 33,5 | 18791 | 62 | 34,6 | 26,4 | 11859 | 52 | 243 | 60 | 400 | 2856 | 1630 | 520 | 2456 | | | | | 42 | 16 | 4x19 | 2x1 1/4" |
| 3.4.50.7 | 27,3 | 27,0 | 30388 | 68 | 23,5 | 22,3 | 20233 | 64 | 136 | 34 | 348 | 4056 | 1180 | 520 | 3656 | 1828 | 1828 | | | 35 | 16 | 4x19 | 2x1 1/4" |
| 4.4.50.7 | 36,2 | 34,0 | 29926 | 68 | 30,9 | 27,7 | 19898 | 64 | 182 | 46 | 395 | 4056 | 1280 | 520 | 3656 | 1828 | 1828 | | | 42 | 16 | 4x19 | 2x1 1/4" |
| 6.4.50.7 | 52,9 | 45,6 | 29029 | 68 | 44,6 | 35,9 | 19259 | 64 | 273 | 68 | 485 | 4056 | 1480 | 520 | 3656 | 1828 | 1828 | | | 42 | 22 | 4x19 | 2x1 1/4" |
| 8.4.50.7 | 68,2 | 54,4 | 28174 | 68 | 56,8 | 41,8 | 18666 | 64 | 365 | 90 | 576 | 4056 | 1680 | 520 | 3656 | 1828 | 1828 | | | 54 | 22 | 4x19 | 2x1 1/4" |
| 3.4.56.7 | 38,0 | 38,2 | 42869 | 68 | 30,9 | 29,9 | 27329 | 58 | 190 | 48 | 428 | 4456 | 1240 | 620 | 4056 | 2028 | 2028 | | | 42 | 22 | 4x19 | 2x1 1/4" |
| 4.4.56.7 | 49,5 | 46,5 | 42282 | 68 | 42,3 | 37,7 | 26949 | 58 | 253 | 64 | 485 | 4456 | 1340 | 620 | 4056 | 2028 | 2028 | | | 42 | 22 | 4x19 | 2x1 1/4" |
| 6.4.56.7 | 73,4 | 63,4 | 41159 | 68 | 61,2 | 49,5 | 26210 | 58 | 380 | 94 | 604 | 4456 | 1540 | 620 | 4056 | 2028 | 2028 | | | 54 | 22 | 4x35 | 2x1 1/4" |
| 8.4.56.7 | 93,8 | 76,0 | 40100 | 68 | 78,1 | 57,8 | 25502 | 58 | 507 | 126 | 720 | 4456 | 1740 | 620 | 4056 | 2028 | 2028 | | | 54 | 22 | 4x35 | 2x1 1/4" |
| 3.4.63.7 | 46,0 | 46,2 | 52361 | 68 | 40,8 | 39,3 | 38505 | 63 | 228 | 58 | 472 | 4456 | 1310 | 720 | 4056 | 2028 | 2028 | | | 42 | 22 | 4x35 | 2x1 1/4" |
| 4.4.63.7 | 60,7 | 58,0 | 51660 | 68 | 53,8 | 49,0 | 37951 | 63 | 304 | 76 | 539 | 4456 | 1410 | 720 | 4056 | 2028 | 2028 | | | 54 | 22 | 4x35 | 2x1 1/4" |
| 6.4.63.7 | 88,7 | 76,9 | 50266 | 68 | 78,2 | 65,0 | 36847 | 63 | 456 | 114 | 674 | 4456 | 1610 | 720 | 4056 | 2028 | 2028 | | | 54 | 22 | 4x35 | 2x1 1/4" |
| 8.4.63.7 | 114,6 | 92,0 | 48914 | 68 | 100,2 | 76,6 | 35776 | 63 | 608 | 150 | 807 | 4456 | 1810 | 720 | 4056 | 2028 | 2028 | | | 64 | 28 | 4x35 | 2x1 1/4" |

| | | | | | | | | | | | | | | | | | | | | | | | |
|----------|-------|-------|-------|----|-------|------|-------|----|-----|-----|-----|------|------|-----|------|------|------|--|--|----|----|------|----------|
| 3.5.50.7 | 34,5 | 34,2 | 37985 | 69 | 29,3 | 28,0 | 25291 | 65 | 171 | 44 | 423 | 4956 | 1180 | 520 | 4556 | 1828 | 2728 | | | 42 | 16 | 4x35 | 4x1 1/4" |
| 4.5.50.7 | 42,4 | 39,7 | 37406 | 69 | 37,4 | 33,6 | 24871 | 65 | 228 | 58 | 480 | 4956 | 1280 | 520 | 4556 | 1828 | 2728 | | | 42 | 16 | 4x35 | 4x1 1/4" |
| 6.5.50.7 | 66,6 | 57,3 | 36283 | 69 | 55,6 | 44,5 | 24074 | 65 | 342 | 86 | 591 | 4956 | 1480 | 520 | 4556 | 1828 | 2728 | | | 54 | 22 | 4x35 | 4x1 1/4" |
| 8.5.50.7 | 80,0 | 65,6 | 35215 | 69 | 68,9 | 52,2 | 23330 | 65 | 456 | 114 | 704 | 4956 | 1680 | 520 | 4556 | 1828 | 2728 | | | 54 | 22 | 4x35 | 4x1 1/4" |
| 3.5.56.7 | 47,8 | 48,0 | 53583 | 69 | 40,5 | 38,3 | 34161 | 59 | 237 | 60 | 520 | 5456 | 1240 | 620 | 5056 | 2028 | 3028 | | | 42 | 22 | 4x35 | 4x1 1/4" |
| 4.5.56.7 | 63,4 | 60,2 | 52853 | 69 | 51,7 | 46,6 | 33686 | 59 | 316 | 78 | 593 | 5456 | 1340 | 620 | 5056 | 2028 | 3028 | | | 54 | 22 | 4x35 | 4x1 1/4" |
| 6.5.56.7 | 92,8 | 80,1 | 51447 | 69 | 77,2 | 62,0 | 32761 | 58 | 475 | 118 | 738 | 5456 | 1540 | 620 | 5056 | 2028 | 3028 | | | 54 | 22 | 4x35 | 4x1 1/4" |
| 8.5.56.7 | 119,9 | 94,8 | 50121 | 69 | 95,3 | 70,4 | 31875 | 58 | 633 | 156 | 881 | 5456 | 1740 | 620 | 5056 | 2028 | 3028 | | | 64 | 28 | 4x35 | 4x1 1/4" |
| 3.5.63.7 | 57,7 | 56,8 | 65451 | 69 | 51,7 | 49,7 | 48132 | 63 | 285 | 72 | 575 | 5456 | 1310 | 720 | 5056 | 2028 | 3028 | | | 54 | 22 | 4x35 | 4x1 1/4" |
| 4.5.63.7 | 76,3 | 71,9 | 64572 | 69 | 68,1 | 62,1 | 47436 | 63 | 380 | 94 | 657 | 5456 | 1410 | 720 | 5056 | 2028 | 3028 | | | 54 | 22 | 4x35 | 4x1 1/4" |
| 6.5.63.7 | 111,7 | 97,0 | 62829 | 69 | 99,0 | 81,8 | 46055 | 63 | 570 | 142 | 823 | 5456 | 1610 | 720 | 5056 | 2028 | 3028 | | | 64 | 28 | 4x35 | 4x1 1/4" |
| 8.5.63.7 | 144,5 | 116,4 | 61137 | 69 | 126,8 | 96,0 | 44717 | 63 | 760 | 188 | 989 | 5456 | 1810 | 720 | 5056 | 2028 | 3028 | | | 64 | 28 | 4x35 | 4x1 1/4" |

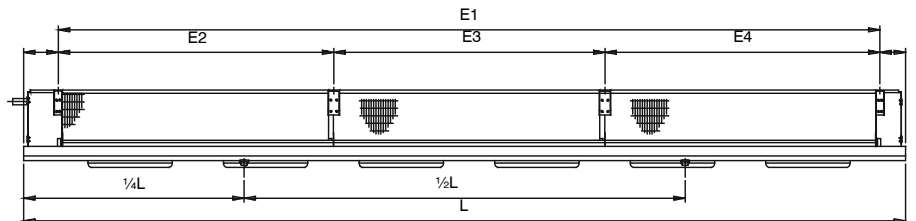
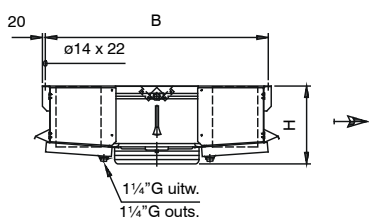

| | | | | | | | | | | | | | | | | | | | | | | | |
|----------|-------|-------|-------|----|-------|-------|-------|----|-----|-----|------|------|------|-----|------|------|------|------|--|----|----|------|----------|
| 3.6.50.7 | 40,3 | 40,1 | 45579 | 69 | 35,2 | 33,2 | 30348 | 65 | 205 | 52 | 498 | 5856 | 1180 | 520 | 5456 | 1828 | 1828 | 1828 | | 42 | 16 | 4x35 | 4x1 1/4" |
| 4.6.50.7 | 51,5 | 49,9 | 44887 | 69 | 41,6 | 38,5 | 29844 | 65 | 273 | 68 | 564 | 5856 | 1280 | 520 | 5456 | 1828 | 1800 | 1828 | | 42 | 22 | 4x35 | 4x1 1/4" |
| 6.6.50.7 | 78,0 | 67,5 | 43540 | 69 | 66,8 | 54,2 | 28887 | 65 | 410 | 102 | 698 | 5856 | 1480 | 520 | 5456 | 1828 | 1800 | 1828 | | 54 | 22 | 4x35 | 4x1 1/4" |
| 8.6.50.7 | 96,7 | 76,2 | 42255 | 69 | 76,4 | 59,9 | 27995 | 65 | 547 | 136 | 830 | 5856 | 1680 | 520 | 5456 | 1828 | 1800 | 1828 | | 54 | 28 | 4x35 | 4x1 1/4" |
| 3.6.56.7 | 57,5 | 57,5 | 64300 | 69 | 48,7 | 46,1 | 40993 | 59 | 285 | 72 | 617 | 6456 | 1240 | 620 | 6056 | 2028 | 2000 | 2028 | | 54 | 22 | 4x35 | 4x1 1/4" |
| 4.6.56.7 | 76,0 | 72,1 | 63421 | 69 | 64,1 | 57,2 | 40422 | 59 | 380 | 94 | 703 | 6456 | 1340 | 620 | 6056 | 2028 | 2000 | 2028 | | 54 | 22 | 4x35 | 4x1 1/4" |
| 6.6.56.7 | 111,3 | 96,4 | 61735 | 69 | 92,8 | 74,5 | 39311 | 59 | 570 | 142 | 874 | 6456 | 1540 | 620 | 6056 | 2028 | 2000 | 2028 | | 64 | 28 | 4x35 | 4x1 1/4" |
| 8.6.56.7 | 144,0 | 115,5 | 60143 | 69 | 118,3 | 86,5 | 38248 | 59 | 760 | 188 | 1046 | 6456 | 1740 | 620 | 6056 | 2028 | 2000 | 2028 | | 64 | 28 | 4x35 | 4x1 1/4" |
| 3.6.63.7 | 69,2 | 69,7 | 78539 | 70 | 60,2 | 59,2 | 57758 | 64 | 342 | 86 | 683 | 6456 | 1310 | 720 | 6056 | 2028 | 2000 | 2028 | | 54 | 22 | 4x35 | 4x1 1/4" |
| 4.6.63.7 | 82,2 | 87,3 | 77485 | 70 | 79,3 | 73,1 | 56923 | 64 | 456 | 114 | 780 | 6456 | 1410 | 720 | 6056 | 2028 | 2000 | 2028 | | 54 | 22 | 4x35 | 4x1 1/4" |
| 6.6.63.7 | 133,7 | 115,7 | 75393 | 70 | 115,1 | 95,7 | 55265 | 64 | 684 | 170 | 978 | 6456 | 1610 | 720 | 6056 | 2028 | 2000 | 2028 | | 64 | 28 | 4x35 | 4x1 1/4" |
| 8.6.63.7 | 172,6 | 136,6 | 73362 | 69 | 147,0 | 113,9 | 53658 | 64 | 912 | 226 | 1174 | 6456 | 1810 | 720 | 6056 | 2028 | 2000 | 2028 | | 76 | 28 | 4x35 | 4x1 1/4" |

Pay attention to the relation capacity / air volume !!

* Sound pressure indication (LpA) at 3 m distance each air cooler (+/- 2 dB(A)) , free field conditions, according EN13487

DVS 10mm Technical data

| Type DVS | 3x400V-50H-4pole (1500 min ⁻¹ nom.) | | | | 3x400V-50H-6pole (1000 min ⁻¹ nom.) | | | | Surface | Internally volume | Weight | Dimensions | | | | | | | Connections | | | |
|-------------|---|--------------------------------|-------------------|-----------------------------|---|--------------------------------|-------------------|-----------------------------|---------|-------------------|--------|----------------|-----------------|----|----|----|----|----|-------------|-----|---------|-------|
| | R404A | | Air volume | LpA @ 3 m (+/-2 dB(A))** | R404A | | Air volume | LpA @ 3 m (+/-2 dB(A))** | | | | L | B | H | E1 | E2 | E3 | E4 | Refrigerant | | | Drain |
| | DTM = 7K Air mean = +2°C | DT1 = 8K (SC2) Air on = 0°C | | | DTM = 7K Air mean = +2°C | DT1 = 8K (SC2) Air on = 0°C | | | | | | | | | | | | | in | out | Hot gas | |
| | kW | kW | m ³ /h | dB(A) | kW | kW | m ³ /h | dB(A) | | | | m ² | dm ³ | kg | mm | mm | mm | mm | mm | mm | mm | mm |

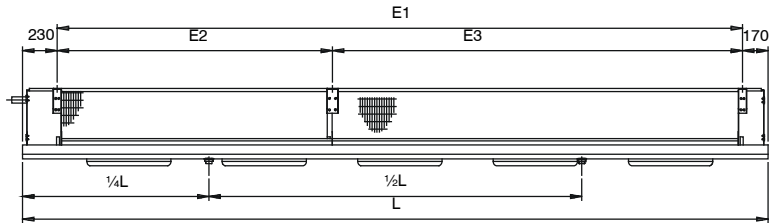
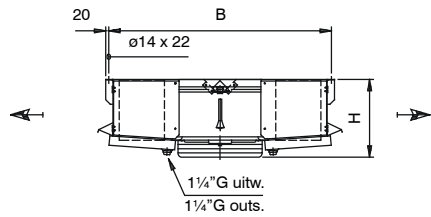

| | | | | | | | | | | | | | | | | | | | | | | |
|-----------|------|------|-------|----|------|------|------|----|-----|----|-----|------|------|-----|------|--|--|--|----|----|------|----------|
| 8.1.40.10 | 6,2 | 5,4 | 3352 | 52 | 4,6 | 3,7 | 2012 | 41 | 33 | 12 | 124 | 1056 | 1580 | 420 | 656 | | | | 16 | 12 | 4x19 | 2x1 1/4" |
| 1.1.40.10 | 7,5 | 6,2 | 3275 | 52 | 5,9 | 4,4 | 1976 | 41 | 41 | 16 | 139 | 1056 | 1780 | 420 | 656 | | | | 22 | 12 | 4x19 | 2x1 1/4" |
| 8.1.45.10 | 8,3 | 7,4 | 5055 | 56 | 7,0 | 5,8 | 3223 | 47 | 44 | 16 | 141 | 1056 | 1630 | 520 | 656 | | | | 22 | 12 | 4x19 | 2x1 1/4" |
| 1.1.45.10 | 10,2 | 8,4 | 4921 | 56 | 7,7 | 6,3 | 3128 | 47 | 55 | 20 | 161 | 1056 | 1830 | 520 | 656 | | | | 22 | 12 | 4x19 | 2x1 1/4" |
| 8.1.50.10 | 13,1 | 11,4 | 7400 | 63 | 10,5 | 8,6 | 4917 | 59 | 66 | 24 | 180 | 1356 | 1680 | 520 | 956 | | | | 28 | 12 | 4x19 | 2x1 1/4" |
| 1.1.50.10 | 16,0 | 13,1 | 7270 | 63 | 13,0 | 10,1 | 4824 | 59 | 82 | 30 | 205 | 1356 | 1880 | 520 | 956 | | | | 28 | 12 | 4x19 | 2x1 1/4" |
| 8.1.56.10 | 18,3 | 16,0 | 10469 | 63 | 14,7 | 12,1 | 6670 | 53 | 91 | 32 | 219 | 1456 | 1740 | 620 | 1056 | | | | 28 | 12 | 4x19 | 2x1 1/4" |
| 1.1.56.10 | 21,6 | 17,8 | 10304 | 63 | 17,5 | 13,8 | 6562 | 53 | 114 | 40 | 250 | 1456 | 1940 | 620 | 1056 | | | | 28 | 16 | 4x19 | 2x1 1/4" |
| 8.1.63.10 | 22,1 | 19,5 | 12789 | 63 | 19,1 | 16,1 | 9388 | 58 | 109 | 38 | 244 | 1456 | 1810 | 720 | 1056 | | | | 35 | 16 | 4x19 | 2x1 1/4" |
| 1.1.63.10 | 27,3 | 22,6 | 12584 | 63 | 23,2 | 18,3 | 9226 | 58 | 137 | 48 | 280 | 1456 | 2010 | 720 | 1056 | | | | 35 | 16 | 4x19 | 2x1 1/4" |

| | | | | | | | | | | | | | | | | | | | | | | |
|-----------|------|------|-------|----|------|------|-------|----|-----|----|-----|------|------|-----|------|--|--|--|----|----|------|----------|
| 8.2.40.10 | 12,4 | 10,7 | 6698 | 55 | 9,6 | 7,8 | 4022 | 44 | 65 | 24 | 190 | 1656 | 1580 | 420 | 1256 | | | | 22 | 12 | 4x19 | 2x1 1/4" |
| 1.2.40.10 | 15,1 | 12,3 | 6542 | 55 | 11,7 | 8,8 | 3948 | 44 | 82 | 30 | 217 | 1656 | 1780 | 420 | 1256 | | | | 28 | 12 | 4x19 | 2x1 1/4" |
| 8.2.45.10 | 16,6 | 14,8 | 10099 | 59 | 14,0 | 11,7 | 6439 | 50 | 87 | 30 | 218 | 1656 | 1630 | 520 | 1256 | | | | 28 | 16 | 4x19 | 2x1 1/4" |
| 1.2.45.10 | 20,3 | 17,3 | 9830 | 59 | 16,9 | 13,2 | 6246 | 50 | 109 | 38 | 249 | 1656 | 1830 | 520 | 1256 | | | | 28 | 16 | 4x19 | 2x1 1/4" |
| 8.2.50.10 | 26,1 | 22,8 | 14794 | 66 | 20,9 | 17,2 | 9829 | 62 | 131 | 46 | 296 | 2256 | 1680 | 520 | 1856 | | | | 35 | 16 | 4x19 | 2x1 1/4" |
| 1.2.50.10 | 32,0 | 26,2 | 14530 | 65 | 26,0 | 20,2 | 9641 | 61 | 164 | 58 | 340 | 2256 | 1880 | 520 | 1856 | | | | 35 | 16 | 4x19 | 2x1 1/4" |
| 8.2.56.10 | 36,5 | 32,1 | 20928 | 66 | 29,3 | 24,1 | 13336 | 55 | 182 | 64 | 364 | 2456 | 1740 | 620 | 2056 | | | | 42 | 16 | 4x19 | 2x1 1/4" |
| 1.2.56.10 | 42,3 | 35,6 | 20598 | 66 | 35,0 | 27,6 | 13117 | 55 | 228 | 78 | 416 | 2456 | 1940 | 620 | 2056 | | | | 42 | 22 | 4x19 | 2x1 1/4" |
| 8.2.63.10 | 44,2 | 38,9 | 25568 | 66 | 38,2 | 32,2 | 18768 | 60 | 219 | 76 | 405 | 2456 | 1810 | 720 | 2056 | | | | 42 | 16 | 4x19 | 2x1 1/4" |
| 1.2.63.10 | 54,4 | 45,1 | 25157 | 66 | 46,6 | 36,7 | 18443 | 60 | 274 | 94 | 467 | 2456 | 2010 | 720 | 2056 | | | | 42 | 22 | 4x35 | 2x1 1/4" |

| | | | | | | | | | | | | | | | | | | | | | | |
|-----------|------|------|-------|----|------|------|-------|----|-----|-----|-----|------|------|-----|------|------|------|--|----|----|------|----------|
| 8.3.45.10 | 26,4 | 23,1 | 15144 | 61 | 20,7 | 17,0 | 9655 | 51 | 131 | 46 | 294 | 2256 | 1630 | 520 | 1856 | | | | 35 | 16 | 4x19 | 2x1 1/4" |
| 1.3.45.10 | 32,2 | 26,5 | 14738 | 60 | 25,6 | 19,8 | 9365 | 51 | 164 | 58 | 338 | 2256 | 1830 | 520 | 1856 | | | | 35 | 16 | 4x19 | 2x1 1/4" |
| 8.3.50.10 | 36,2 | 31,9 | 22188 | 67 | 30,9 | 25,8 | 14740 | 63 | 197 | 68 | 414 | 3156 | 1680 | 520 | 2756 | | | | 42 | 16 | 4x19 | 2x1 1/4" |
| 1.3.50.10 | 47,4 | 38,7 | 21791 | 67 | 37,5 | 29,8 | 14458 | 63 | 246 | 86 | 475 | 3156 | 1880 | 520 | 2756 | | | | 42 | 22 | 4x19 | 2x1 1/4" |
| 8.3.56.10 | 55,3 | 48,1 | 31390 | 67 | 43,4 | 35,6 | 20000 | 57 | 273 | 94 | 511 | 3456 | 1740 | 620 | 3056 | 1028 | 2028 | | 42 | 22 | 4x35 | 2x1 1/4" |
| 1.3.56.10 | 67,7 | 55,6 | 30893 | 67 | 52,8 | 40,2 | 19672 | 57 | 342 | 118 | 589 | 3456 | 1940 | 620 | 3056 | 1028 | 2028 | | 54 | 22 | 4x35 | 2x1 1/4" |
| 8.3.63.10 | 65,9 | 57,7 | 38347 | 67 | 57,2 | 48,2 | 28148 | 62 | 328 | 114 | 569 | 3456 | 1810 | 720 | 3056 | 1028 | 2028 | | 54 | 22 | 4x35 | 2x1 1/4" |
| 1.3.63.10 | 81,9 | 67,5 | 37729 | 67 | 69,7 | 55,4 | 27658 | 62 | 410 | 142 | 659 | 3456 | 2010 | 720 | 3056 | 1028 | 2028 | | 54 | 22 | 4x35 | 2x1 1/4" |

Pay attention to the relation capacity / air volume !!

* Sound pressure indication (LpA) at 3 m distance each air cooler (+/- 2 dB(A)), free field conditions, according EN13487

DVS 10mm Technical data

| Type DVS | 3x400V-50H-4pole (1500 min ⁻¹ nom.) | | | | | | 3x400V-50H-6pole (1000 min ⁻¹ nom.) | | | | | | Dimensions | | | | | | | | Connections | | | |
|-------------|---|--------------------------------|-------------------|-----------------------------|-----------------------------|--------------------------------|---|-----------------------------|----------------|-------------------|--------|----|------------|----|----|----|----|----|-------------|-----|-------------|-------|-----|--|
| | R404A | | Air volume | LpA @ 3 m (+/-2 dB(A))** | R404A | | Air volume | LpA @ 3 m (+/-2 dB(A))** | Surface | Internally volume | Weight | L | B | H | E1 | E2 | E3 | E4 | Refrigerant | | | | | |
| | DTM = 7K Air mean = +2°C | DT1 = 8K (SC2) Air on = 0°C | | | DTM = 7K Air mean = +2°C | DT1 = 8K (SC2) Air on = 0°C | | | | | | | | | | | | | in | out | Hot gas | Drain | | |
| | kW | kW | m ³ /h | dB(A) | kW | kW | m ³ /h | dB(A) | m ² | dm ³ | kg | mm | mm | mm | mm | mm | mm | mm | mm | mm | mm | mm | NW" | |

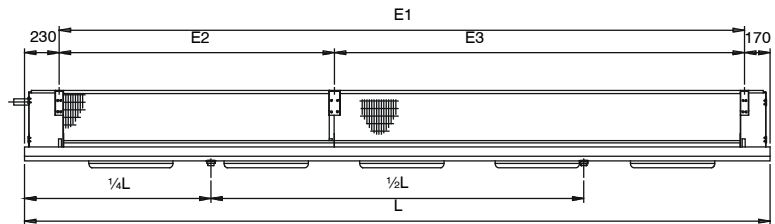
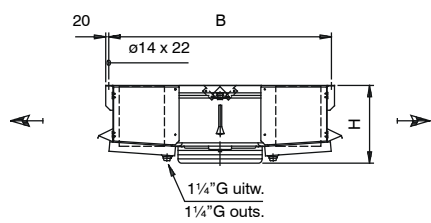

| | | | | | | | | | | | | | | | | | | | | | | |
|-----------|-------|------|-------|----|------|------|-------|----|-----|-----|-----|------|------|-----|------|------|------|--|----|----|------|----------|
| 8.4.45.10 | 34,0 | 29,9 | 20187 | 62 | 27,9 | 23,3 | 12871 | 52 | 175 | 60 | 372 | 2856 | 1630 | 520 | 2456 | | | | 42 | 16 | 4x19 | 2x1 1/4" |
| 1.4.45.10 | 41,5 | 34,6 | 19648 | 62 | 33,8 | 26,4 | 12483 | 52 | 219 | 76 | 429 | 2856 | 1830 | 520 | 2456 | | | | 42 | 22 | 4x19 | 2x1 1/4" |
| 8.4.50.10 | 52,4 | 45,6 | 29581 | 68 | 41,7 | 34,3 | 19651 | 64 | 262 | 90 | 533 | 4056 | 1680 | 520 | 3656 | 1828 | 1828 | | 42 | 22 | 4x19 | 2x1 1/4" |
| 1.4.50.10 | 64,1 | 52,6 | 29051 | 68 | 52,1 | 40,4 | 19276 | 64 | 328 | 114 | 613 | 4056 | 1880 | 520 | 3656 | 1828 | 1828 | | 54 | 22 | 4x35 | 2x1 1/4" |
| 8.4.56.10 | 74,2 | 64,5 | 41849 | 68 | 58,6 | 48,2 | 26666 | 58 | 364 | 126 | 661 | 4456 | 1740 | 620 | 4056 | 2028 | 2028 | | 54 | 22 | 4x35 | 2x1 1/4" |
| 1.4.56.10 | 90,8 | 74,4 | 41187 | 68 | 71,3 | 55,2 | 26227 | 58 | 456 | 156 | 762 | 4456 | 1940 | 620 | 4056 | 2028 | 2028 | | 54 | 22 | 4x35 | 2x1 1/4" |
| 8.4.63.10 | 89,8 | 78,2 | 51128 | 68 | 76,7 | 64,3 | 37529 | 63 | 437 | 150 | 737 | 4456 | 1810 | 720 | 4056 | 2028 | 2028 | | 54 | 22 | 4x35 | 2x1 1/4" |
| 1.4.63.10 | 110,0 | 90,4 | 50302 | 68 | 93,4 | 73,4 | 36874 | 63 | 547 | 188 | 854 | 4456 | 2010 | 720 | 4056 | 2028 | 2028 | | 54 | 28 | 4x35 | 2x1 1/4" |

| | | | | | | | | | | | | | | | | | | | | | | |
|-----------|-------|-------|-------|----|-------|------|-------|----|-----|-----|------|------|------|-----|------|------|------|--|----|----|------|----------|
| 8.5.50.10 | 65,4 | 56,9 | 36975 | 69 | 53,8 | 44,3 | 24562 | 65 | 328 | 114 | 651 | 4956 | 1680 | 520 | 4556 | 1828 | 2728 | | 54 | 22 | 4x35 | 4x1 1/4" |
| 1.5.50.10 | 80,0 | 65,9 | 36312 | 69 | 65,3 | 50,5 | 24093 | 65 | 410 | 142 | 748 | 4956 | 1880 | 520 | 4556 | 1828 | 2728 | | 54 | 22 | 4x35 | 4x1 1/4" |
| 8.5.56.10 | 88,9 | 78,0 | 52309 | 69 | 73,1 | 60,4 | 33331 | 58 | 455 | 156 | 808 | 5456 | 1740 | 620 | 5056 | 2028 | 3028 | | 54 | 22 | 4x35 | 4x1 1/4" |
| 1.5.56.10 | 108,9 | 90,9 | 51482 | 69 | 88,9 | 69,0 | 32783 | 58 | 569 | 196 | 934 | 5456 | 1940 | 620 | 5056 | 2028 | 3028 | | 54 | 28 | 4x35 | 4x1 1/4" |
| 8.5.63.10 | 112,4 | 97,8 | 63906 | 69 | 95,0 | 79,7 | 46909 | 63 | 547 | 188 | 901 | 5456 | 1810 | 720 | 5056 | 2028 | 3028 | | 64 | 28 | 4x35 | 4x1 1/4" |
| 1.5.63.10 | 137,6 | 112,6 | 62874 | 69 | 115,8 | 91,7 | 46091 | 63 | 683 | 234 | 1045 | 5456 | 2010 | 720 | 5056 | 2028 | 3028 | | 64 | 28 | 4x35 | 4x1 1/4" |

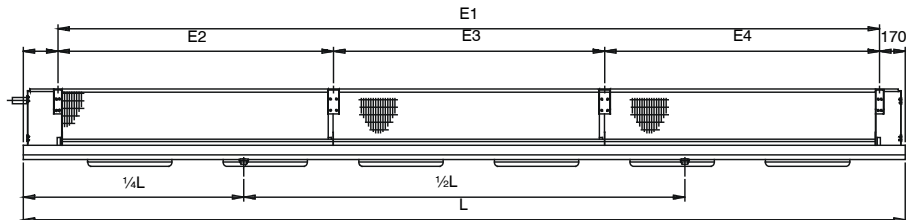
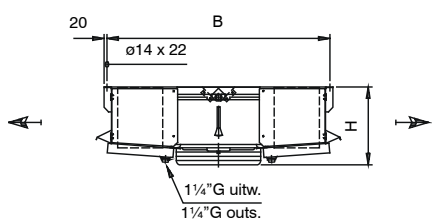

| | | | | | | | | | | | | | | | | | | | | | | |
|-----------|-------|-------|-------|----|-------|-------|-------|----|-----|-----|------|------|------|-----|------|------|------|------|----|----|------|----------|
| 8.6.50.10 | 73,9 | 65,0 | 44368 | 69 | 62,7 | 52,3 | 29474 | 65 | 393 | 136 | 767 | 5856 | 1680 | 520 | 5456 | 1828 | 1800 | 1828 | 54 | 22 | 4x35 | 4x1 1/4" |
| 1.6.50.10 | 94,8 | 77,3 | 43572 | 69 | 76,2 | 60,0 | 28911 | 65 | 492 | 170 | 885 | 5856 | 1880 | 520 | 5456 | 1828 | 1800 | 1828 | 54 | 28 | 4x35 | 4x1 1/4" |
| 8.6.56.10 | 111,5 | 96,8 | 62770 | 69 | 86,8 | 71,1 | 39995 | 59 | 547 | 188 | 958 | 6456 | 1740 | 620 | 6056 | 2028 | 2000 | 2028 | 64 | 28 | 4x35 | 4x1 1/4" |
| 1.6.56.10 | 136,5 | 111,4 | 61777 | 69 | 105,5 | 80,5 | 39340 | 59 | 683 | 234 | 1107 | 6456 | 1940 | 620 | 6056 | 2028 | 2000 | 2028 | 64 | 28 | 4x35 | 4x1 1/4" |
| 8.6.63.10 | 133,6 | 116,6 | 76686 | 69 | 115,6 | 96,9 | 56291 | 64 | 656 | 226 | 1069 | 6456 | 1810 | 720 | 6056 | 2028 | 2000 | 2028 | 64 | 28 | 4x35 | 4x1 1/4" |
| 1.6.63.10 | 165,4 | 135,3 | 75447 | 69 | 140,9 | 111,0 | 55308 | 64 | 820 | 282 | 1240 | 6456 | 2010 | 720 | 6056 | 2028 | 2000 | 2028 | 64 | 28 | 4x35 | 4x1 1/4" |

Pay attention to the relation capacity / air volume !!

* Sound pressure indication (LpA) at 3 m distance each air cooler (+/- 2 dB(A)) , free field conditions, according EN13487

DVS Electrical defrost

| Type | Fan | Light defrost | | | | | Heavy defrost | | | | |
|------|-----|---------------|----|------------------|----|-------|---------------|----|------------------|----|-------|
| | | Coil (230V) | | Drip tray (200V) | | Total | Coil (230V) | | Drip tray (200V) | | Total |
| | | number | kW | number | kW | kW | number | kW | number | kW | kW |



1 fan

| | | | | | | | | | | | |
|----------|------|--------|------|--------|------|------|--------|-------|--------|------|-------|
| 3.1.40.f | Ø400 | 1 (2x) | 1.26 | 1 (2x) | 1.36 | 2.62 | 2 (2x) | 2.52 | 1 (2x) | 1.36 | 3.88 |
| 4.1.40.f | | 1 (2x) | 1.26 | 1 (2x) | 1.36 | 2.62 | 2 (2x) | 2.52 | 1 (2x) | 1.36 | 3.88 |
| 6.1.40.f | | 2 (2x) | 2.52 | 1 (2x) | 1.36 | 3.88 | 3 (2x) | 3.78 | 1 (2x) | 1.36 | 5.14 |
| 8.1.40.f | | 2 (2x) | 2.52 | 1 (2x) | 1.36 | 3.88 | 3 (2x) | 3.78 | 1 (2x) | 1.36 | 5.14 |
| 1.1.40.f | | 3 (2x) | 3.78 | 1 (2x) | 1.56 | 5.34 | 4 (2x) | 5.04 | 1 (2x) | 1.56 | 6.60 |
| 3.1.45.f | Ø450 | 2 (2x) | 2.52 | 1 (2x) | 1.36 | 3.88 | 3 (2x) | 3.78 | 1 (2x) | 1.56 | 5.14 |
| 4.1.45.f | | 2 (2x) | 2.52 | 1 (2x) | 1.36 | 3.88 | 3 (2x) | 3.78 | 1 (2x) | 1.36 | 5.14 |
| 6.1.45.f | | 2 (2x) | 2.52 | 1 (2x) | 1.36 | 3.88 | 3 (2x) | 3.78 | 1 (2x) | 1.36 | 5.14 |
| 8.1.45.f | | 2 (2x) | 2.52 | 1 (2x) | 1.36 | 3.88 | 4 (2x) | 5.04 | 1 (2x) | 1.36 | 6.40 |
| 1.1.45.f | | 3 (2x) | 3.78 | 1 (2x) | 1.56 | 5.34 | 5 (2x) | 6.30 | 1 (2x) | 1.56 | 7.86 |
| 3.1.50.f | Ø500 | 2 (2x) | 3.56 | 1 (2x) | 1.76 | 5.32 | 3 (2x) | 5.34 | 1 (2x) | 1.76 | 7.10 |
| 4.1.50.f | | 2 (2x) | 3.56 | 1 (2x) | 1.76 | 5.32 | 3 (2x) | 5.34 | 1 (2x) | 1.76 | 7.10 |
| 6.1.50.f | | 2 (2x) | 3.56 | 1 (2x) | 1.76 | 5.32 | 3 (2x) | 5.34 | 1 (2x) | 1.76 | 7.10 |
| 8.1.50.f | | 2 (2x) | 3.56 | 1 (2x) | 1.76 | 5.32 | 4 (2x) | 7.12 | 1 (2x) | 1.76 | 8.88 |
| 1.1.50.f | | 3 (2x) | 5.34 | 1 (2x) | 1.96 | 7.30 | 5 (2x) | 8.90 | 1 (2x) | 1.96 | 10.86 |
| 3.1.56.f | Ø560 | 2 (2x) | 4.08 | 1 (2x) | 1.96 | 6.04 | 3 (2x) | 6.12 | 1 (2x) | 1.96 | 8.08 |
| 4.1.56.f | | 2 (2x) | 4.08 | 1 (2x) | 1.96 | 6.04 | 3 (2x) | 6.12 | 1 (2x) | 1.96 | 8.08 |
| 6.1.56.f | | 2 (2x) | 4.08 | 1 (2x) | 1.96 | 6.04 | 3 (2x) | 6.12 | 1 (2x) | 1.96 | 8.08 |
| 8.1.56.f | | 2 (2x) | 4.08 | 1 (2x) | 1.96 | 6.04 | 4 (2x) | 8.16 | 1 (2x) | 1.96 | 10.12 |
| 1.1.56.f | | 3 (2x) | 6.12 | 1 (2x) | 2.14 | 8.26 | 5 (2x) | 10.20 | 1 (2x) | 2.14 | 12.34 |
| 3.1.63.f | Ø630 | 2 (2x) | 4.08 | 1 (2x) | 1.96 | 6.04 | 3 (2x) | 6.12 | 1 (2x) | 1.96 | 8.08 |
| 4.1.63.f | | 2 (2x) | 4.08 | 1 (2x) | 1.96 | 6.04 | 3 (2x) | 6.12 | 1 (2x) | 1.96 | 8.08 |
| 6.1.63.f | | 2 (2x) | 4.08 | 1 (2x) | 1.96 | 6.04 | 3 (2x) | 6.12 | 1 (2x) | 1.96 | 8.08 |
| 8.1.63.f | | 3 (2x) | 6.12 | 1 (2x) | 1.96 | 6.04 | 5 (2x) | 10.20 | 1 (2x) | 1.96 | 12.16 |
| 1.1.63.f | | 3 (2x) | 6.12 | 1 (2x) | 2.14 | 8.26 | 5 (2x) | 10.20 | 1 (2x) | 2.14 | 12.34 |



2 fans

| | | | | | | | | | | | |
|----------|------|--------|-------|--------|------|-------|--------|-------|--------|------|-------|
| 3.2.40.f | Ø400 | 1 (2x) | 2.32 | 1 (2x) | 2.14 | 4.46 | 2 (2x) | 4.64 | 1 (2x) | 2.14 | 6.78 |
| 4.2.40.f | | 1 (2x) | 2.32 | 1 (2x) | 2.14 | 4.46 | 2 (2x) | 4.64 | 1 (2x) | 2.14 | 6.78 |
| 6.2.40.f | | 2 (2x) | 4.64 | 1 (2x) | 2.14 | 6.78 | 3 (2x) | 6.96 | 1 (2x) | 2.14 | 9.10 |
| 8.2.40.f | | 2 (2x) | 4.64 | 1 (2x) | 2.14 | 6.78 | 3 (2x) | 6.96 | 1 (2x) | 2.14 | 9.10 |
| 1.2.40.f | | 3 (2x) | 6.96 | 1 (2x) | 2.34 | 9.30 | 4 (2x) | 9.28 | 1 (2x) | 2.34 | 11.62 |
| 3.2.45.f | Ø450 | 2 (2x) | 4.64 | 1 (2x) | 2.14 | 6.78 | 3 (2x) | 6.96 | 1 (2x) | 2.14 | 9.10 |
| 4.2.45.f | | 2 (2x) | 4.64 | 1 (2x) | 2.14 | 6.78 | 3 (2x) | 6.96 | 1 (2x) | 2.14 | 9.10 |
| 6.2.45.f | | 2 (2x) | 4.64 | 1 (2x) | 2.14 | 6.78 | 3 (2x) | 6.96 | 1 (2x) | 2.14 | 9.10 |
| 8.2.45.f | | 2 (2x) | 4.64 | 1 (2x) | 2.14 | 6.78 | 4 (2x) | 9.28 | 1 (2x) | 2.14 | 11.42 |
| 1.2.45.f | | 3 (2x) | 6.96 | 1 (2x) | 2.34 | 9.30 | 5 (2x) | 11.60 | 1 (2x) | 2.34 | 13.94 |
| 3.2.50.f | Ø500 | 2 (2x) | 7.24 | 1 (2x) | 2.92 | 10.16 | 3 (2x) | 10.86 | 1 (2x) | 2.92 | 13.78 |
| 4.2.50.f | | 2 (2x) | 7.24 | 1 (2x) | 2.92 | 10.16 | 3 (2x) | 10.86 | 1 (2x) | 2.92 | 13.78 |
| 6.2.50.f | | 2 (2x) | 7.24 | 1 (2x) | 2.92 | 10.16 | 3 (2x) | 10.86 | 1 (2x) | 2.92 | 13.78 |
| 8.2.50.f | | 3 (2x) | 7.24 | 1 (2x) | 2.92 | 10.16 | 4 (2x) | 14.48 | 1 (2x) | 2.92 | 17.40 |
| 1.2.50.f | | 3 (2x) | 10.86 | 1 (2x) | 3.12 | 13.98 | 5 (2x) | 18.10 | 1 (2x) | 3.12 | 21.22 |
| 3.2.56.f | Ø560 | 2 (2x) | 7.76 | 1 (2x) | 3.34 | 11.10 | 3 (2x) | 11.64 | 1 (2x) | 3.34 | 14.98 |
| 4.2.56.f | | 2 (2x) | 7.76 | 1 (2x) | 3.34 | 11.10 | 3 (2x) | 11.64 | 1 (2x) | 3.34 | 14.98 |
| 6.2.56.f | | 2 (2x) | 7.76 | 1 (2x) | 3.34 | 11.10 | 3 (2x) | 11.64 | 1 (2x) | 3.34 | 14.98 |
| 8.2.56.f | | 3 (2x) | 7.76 | 1 (2x) | 3.34 | 11.10 | 4 (2x) | 15.52 | 1 (2x) | 3.34 | 18.86 |
| 1.2.56.f | | 3 (2x) | 11.64 | 1 (2x) | 3.52 | 15.16 | 5 (2x) | 19.40 | 1 (2x) | 3.52 | 22.92 |
| 3.2.63.f | Ø630 | 2 (2x) | 7.76 | 1 (2x) | 3.34 | 11.10 | 3 (2x) | 11.64 | 1 (2x) | 3.34 | 14.98 |
| 4.2.63.f | | 2 (2x) | 7.76 | 1 (2x) | 3.34 | 11.10 | 3 (2x) | 11.64 | 1 (2x) | 3.34 | 14.98 |
| 6.2.63.f | | 2 (2x) | 7.76 | 1 (2x) | 3.34 | 11.10 | 3 (2x) | 11.64 | 1 (2x) | 3.34 | 14.98 |
| 8.2.63.f | | 3 (2x) | 11.64 | 1 (2x) | 3.34 | 14.98 | 5 (2x) | 19.40 | 1 (2x) | 3.34 | 22.74 |
| 1.2.63.f | | 3 (2x) | 11.64 | 1 (2x) | 3.52 | 15.16 | 5 (2x) | 19.40 | 1 (2x) | 3.52 | 22.92 |



3 fans

| | | | | | | | | | | | |
|----------|------|--------|-------|--------|------|-------|---------|-------|--------|------|-------|
| 3.3.45.f | Ø450 | 2 (2x) | 7.24 | 1 (2x) | 2.92 | 10.16 | 3 (2x) | 10.86 | 1 (2x) | 2.95 | 13.78 |
| 4.3.45.f | | 2 (2x) | 7.24 | 1 (2x) | 2.92 | 10.16 | 3 (2x) | 10.86 | 1 (2x) | 2.95 | 13.78 |
| 6.3.45.f | | 2 (2x) | 7.24 | 1 (2x) | 2.92 | 10.16 | 3 (2x) | 10.86 | 1 (2x) | 2.92 | 13.78 |
| 8.3.45.f | | 2 (2x) | 7.24 | 1 (2x) | 2.92 | 10.16 | 4 (2x) | 14.48 | 1 (2x) | 2.92 | 17.40 |
| 1.3.45.f | | 3 (2x) | 10.86 | 1 (2x) | 3.12 | 13.98 | 5 (2x) | 18.10 | 1 (2x) | 3.12 | 21.22 |
| 3.3.50.f | Ø500 | 4 (2x) | 9.84 | 2 (2x) | 4.28 | 14.12 | 6 (2x) | 14.76 | 2 (2x) | 4.28 | 19.04 |
| 4.3.50.f | | 4 (2x) | 9.84 | 2 (2x) | 4.28 | 14.12 | 6 (2x) | 14.76 | 2 (2x) | 4.28 | 19.04 |
| 6.3.50.f | | 4 (2x) | 9.84 | 2 (2x) | 4.28 | 14.12 | 6 (2x) | 14.76 | 2 (2x) | 4.28 | 19.04 |
| 8.3.50.f | | 4 (2x) | 9.84 | 2 (2x) | 4.28 | 14.12 | 8 (2x) | 19.68 | 2 (2x) | 4.28 | 23.96 |
| 1.3.50.f | | 6 (2x) | 14.76 | 2 (2x) | 4.28 | 19.04 | 10 (2x) | 24.60 | 2 (2x) | 4.28 | 28.88 |
| 3.3.56.f | Ø560 | 4 (2x) | 10.32 | 2 (2x) | 4.68 | 15.00 | 6 (2x) | 15.48 | 2 (2x) | 4.68 | 20.16 |
| 4.3.56.f | | 4 (2x) | 10.32 | 2 (2x) | 4.68 | 15.00 | 6 (2x) | 15.48 | 2 (2x) | 4.68 | 20.16 |
| 6.3.56.f | | 4 (2x) | 10.32 | 2 (2x) | 4.68 | 15.00 | 6 (2x) | 15.48 | 2 (2x) | 4.68 | 20.16 |
| 8.3.56.f | | 4 (2x) | 10.32 | 2 (2x) | 4.68 | 15.00 | 8 (2x) | 20.64 | 2 (2x) | 4.68 | 25.32 |
| 1.3.56.f | | 6 (2x) | 15.48 | 2 (2x) | 4.68 | 20.16 | 10 (2x) | 25.80 | 2 (2x) | 4.68 | 30.48 |
| 3.3.63.f | Ø630 | 4 (2x) | 10.32 | 2 (2x) | 4.68 | 15.00 | 6 (2x) | 15.48 | 2 (2x) | 4.68 | 20.16 |
| 4.3.63.f | | 4 (2x) | 10.32 | 2 (2x) | 4.68 | 15.00 | 6 (2x) | 15.48 | 2 (2x) | 4.68 | 20.16 |
| 6.3.63.f | | 4 (2x) | 10.32 | 2 (2x) | 4.68 | 15.00 | 6 (2x) | 15.48 | 2 (2x) | 4.68 | 20.16 |
| 8.3.63.f | | 6 (2x) | 15.48 | 2 (2x) | 4.68 | 20.16 | 10 (2x) | 25.80 | 2 (2x) | 4.68 | 30.48 |
| 1.3.63.f | | 6 (2x) | 15.48 | 2 (2x) | 4.68 | 20.16 | 10 (2x) | 25.80 | 2 (2x) | 4.68 | 30.48 |

f = fin spacing

DVS Electrical defrost

| Type | Fan | Light defrost | | | | | Heavy defrost | | | | |
|------|-----|---------------|----|------------------|----|-------|---------------|----|------------------|----|-------|
| | | Coil (230V) | | Drip tray (200V) | | Total | Coil (230V) | | Drip tray (200V) | | Total |
| | | number | kW | number | kW | kW | number | kW | number | kW | kW |



4 fans

| | | | | | | | | | | | |
|----------|------|--------|-------|--------|------|-------|---------|-------|--------|------|-------|
| 3.4.45.f | Ø450 | 2 (2x) | 8.80 | 1 (2x) | 3.74 | 12.54 | 3 (2x) | 13.20 | 1 (2x) | 3.74 | 16.94 |
| 4.4.45.f | | 2 (2x) | 8.80 | 1 (2x) | 3.74 | 12.54 | 3 (2x) | 13.20 | 1 (2x) | 3.74 | 16.94 |
| 6.4.45.f | | 2 (2x) | 8.80 | 1 (2x) | 3.74 | 12.54 | 3 (2x) | 13.20 | 1 (2x) | 3.74 | 16.94 |
| 8.4.45.f | | 2 (2x) | 8.80 | 1 (2x) | 3.74 | 12.54 | 4 (2x) | 17.60 | 1 (2x) | 3.74 | 21.34 |
| 1.4.45.f | | 3 (2x) | 13.20 | 1 (2x) | 3.92 | 17.12 | 5 (2x) | 22.00 | 1 (2x) | 3.92 | 25.92 |
| 3.4.50.f | Ø500 | 4 (2x) | 12.40 | 2 (2x) | 5.48 | 17.88 | 6 (2x) | 18.60 | 2 (2x) | 5.48 | 24.08 |
| 4.4.50.f | | 4 (2x) | 12.40 | 2 (2x) | 5.48 | 17.88 | 6 (2x) | 18.60 | 2 (2x) | 5.48 | 24.08 |
| 6.4.50.f | | 4 (2x) | 12.40 | 2 (2x) | 5.48 | 17.88 | 6 (2x) | 18.60 | 2 (2x) | 5.48 | 24.08 |
| 8.4.50.f | | 4 (2x) | 12.40 | 2 (2x) | 5.48 | 17.88 | 8 (2x) | 24.80 | 2 (2x) | 5.48 | 30.28 |
| 1.4.50.f | | 6 (2x) | 18.60 | 2 (2x) | 5.48 | 24.08 | 10 (2x) | 31.00 | 2 (2x) | 5.48 | 36.48 |
| 3.4.56.f | Ø560 | 4 (2x) | 14.48 | 2 (2x) | 5.84 | 20.32 | 6 (2x) | 21.72 | 2 (2x) | 5.84 | 27.56 |
| 4.4.56.f | | 4 (2x) | 14.48 | 2 (2x) | 5.84 | 20.32 | 6 (2x) | 21.72 | 2 (2x) | 5.84 | 27.56 |
| 6.4.56.f | | 4 (2x) | 14.48 | 2 (2x) | 5.84 | 20.32 | 6 (2x) | 21.72 | 2 (2x) | 5.84 | 27.56 |
| 8.4.56.f | | 4 (2x) | 14.48 | 2 (2x) | 5.84 | 20.32 | 8 (2x) | 28.96 | 2 (2x) | 5.84 | 34.80 |
| 1.4.56.f | | 6 (2x) | 21.72 | 2 (2x) | 5.84 | 27.56 | 10 (2x) | 36.20 | 2 (2x) | 5.84 | 42.04 |
| 3.4.63.f | Ø630 | 4 (2x) | 14.48 | 2 (2x) | 5.84 | 20.32 | 6 (2x) | 21.72 | 2 (2x) | 5.84 | 27.56 |
| 4.4.63.f | | 4 (2x) | 14.48 | 2 (2x) | 5.84 | 20.32 | 6 (2x) | 21.72 | 2 (2x) | 5.84 | 27.56 |
| 6.4.63.f | | 4 (2x) | 14.48 | 2 (2x) | 5.84 | 20.32 | 6 (2x) | 21.72 | 2 (2x) | 5.84 | 27.56 |
| 8.4.63.f | | 6 (2x) | 21.72 | 2 (2x) | 5.84 | 27.56 | 10 (2x) | 36.20 | 2 (2x) | 5.84 | 42.04 |
| 1.4.63.f | | 6 (2x) | 21.72 | 2 (2x) | 5.84 | 27.56 | 10 (2x) | 36.20 | 2 (2x) | 5.84 | 42.04 |



5 fans

| | | | | | | | | | | | |
|----------|------|--------|-------|--------|------|-------|---------|-------|--------|------|-------|
| 3.5.50.f | Ø500 | 4 (2x) | 15.52 | 2 (2x) | 6.68 | 22.20 | 6 (2x) | 23.28 | 2 (2x) | 6.68 | 29.96 |
| 4.5.50.f | | 4 (2x) | 15.52 | 2 (2x) | 6.68 | 22.20 | 6 (2x) | 23.28 | 2 (2x) | 6.68 | 29.96 |
| 6.5.50.f | | 4 (2x) | 15.52 | 2 (2x) | 6.68 | 22.20 | 6 (2x) | 23.28 | 2 (2x) | 6.68 | 29.96 |
| 8.5.50.f | | 4 (2x) | 15.52 | 2 (2x) | 6.68 | 22.20 | 8 (2x) | 31.04 | 2 (2x) | 6.68 | 37.72 |
| 1.5.50.f | | 6 (2x) | 23.28 | 2 (2x) | 6.68 | 29.96 | 10 (2x) | 38.80 | 2 (2x) | 6.68 | 45.48 |
| 3.5.56.f | Ø560 | 4 (2x) | 17.60 | 2 (2x) | 7.04 | 24.64 | 6 (2x) | 26.40 | 2 (2x) | 7.04 | 33.44 |
| 4.5.56.f | | 4 (2x) | 17.60 | 2 (2x) | 7.04 | 24.64 | 6 (2x) | 26.40 | 2 (2x) | 7.04 | 33.44 |
| 6.5.56.f | | 4 (2x) | 17.60 | 2 (2x) | 7.04 | 24.64 | 6 (2x) | 26.40 | 2 (2x) | 7.04 | 33.44 |
| 8.5.56.f | | 4 (2x) | 17.60 | 2 (2x) | 7.04 | 24.64 | 8 (2x) | 35.20 | 2 (2x) | 7.04 | 42.24 |
| 1.5.56.f | | 6 (2x) | 26.40 | 2 (2x) | 7.04 | 33.44 | 10 (2x) | 44.00 | 2 (2x) | 7.04 | 51.04 |
| 3.5.63.f | Ø630 | 4 (2x) | 17.60 | 2 (2x) | 7.04 | 24.64 | 6 (2x) | 26.40 | 2 (2x) | 7.04 | 33.44 |
| 4.5.63.f | | 4 (2x) | 17.60 | 2 (2x) | 7.04 | 24.64 | 6 (2x) | 26.40 | 2 (2x) | 7.04 | 33.44 |
| 6.5.63.f | | 4 (2x) | 17.60 | 2 (2x) | 7.04 | 24.64 | 6 (2x) | 26.40 | 2 (2x) | 7.04 | 33.44 |
| 8.5.63.f | | 6 (2x) | 26.40 | 2 (2x) | 7.04 | 33.44 | 10 (2x) | 44.00 | 2 (2x) | 7.04 | 51.04 |
| 1.5.63.f | | 6 (2x) | 26.40 | 2 (2x) | 7.04 | 33.44 | 10 (2x) | 44.00 | 2 (2x) | 7.04 | 51.04 |



6 fans

| | | | | | | | | | | | |
|----------|------|--------|-------|--------|------|-------|---------|-------|--------|------|-------|
| 3.6.50.f | Ø500 | 4 (2x) | 18.64 | 2 (2x) | 7.84 | 26.48 | 6 (2x) | 27.96 | 2 (2x) | 7.84 | 35.80 |
| 4.6.50.f | | 4 (2x) | 18.64 | 2 (2x) | 7.84 | 26.48 | 6 (2x) | 27.96 | 2 (2x) | 7.84 | 35.80 |
| 6.6.50.f | | 4 (2x) | 18.64 | 2 (2x) | 7.84 | 26.48 | 6 (2x) | 27.96 | 2 (2x) | 7.84 | 35.80 |
| 8.6.50.f | | 4 (2x) | 18.64 | 2 (2x) | 7.84 | 26.48 | 8 (2x) | 37.28 | 2 (2x) | 7.84 | 45.12 |
| 1.6.50.f | | 6 (2x) | 27.96 | 2 (2x) | 7.84 | 35.80 | 10 (2x) | 46.60 | 2 (2x) | 7.84 | 54.44 |
| 3.6.56.f | Ø560 | 4 (2x) | 20.80 | 2 (2x) | 8.32 | 29.12 | 6 (2x) | 31.20 | 2 (2x) | 8.32 | 39.52 |
| 4.6.56.f | | 4 (2x) | 20.80 | 2 (2x) | 8.32 | 29.12 | 6 (2x) | 31.20 | 2 (2x) | 8.32 | 39.52 |
| 6.6.56.f | | 4 (2x) | 20.80 | 2 (2x) | 8.32 | 29.12 | 6 (2x) | 31.20 | 2 (2x) | 8.32 | 39.52 |
| 8.6.56.f | | 4 (2x) | 20.80 | 2 (2x) | 8.32 | 29.12 | 8 (2x) | 41.60 | 2 (2x) | 8.32 | 49.92 |
| 1.6.56.f | | 6 (2x) | 31.40 | 2 (2x) | 8.32 | 39.52 | 10 (2x) | 52.00 | 2 (2x) | 8.32 | 60.32 |
| 3.6.63.f | Ø630 | 4 (2x) | 20.80 | 2 (2x) | 8.32 | 29.12 | 6 (2x) | 31.20 | 2 (2x) | 8.32 | 39.52 |
| 4.6.63.f | | 4 (2x) | 20.80 | 2 (2x) | 8.32 | 29.12 | 6 (2x) | 31.20 | 2 (2x) | 8.32 | 39.52 |
| 6.6.63.f | | 4 (2x) | 20.80 | 2 (2x) | 8.32 | 29.12 | 6 (2x) | 31.20 | 2 (2x) | 8.32 | 39.52 |
| 8.6.63.f | | 6 (2x) | 31.40 | 2 (2x) | 8.32 | 39.52 | 10 (2x) | 52.00 | 2 (2x) | 8.32 | 60.32 |
| 1.6.63.f | | 6 (2x) | 31.70 | 2 (2x) | 8.32 | 39.52 | 10 (2x) | 52.00 | 2 (2x) | 8.32 | 60.32 |

f = fin spacing

Goedhart standard product information

Goedhart standard aircooler overview



VCI



DVS/DRS/DZS



ZGB/ZGZ



PAC



FC38



ZFB/ZFZ



Goedhart air cooler for every application

For Contractors and Original Equipment Manufacturers (OEM) related to the industrial refrigeration industry, GEA Goedhart B.V. offers an unlimited range of air coolers and air cooled condensers in several configurations.

Depending on the application, the optimum configuration will be selected in close cooperation with our customers.

Configurations

The following material combinations are available in various tube pitches and various fin spacing:

| Tube material | Tube configuration | Fin material |
|------------------------------------|---------------------|------------------------------------|
| Copper (Cu) | 38x33, 50x50, 60x60 | Aluminium (Al) |
| Stainless steel (Stst) | 38x33, 50x50, 60x60 | Aluminium (Al) |
| Stainless steel (Stst) | 50x50 | Stainless steel (Stst) |
| Aluminium (Al) | 60x60 | Aluminium (Al) |
| Hot dipped galvanized steel (FeZn) | 60x60, 75x75 | Hot dipped galvanized steel (FeZn) |

Options on aluminium fins

- Goldlack coated fins
- Seawater resistant aluminium fins (AlMg)

Applications

| Cooling | Freezing |
|------------------------------------|------------------------------------|
| Cold stores / Distribution centres | Cold stores / Distribution centres |
| Food processing rooms | Tunnel / spiral freezers |
| Fruit storage | Slaughter houses |
| Banana ripening storage | Automotive testing rooms |
| Greenhouse conditioning | Ski domes |

Pressure Equipment Directive (P.E.D.)

All aircoolers produced by Goedhart comply with the Pressure Equipment Directive 97/23/EC. PED certificates can be downloaded from www.goedhart.nl.





GEA Heat Exchangers

GEA Goedhart B.V.

Nijverheidsweg 6, 4695 RC Sint Maartensdijk
the Netherlands
Phone +31 (0)166 665 665, Fax+31 (0)166 663 698
www.goedhart.nl
info.goedhart.nl@geagroup.com

GEA Heat Exchangers

GEA Goedhart s.r.o.

Kostomlátecká 180, 288 26 Nymburk
Czech Republic
Phone +420 (0)325 819 951, Fax+420 (0)325 519 952
www.goedhart.cz
goedhart.cz@geagroup.com

03.01.2.009.doc 2010-01 / Subject to modification

All offers, contracts, deliveries and other legal relations from GEA Goedhart B.V. are subject to the latest version of our general sales and delivery conditions as filed at the Chamber of Commerce in Middelburg - The Netherlands

Applicability of the general conditions put forward by any buyer is rejected explicitly by GEA Goedhart B.V.